



Maritime &
Coastguard
Agency

Code of Safe Working Practices for Merchant Seafarers

**2015 edition – Consolidated Edition May 2018
(incorporating Amendments 1 and 2)**

© Crown Copyright 2018. Published for the Maritime and Coastguard Agency under licence from the Controller of Her Majesty's Stationery Office.

Second impression 2019

You may re-use this document/publication (not including logos) free of charge in any format or medium, under the terms of the Open Government Licence. To view this licence, visit <http://www.nationalarchives.gov.uk/doc/open-government-licence/version/3/>, write to the Information Policy Team, The National Archives, Kew, Richmond, Surrey TW9 4DU or email: psi@nationalarchives.gsi.gov.uk.

ISBN 9780115535901



Published by TSO (The Stationery Office), part of Williams Lea Tag, and available from:

Online

www.tsoshop.co.uk

Mail, Telephone, Fax & Email

TSO

PO Box 29, Norwich, NR3 1GN

Telephone orders/General enquiries: 0333 202 5070

Fax orders: 0333 202 5080

Email: customer.services@tso.co.uk

Textphone 0333 202 5077

TSO@Blackwell and other Accredited Agents

Standing order service

A standing order for class 03.03.028 will ensure that you are supplied automatically with all supplements/amendments/new editions of this title as they are issued in paper format.

The benefits to you are:

- automatic supply on publication
- no need for time consuming research, telephone calls or scanning of publication lists
- saving on the need and costs of placing individual orders

We can supply a wide range of publications on standing order, from individual annual publications to all publications on a selected subject. If you do not already use this service, or think you are not using it to its full capability, why not contact us and discuss your requirements?

TSO

Standing Order Department

PO Box 29

St Crispins, Duke Street

Norwich NR3 1GN

Tel 0870 600 5522; Fax 0870 600 5533

Email: subscription@tso.co.uk

Blank page

Numbering, replacement and control of pages

The page numbering system contained within this Code follows the Quality Management System for Documentation procedures currently in use within the Maritime and Coastguard Agency.

Each page is numbered on the inside bottom edge and contains:

- the MCA identifier for this Code – i.e. MSCP01
- the number of the chapter/appendix – e.g. Ch1, Ap1
- the revision status of that chapter/appendix and page – e.g. Rev1.01
- the page number within the chapter – e.g. Page 2

The first page of each chapter/appendix indicates the total number of pages within it, e.g. Page 1 of 12. This enables the user to check that all the pages within that chapter/appendix are intact. Where pages need to be added to or subtracted from a chapter/appendix, the first page of that chapter/appendix will also be revised to show the new number of pages within it.

The page numbering in respect of page 1 of Chapter 4, for example, would be: MSCP01/Ch4/Rev1.01/Page 1 of 10

Where additional pages are added within the chapter/appendix, but the whole chapter/appendix is not replaced, the new page will be numbered: e.g. Page 3A

Pages that do not carry any text carry the words: 'Blank Page'

The Code contains an amendment sheet that provides the current revision status of amendments, chapters/appendices and pages (an example appears below) against which the revision status may be checked

Page revisions are indicated by a change in the number **after** the decimal point: e.g. Rev1.02, Rev1.03, etc., while chapter/appendix revisions are indicated by a change in the number **before** the decimal point: e.g. Rev2.01, Rev3.01, etc. (page revision reverts to 01)

Blank page

Sample amendment sheet (first issue)

Amendment 00

September 2015

Chapters	Pages	Revision status
1	All	1.01
2	All	1.01
3	All	1.01
4	All	1.01
5	All	1.01
6	All	1.01

Sample amendment sheet (second issue)

(The following is an example of an amendment sheet where pages 4–10 of Chapter 1 and the whole of Chapter 5 have been revised.)

Amendment 01

September 2015

Chapters	Pages	Revision status
1	1–3	1.01
	4–10	1.02
	11–16	1.01
2	All	1.01
3	All	1.01
4	All	1.01
5	All	2.01
6	All	1.01

Blank page

Code of Safe Working Practices for Merchant Seafarers

MSCP01

2015 edition

Chapters	Pages	Revision status
Contents	1	1.02
Contents	2	1.01
Contents	3	1.02
Contents	4	1.03
Contents	5-6	1.01
Contents	7-8	1.02
Contents	9	1.03
Contents	10	1.01
Contents	11	1.03
Contents	12	1.02
0	ALL	1.01
1	1-18	1.01
1	19-20	1.02
1	21-24	1.01
1	25	1.02
1	26-28	1.01
2	ALL	1.01
3	1-2	1.01
3	3	1.02
3	4-9	1.01
3	10-10D	1.02
4	1	1.02
4	2-3	1.01
4	4	1.02
4	5	1.02
4	6-12	1.01
5	1-2	1.01
5	3	1.02
5	4	1.01
6	ALL	1.01
7	1-4	1.01
7	5	1.02
7	6	1.01
8	1-2	1.02
8	3-12	1.01
9	1	1.02
9	2-8	1.01
9	9	1.02
9	10	1.01

Chapters	Pages	Revision status
9	11	1.02
9	12-18	1.01
10	1-7	1.01
10	8	1.02
10	9	1.01
10	10	1.02
11	1	1.02
11	2	1.01
11	3	1.03
11	4-6B	1.02
11	7-12	1.01
11	13	1.02
11	14	1.01
12	1-2	1.01
12	3	1.02
12	4-9	1.01
12	10-11	1.02
12	12	1.01
12	13	1.02
12	14-16	1.01
12	17	1.02
12	18	1.01
13	1-2	1.01
13	3	1.02
13	4-6	1.01
13	7	1.02
13	8-13	1.01
13	14	1.02
13	15-22	1.01
14	ALL	1.01
15	1-6	1.01
15	7-10B	1.02
15	11-13	1.01
15	14	1.02
15	15-16	1.01
15	17-18	1.02
15	19-20	1.01
16	ALL	1.01
17	1	1.02
17	2	1.01
17	3-7	1.02
17	8	1.01
17	9	1.02

Chapters	Pages	Revision status
17	10-16	1.01
18	1	1.01
18	2	1.02
18	3-9	1.01
18	10	1.02
18	11-16	1.01
18	17	1.02
18	18	1.01
18	19-20	1.02
18	21-26	1.01
19	1	1.02
19	2	1.01
19	3	1.02
19	4	1.01
19	5	1.02
19	6-7	1.01
19	8	1.02
19	9-16	1.01
19	17-19	1.02
19	20-36	1.01
20	1	1.01
20	2-4B	1.02
20	5-15	1.01
20	16	1.02
20	17-26	1.01
21	1-7	1.01
21	8	1.02
21	9-10	1.01
22	1-2	1.01
22	3-4	1.02
22	5	1.01
22	6	1.02
22	7-8	1.02
22	9	1.01
22	10-12	1.02
22	13-14	1.01
23	1	1.02
23	2-4	1.01
23	5-6B	1.02
23	7-10	1.01
24	1	1.03
21	2-10	1.02
24	11-16	1.01

Chapters	Pages	Revision status
25	ALL	1.01
26	1-8	1.02
26	9-12	1.01
27	1-8	1.01
27	9	1.02
27	10	1.01
28	1-3	1.01
28	4	1.02
28	5-6	1.01
28	7	1.02
28	8	1.01
28	9-11	1.02
28	12	1.01
29	ALL	1.01
30	1	1.01
30	2-3	1.02
30	4	1.01
31	1	1.01
31	2	1.03
31	3	1.02
31	4	1.01
31	5	1.02
31	6-12	1.01
32	ALL	1.01
33	ALL	1.01
Appendix 1	1-2	2.01
Appendix 1	3	2.02
Appendix 1	4	2.01
Appendix 1	5	2.02
Appendix 1	6-9	2.01
Appendix 1	10	2.02
Appendix 1	11-12	2.01
Appendix 2	1-8	2.02
Appendix 2	9-10	2.01
Appendix 3	ALL	2.01
Appendix 4	1-2	1.01
Appendix 4	3	1.02
Appendix 4	4	1.01
Index	ALL	3.01

CONTENTS

About this Code

Chapter 1 MANAGING OCCUPATIONAL HEALTH AND SAFETY

- 1.1 Introduction
- 1.2 What does a safe working culture look like?
- Annex 1.1 Management of change
- Annex 1.2 Five steps to risk assessment

Chapter 2 SAFETY INDUCTION

- 2.1 General
- 2.2 Emergency procedures and fire precautions
- 2.3 Accidents and medical emergencies
- 2.4 Health and hygiene
- 2.5 Good housekeeping
- 2.6 Environmental responsibilities
- 2.7 Occupational health and safety
- 2.8 Company and worker responsibilities
- 2.9 Consultation procedures

Chapter 3 LIVING ON BOARD

- 3.1 General
- 3.2 Fitness, health and hygiene
- 3.3 Smoking
- 3.4 Medication
- 3.5 Malaria
- 3.6 Avoiding the effects of fatigue (tiredness)
- 3.7 Working in hot or sunny climates and hot environments
- 3.8 Working in cold climates and environments
- 3.9 Working clothes
- 3.10 Shipboard housekeeping
- 3.11 Substances hazardous to health
- 3.12 Common personal injuries
- 3.13 Sunglasses
- 3.14 Risk from sharps

Chapter 4 EMERGENCY DRILLS AND PROCEDURES

- 4.1 Musters and drills
- 4.2 Fire drills
- 4.3 Action in the event of fire
- 4.4 Abandon ship drills
- 4.5 Action in the event of abandoning ship
- 4.6 Man overboard drills
- 4.7 Action in the event of man overboard
- 4.8 Dangerous (enclosed) space drills
- 4.9 Action in the event of a dangerous space emergency
- 4.10 Assisting a casualty
- 4.11 Drills for leakage and spillage
- 4.12 Action in the event of a leakage or spillage

Chapter 5 FIRE PRECAUTIONS

- 5.1 General
- 5.2 Smoking
- 5.3 Electrical and other fittings
- 5.4 Spontaneous combustion
- 5.5 Machinery spaces
- 5.6 Galleys

Chapter 6 SECURITY ON BOARD

- 6.1 Introduction
- 6.2 Ship security plans
- 6.3 Security levels
- 6.4 Precautions
- 6.5 Terrorism
- 6.6 Stowaways
- 6.7 Piracy and armed robbery
- 6.8 Smuggling
- 6.9 Personnel joining and leaving the vessel

Chapter 7 HEALTH SURVEILLANCE

- 7.1 Duty of employers
- 7.2 Purpose of health surveillance
- 7.3 Application
- 7.4 What to do
- 7.5 Seafarers
- 7.6 Managing health surveillance
- 7.7 Additional practical guidance on health surveillance for exposure to biological agents
- 7.8 Reporting of occupational diseases

Chapter 8 PERSONAL PROTECTIVE EQUIPMENT

- 8.1 Introduction
- 8.2 General requirements
- 8.3 Seafarer duties
- 8.4 Types of equipment
- 8.5 Head protection
- 8.6 Hearing protection
- 8.7 Face and eye protection
- 8.8 Respiratory protective equipment
- 8.9 Hand and foot protection
- 8.10 Protection from falls
- 8.11 Body protection
- 8.12 Protection against drowning

Chapter 9 SAFETY SIGNS AND THEIR USE

- 9.1 Introduction
- 9.2 Duty to display signs
- 9.3 Role of the seafarer
- 9.4 Signs and notices
- 9.5 Occasional signs
- 9.6 Electrical wiring
- 9.7 Gas cylinders
- 9.8 Pipelines
- 9.9 Portable fire extinguishers
- Annex 9.1 Safety signs as required by the Merchant Shipping and Fishing Vessels (Safety Signs and Signals) Regulations 2001 and MGN 556(M+F)

Chapter 10 MANUAL HANDLING

- 10.1 Introduction
- 10.2 General
- 10.3 Role of the Company
- 10.4 Good manual-handling techniques
- Annex 10.1 Factors to be considered

Chapter 11 SAFE MOVEMENT ON BOARD SHIP

- 11.1 Introduction
- 11.2 General principles
- 11.3 Drainage
- 11.4 Transit areas
- 11.5 Lighting
- 11.6 Guarding of openings
- 11.7 Watertight doors

- 11.8 Stairways, ladders and portable ladders
- 11.9 Shipboard vehicles
- 11.10 Entry into dangerous (enclosed) spaces
- 11.11 Working on deck while ship is at sea
- 11.12 Adverse weather
- 11.13 General advice to seafarers
- Annex 11.1 Standards for hold access
- Annex 11.2 Standards for lighting

Chapter 12 NOISE, VIBRATION AND OTHER PHYSICAL AGENTS

- 12.1 General advice
- 12.2 Prevention or control of exposure to a physical agent
- 12.3 Consultation
- 12.4 Seafarer information and training
- 12.5 Noise: introduction
- 12.6 Assessing exposure to noise
- 12.7 Risk assessment: noise
- 12.8 Health surveillance: noise
- 12.9 Noise arising from music and entertainment
- 12.10 Types of vibration and their effects
- 12.11 Exposure limits set by the vibration regulations
- 12.12 Determining vibration levels
- 12.13 Mitigation
- 12.14 Mitigation: hand–arm vibration
- 12.15 Mitigation: whole-body vibration
- 12.16 Health surveillance and health monitoring: vibration
- 12.17 Additional guidance
- 12.18 Other physical agents
- Annex 12.1 Examples of typical dB(A) levels
- Annex 12.2 Daily exposure to different sound levels
- Annex 12.3 Personal hearing protection

Chapter 13 SAFETY OFFICIALS

- 13.1 Introduction
- 13.2 Employer duties
- 13.3 Company duties
- 13.4 Duties of safety officers
- 13.5 Powers of safety representatives
- 13.6 Advice to safety representatives
- 13.7 Advice to safety committees
- 13.8 Accident investigation
- Annex 13.1 Checklist for safety officer's inspection
- Annex 13.2 Voluntary statement

Chapter 14 PERMIT TO WORK SYSTEMS

- 14.1 Introduction
- 14.2 Permit to work systems
- 14.3 Sanction to test systems
- Annex 14.1 Permits to work
- Annex 14.1.1 Permit to work: entry into dangerous (enclosed) space
- Annex 14.1.2 Permit to work: working at height/over the side
- Annex 14.1.3 Permit to work: general
- Annex 14.2 Sanction to test: electrical high voltage (over 1000 volts)

Chapter 15 ENTERING DANGEROUS (ENCLOSED) SPACES

- 15.1 Introduction
- 15.2 Duties and responsibilities of a competent person and an authorised officer
- 15.3 Precautions before entering a dangerous space
- 15.4 Identifying potential hazards
- 15.5 Preparing and securing the space for entry
- 15.6 Testing the atmosphere of the space
- 15.7 Use of control systems
- 15.8 Safety precautions before entry
- 15.9 Procedures and arrangements during entry
- 15.10 Procedures on completion
- 15.11 Additional requirements for entry into a space where the atmosphere is suspect or known to be unsafe
- 15.12 Training, instruction and information
- 15.13 Breathing apparatus and resuscitation equipment
- 15.14 Preparation for an emergency

Chapter 16 HATCH COVERS AND ACCESS LIDS

- 16.1 Introduction
- 16.2 General
- 16.3 Mechanical hatch covers
- 16.4 Non-mechanical hatch covers
- 16.5 Non-mechanical manually handled hatch covers
- 16.6 Steel-hinged inspection/access lids
- 16.7 Access to holds/cargo/other spaces

Chapter 17 WORK AT HEIGHT

- 17.1 Introduction
- 17.2 General
- 17.3 Portable ladders
- 17.4 Cradles and stages
- 17.5 Bosun's chair
- 17.6 Working from punts
- 17.7 Scaffolding
- Annex 17.1 Emergency planning for work at height
- Annex 17.2 Requirements for ladders
- Annex 17.3 Requirements for rope access and positioning techniques
- Annex 17.4 Requirements for scaffolding

Chapter 18 PROVISION, CARE AND USE OF WORK EQUIPMENT

- 18.1 Suitability of work equipment
- 18.2 Maintenance
- 18.3 Inspection
- 18.4 Specific risks
- 18.5 Information and instructions
- 18.6 Training
- 18.7 Duty of seafarers
- 18.8 Dangerous parts of work equipment
- 18.9 Electrical equipment
- 18.10 High or very low temperatures
- 18.11 Controls for starting or making a significant change in operating conditions
- 18.12 Stop controls
- 18.13 Emergency stop controls
- 18.14 Controls
- 18.15 Control systems
- 18.16 Isolation from sources of energy
- 18.17 Stability of work equipment
- 18.18 Lighting
- 18.19 Markings
- 18.20 Warnings
- 18.21 Hand tools
- 18.22 Portable power-operated tools and equipment
- 18.23 Workshop and bench machines (fixed installations)
- 18.24 Abrasive wheels
- 18.25 Hydraulic/pneumatic/high-pressure jetting equipment
- 18.26 Hydraulic jacks
- 18.27 Carrying of seafarers on mobile work equipment
- 18.28 Overturning of fork-lift trucks

- 18.29 Use of mobile work equipment
- 18.30 Self-propelled work equipment
- 18.31 Remote-controlled self-propelled work equipment
- 18.32 Drive units and power take-off shafts
- 18.33 Ropes
- 18.34 Characteristics of man-made fibre ropes
- 18.35 Laundry equipment
- Annex 18.1 Conformity with community requirements
- Annex 18.2 Bulldog grips

Chapter 19 LIFTING PLANT AND OPERATIONS

- 19.1 Introduction
- 19.2 General requirements
- 19.3 Register of lifting appliances
- 19.4 Regular maintenance
- 19.5 Thorough examination and inspection
- 19.6 Certificates
- 19.7 Reports, records and marking of lifting equipment
- 19.8 Controls
- 19.9 Safety measures
- 19.10 Positioning and installation
- 19.11 Lifting operations
- 19.12 Safe working load
- 19.13 Use of winches and cranes
- 19.14 Use of derricks
- 19.15 Use of derricks in union purchase
- 19.16 Use of stoppers
- 19.17 Overhaul of cargo gear
- 19.18 Trucks and other vehicles/appliances
- 19.19 Defect reporting and testing: advice to competent persons
- 19.20 Personnel-lifting equipment, lifts and lift machinery
- 19.21 Maintenance and testing of lifts
- Annex 19.1 Certificates of testing and thorough examination of equipment
 - Annex 19.1.1 Certificate of test and thorough examination of lifting appliances
 - Annex 19.1.2 Certificate of test and thorough examination of derricks used in union purchase
 - Annex 19.1.3 Certificate of test and thorough examination of loose gear
 - Annex 19.1.4 Certificate of test and thorough examination of wire rope
 - Annex 19.2 Register of ships' lifting appliances and cargo-handling gear
 - Annex 19.3 Code of hand signals

Chapter 20 WORK ON MACHINERY AND POWER SYSTEMS

- 20.1 Introduction
- 20.2 General
- 20.3 Work in machinery spaces
- 20.4 Unmanned machinery spaces
- 20.5 Maintenance of machinery
- 20.6 Boilers and thermal oil heaters
- 20.7 Auxiliary machinery and equipment
- 20.8 Main engines
- 20.9 Refrigeration machinery and refrigerated compartments
- 20.10 Steering gear
- 20.11 Hydraulic and pneumatic equipment
- 20.12 Electrical equipment
- 20.13 Main switchboards
- 20.14 High-voltage systems
- 20.15 Arc-flash associated with high- and low-voltage equipment
- 20.16 Storage batteries: general
- 20.17 Storage batteries: lead acid
- 20.18 Storage batteries: alkaline
- 20.19 Work on apparatus on extension runners or on the bench
- 20.20 Servicing radio and associated electronic equipment: general
- 20.21 Additional electrical hazards from radio equipment
- 20.22 Valves and semi-conductor devices

Chapter 21 HAZARDOUS SUBSTANCES AND MIXTURES

- 21.1 General advice
- 21.2 Carcinogens and mutagens
- 21.3 Prevention or control of exposure
- 21.4 Asbestos dust
- 21.5 Use of chemical agents
- 21.6 Dry-cleaning operations
- 21.7 Safe use of pesticides
- 21.8 Biological agents
- 21.9 Solid carbon dioxide
- Annex 21.1 Classification of carcinogens and biological agents

Chapter 22 BOARDING ARRANGEMENTS

- 22.1 Introduction
- 22.2 General principles
- 22.3 Safety nets
- 22.4 Use of equipment

- 22.5 Positioning of boarding equipment
- 22.6 Portable and rope ladders
- 22.7 Maintenance of equipment for means of access
- 22.8 Special circumstances
- 22.9 Access for pilots
- 22.10 Safe rigging of pilot ladders
- 22.11 Safe access to small craft
- Annex 22.1 Standards for means of access
- Annex 22.2 Corrosion and fractures of accommodation ladders and gangways

Chapter 23 FOOD PREPARATION AND HANDLING IN THE CATERING DEPARTMENT

- 23.1 Health and hygiene
- 23.2 Slips, falls and tripping hazards
- 23.3 Galley stoves, steamboilers and deep fat fryers
- 23.4 Liquid petroleum gas appliances
- 23.5 Deep fat frying
- 23.6 Microwave ovens
- 23.7 Catering equipment
- 23.8 Knives, meat saws, choppers, etc.
- 23.9 Refrigerated rooms and store rooms

Chapter 24 HOT WORK

- 24.1 Introduction
- 24.2 General
- 24.3 Welding and gas cutting
- 24.4 Personal protective equipment
- 24.5 Pre-use equipment check
- 24.6 Electric welding equipment
- 24.7 Precautions to be taken during electric arc welding
- 24.8 Compressed gas cylinders
- 24.9 Gas welding and cutting
- 24.10 Further information
- Annex 24.1 Hot work: lighting up and shutting down procedures
- Annex 24.2 Earthing of arc-welding systems' transformer casing
- Annex 24.3 Hot work: hoses and connections/assemblies

Chapter 25 PAINTING

- 25.1 Introduction
- 25.2 Preparation and precautions
- 25.3 Application of new paint
- 25.4 Use of paint-spraying equipment

Chapter 26 ANCHORING, MOORING AND TOWING OPERATIONS

- 26.1 Introduction
- 26.2 Anchoring and weighing anchor
- 26.3 Making fast and casting off
- 26.4 Mooring to a buoy
- 26.5 Towing
- 26.6 Safe mooring of domestic passenger craft and ships' launches to quays
- Annex 26.1 Complex mooring system, illustrating the snap-back zone
- Annex 26.2 The full and safe mooring arrangement for small domestic, passenger craft and launches

Chapter 27 ROLL-ON/ROLL-OFF FERRIES

- 27.1 Introduction
- 27.2 General
- 27.3 Ventilation
- 27.4 Fire safety/prevention
- 27.5 Noise
- 27.6 Safe movement
- 27.7 Use of work equipment
- 27.8 Inspection of vehicles
- 27.9 Stowage
- 27.10 Securing of cargo
- 27.11 Dangerous goods
- 27.12 Specialised vehicles
- 27.13 Housekeeping

Chapter 28 DRY CARGO

- 28.1 Stowage of cargo
- 28.2 Dangerous goods and substances
- 28.3 Carriage of containers
- 28.4 Working cargo
- 28.5 Lighting in cargo spaces
- 28.6 General precautions for personnel
- 28.7 Moveable bulkheads in cargo holds

Chapter 29 TANKERS AND OTHER SHIPS CARRYING BULK LIQUID CARGOES

- 29.1 General
- 29.2 Oil and bulk ore/oil carriers
- 29.3 Liquefied gas carriers
- 29.4 Chemical carriers

Chapter 30 PORT TOWAGE INDUSTRY

- 30.1 General
- 30.2 Watertight integrity
- 30.3 Testing and inspection of towing equipment
- 30.4 Connecting and disconnecting the towing gear
- 30.5 Use of bridle/gog rope during towing operations
- 30.6 Seafarer safety during towing operations
- 30.7 Communications
- 30.8 Interaction
- 30.9 Escorting

Chapter 31 SHIPS SERVING OFFSHORE OIL AND GAS INSTALLATIONS

- 31.1 General information
- 31.2 Responsibilities
- 31.3 General precautions
- 31.4 Personal protective equipment
- 31.5 Communications
- 31.6 Carriage of cargo
- 31.7 Bulk cargo operations
- 31.8 Approaching installation and cargo-handling operations
- 31.9 Transfer of personnel by ship to/from installation
- 31.10 Transfer by specialist craft
- 31.11 Transfer by personnel carrier
- 31.12 Transfer of personnel by ship to installation by transfer capsule
- 31.13 Transfer by personal basket
- 31.14 Transfer of personnel by gangway
- 31.15 Further guidance
- 31.16 Anchor handling

Chapter 32 SHIPS SERVING OFFSHORE RENEWABLES INSTALLATIONS

- 32.1 General
- 32.2 Responsibility for offshore renewables personnel
- 32.3 Coordination
- 32.4 Safe means of access to installations
- 32.5 Carriage and transfer of dangerous cargoes
- 32.6 Emergency response plans
- 32.7 Other sources of information

Chapter 33 ERGONOMICS

- 33.1 General
- 33.2 Work with display screen equipment
- Annex 33.1 Ergonomics

Appendix 1 Regulations, marine notices and guidance issued by the Maritime and Coastguard Agency

Appendix 2 Other sources of information

Appendix 3 Standards and specifications referred to in this Code

Appendix 4 Acknowledgements

INDEX

ABOUT THIS CODE

General

1. This Code is published by the Maritime and Coastguard Agency (MCA) and endorsed by the National Maritime Occupational Health and Safety Committee, UK Chamber of Shipping, Nautilus International and the National Union of Rail, Maritime and Transport Workers (RMT) as best practice guidance for improving health and safety on board ship. It is intended primarily for merchant seafarers on UK-registered ships.
2. The Code is addressed to everyone on a ship regardless of rank or rating, and to those ashore responsible for safety, because the recommendations can be effective only if they are understood by all and if everyone cooperates in their implementation. Those not actually engaged in a job in hand should be aware of what is being done, so that they may avoid putting themselves at risk or causing risk to others by impeding or needlessly interfering with the conduct of their work.
3. The MCA wishes to acknowledge the support and expert contributions from many working in the shipping industry, or with health and safety expertise, and in particular the members of the industry working group for the revision of the Code:

David Appleton, Nautilus International

Mark Carden, National Union of Rail, Maritime and Transport Workers

Ian Cloke, UK Chamber of Shipping

Lee Davison, National Union of Rail, Maritime and Transport Workers

Alan Goodden, UK Chamber of Shipping (P&O Ferries)

Allan Graveson, Nautilus International

Eddie Perkins, UK Chamber of Shipping (North Star Shipping Ltd)

In addition, we are grateful to the following companies, which released staff to take part in a working group for RMT to respond to consultation on the draft Code:

Caledonian MacBrayne

GulfMark

P&O Ferries

Royal Fleet Auxiliary

Stena Line

Living on board: occupational health and safety risks

4. Occupational health and safety risks may lead to death, permanent disability, temporary disability or reduced work capability. Occupational health and safety risks may arise from work-related hazards or from the general living and working conditions on board, sometimes referred to as ambient factors.

In cases where some risks are unavoidable, appropriate control measures should be implemented to minimise exposure to hazards that may cause injury, disease or death. Harmful exposure may have short-term or long-term adverse health effects.

5. Risks inherent in the working environment must be identified and evaluated ('risk assessment'), and measures must be taken to remove or minimise those risks, to protect seafarers and others from harm, so far as is reasonably practicable.
6. These risks include, but are not limited to:
 - ambient factors, such as noise, vibration, lighting, ultra-violet light, non-ionising radiation and extreme temperatures;
 - inherent hazards, such as the vessel's structure, means of access, ergonomic hazards and hazardous materials such as asbestos;
 - hazards arising from work activities, such as work in enclosed spaces, use of equipment and machinery, working on and below deck in adverse weather, dangerous cargo and ballast operations, and exposure to biological hazards or chemicals;
 - health risks, such as fatigue and impacts on mental occupational health; and
 - the emergency and accident response.
7. In addition, there are risks from violence in the workplace, tobacco smoking, drug abuse, alcohol misuse and drug or alcohol dependence.
8. Each of these risks is covered in this Code.

The status of the Code of Safe Working Practices for Merchant Seafarers

9. In the UK, the Merchant Shipping Act 1995 allows the Secretary of State to make regulations to secure the safety of ships and those on them. Much of the Code relates to matters that are the subject of such regulations. In such cases, the Code is intended to give guidance as to how the statutory obligations should be fulfilled.
10. Many regulations lay down specific requirements for standards of safety, equipment or operations, which must be satisfied to comply with the law. Where there are no specific requirements, the MCA generally considers compliance with the Code as demonstrating that the Company, employer or seafarer did what was reasonable to comply with the regulations. Each situation will be considered and evaluated on an individual basis. The guidance must never be regarded as superseding or amending regulation, and risk assessment should always be used to ensure that all risks are addressed.

11. References to British Standards (BS) or European Norms (EN) contained in this Code are made with the understanding that 'an alternative Standard which provides, in use, equivalent levels of safety, suitability and fitness for purpose' is equally acceptable.
12. The Code provides guidance on safe working practices for many situations that commonly arise on ships, and the basic principles can be applied to many other work situations that are not specifically covered. However, it should not be considered a comprehensive guide to safety: the advice it contains should always be considered in conjunction with the findings of the Company's or employer's risk assessment, and any information, procedures or working instructions provided by the manufacturer, supplier or any other source should be followed.
13. It is a statutory requirement that seafarers are provided with the information necessary to ensure their health and safety. The MCA considers that on UK ships this means that all those with specific responsibilities for safety should have immediate access to this Code, and that it should be readily available to all seafarers on board, e.g. a copy should be kept in the mess room. It should be provided in appropriate formats (e.g. electronic and hard copy) in sufficient quantity to ensure easy access. The Code should be supplemented by safety manuals, work instructions and other guidance issued by shipping companies for their particular ships, as appropriate.
14. Non-UK ships are not subject to all UK health and safety regulations, although failure to meet international standards of safety enshrined in those regulations may result in enforcement action while the ship is in UK waters.

International Management Code for the Safe Operation of Ships and for Pollution Prevention (International Safety Management (ISM) Code)

15. All ships of 500 gross tonnage (GT) and over are required to operate a safety management system in compliance with the ISM Code. The ISM Code provides for safety management on board the ships to which it applies. The safety management system may not in itself cover all aspects of seafarer safety and health as required by the Maritime Labour Convention 2006 (MLC 2006), e.g. with respect to disease prevention. However, a shipowner may develop that system to do so. Duplication should be avoided.
16. Compliance with the ISM Code complements existing health and safety regulations and use of the guidance in this Code. For example:
 - The ISM Code requires that the Company's safety management system should 'ensure that applicable codes, guidelines and standards recommended by the ... Administration' are taken into account. This Code is one such 'applicable code', and an ISM audit may consider how the guidance it contains has been implemented.

- The ISM Code requires that the 'safety management objectives of the Company should, inter alia, ... establish safeguards against all identified risks ...'. This Code will assist the Company in identifying risks and establishing safe practices to safeguard against them.
- The ISM Code requires the Company to 'define and document the responsibility, authority and interrelation of all personnel who manage, perform and verify work relating to and affecting safety and pollution prevention'. This Code gives advice on the roles of those with particular safety responsibilities, and highlights work areas where specific responsibilities should be allocated to a competent person.

Merchant Shipping and Fishing Vessels (Health and Safety at Work) Regulations

Duties of shipowners

*S.I. 1997/2962,
Reg. 5*

17. It is the duty of shipowners and employers to protect the health and safety of seafarers and others so far as is reasonably practicable. The principles that should underpin health and safety measures are:
 - the avoidance of risks, which among other things includes the combating of risks at source and the replacement of dangerous practices, substances or equipment by non-dangerous or less dangerous practices, substances or equipment;
 - the evaluation of unavoidable risks and the taking of action to reduce them;
 - the adoption of work patterns and procedures that take account of the capacity of the individual, especially in respect of the design of the workplace and the choice of work equipment, with a view in particular to alleviating monotonous work and to reducing any consequent adverse effect on workers' health and safety;
 - the adaptation of procedures to take account of new technology and other changes in working practices, equipment, the working environment and any other factors that may affect health and safety;
 - the adoption of a coherent approach to management of the vessel or undertaking, taking account of health and safety at every level of the organisation;
 - giving collective protective measures priority over individual protective measures; and
 - the provision of appropriate and relevant information and instruction for workers.

18. The Company and other employers owe a duty of care to other workers on board who may be affected. Where passengers are also covered, this will normally be stated.
19. The Company is also responsible for ensuring that seafarers have the appropriate information, training and instruction to enable them to work safely, making arrangements for consultation with seafarers about health and safety matters, and having systems for recording and investigating safety incidents and accidents on board. Further information about each of these aspects is contained in the following chapters.
20. The master is the representative of the Company.

Duties of seafarers

21. Seafarers are required to:
 - take reasonable care for their own health and safety and that of others on board who may be affected by their acts or omissions;
 - cooperate with anyone else carrying out health and safety duties, including compliance with control measures identified during the employer's or Company's risk assessment;
 - report any identified serious hazards or deficiencies immediately to the appropriate officer or other responsible person; and
 - make proper use of plant and machinery, and treat any hazard to health or safety (such as a dangerous substance) with due caution.
22. Under the regulations, it is also an offence for any person intentionally or recklessly to interfere with or misuse anything provided in the interests of health and safety.

Terms used in this Code

23. In this Code, unless otherwise defined in the specific chapter:

'Company' is used in the sense that it is used in the ISM Code, as the person responsible for the operation of the ship. (This is often the same organisation as the 'shipowner' referred to in health and safety regulations.)

'Competent person' means someone who has sufficient training and experience or knowledge and other qualities that allow them to carry out the work in hand effectively and safely. The level of competence required will depend on the complexity of the situation and the particular work involved.

'Responsible person' means the person designated to take responsibility for a particular work activity. There may be particular competency requirements attached to that work activity.

'Seafarer' means anyone whose normal place of work is on board the ship, whether or not they are employed.

'Thorough examination' means a systematic and detailed examination of the equipment and safety-critical parts, carried out at specified intervals by a competent person, who must then complete a written report.

'Inspection': the purpose of an inspection is to identify whether work equipment can be operated, adjusted and maintained safely, with any deterioration detected and remedied before it results in a health and safety risk. The need for inspection and inspection frequencies should be determined through risk assessment. In many cases, a quick visual check before use will be sufficient. However, inspection is necessary for any equipment where significant risks to health and safety may arise from incorrect installation, reinstallation, deterioration or any other circumstances.

'Safety management system' means the safety management system for the time being in place on the ship.

Regulations, standards, documents and other sources of information referred to in the Code

24. Where chapters of the Code refer to other documents, these are referenced in the margin, and further details, including how to obtain them, are contained in the appendices:

- Appendix 1 Regulations, marine notices and guidance issued by the Maritime and Coastguard Agency
- Appendix 2 Other sources of information
- Appendix 3 Standards and specifications referred to in this Code
- Appendix 4 Acknowledgements.

Keeping the Code up to date

25. The MCA intends to issue regular updates to the Code to ensure that it remains relevant and reflects changes in standards and in working practices. Updates will be considered by the industry working group and will be subject to wider consultation before final agreement.

If you notice anything that requires updating, please notify the MCA at mlc@mcga.gov.uk

26. The Code will be produced in digital form in due course.

CHAPTER 1

MANAGING OCCUPATIONAL HEALTH AND SAFETY

1.1 Introduction

S.I. 1997/2962

Seafarers, like shore workers, have the right and expectation that they will remain safe at work.

The Company and employers have a responsibility to ensure the health, safety and welfare at work of all seafarers and other workers on board.

Seafarers have a duty to take reasonable care for the occupational health and safety of themselves and others, and to cooperate with their employer and the Company in matters of health, safety and welfare.

By creating a culture where everyone takes responsibility for a safe working environment and takes care of themselves and one another, many work-related accidents and incidents can be avoided.

1.2 What does a safe working culture look like?

Extensive research has identified certain elements that contribute greatly to maintaining a safe working culture. These can be described as:

- clearly defined expectations;
- good communications;
- clear leadership;
- good planning;
- risk awareness;
- accountability;
- good safety culture; and
- effective knowledge management.

These elements should be both put in place at a Company level within the safety management system and implemented on board the vessel by the master and crew.

It is important that the entire workforce, from the most junior crew members through to the senior managers ashore, are involved in the

development of these elements for them to be fully successful. Many of them are already present within management systems but often some are missing, which can create weaknesses in the management system.

A good approach is to conduct a gap analysis to identify those elements that are missing or weak, and amend the systems accordingly. The more developed and comprehensive the systems are, the more effective they can be.

Guidance on these elements follows, along with some examples. Although they may differ in detail between companies and vessels, the principles remain the same.

1.2.1 Clearly defined expectations

It is important that seafarers at all levels of the organisation clearly understand what is expected of them and what standards are required.

On every ship:

- The Company has overall responsibility to establish a safety management system and occupational health and safety policies and programmes, and to ensure that the master is provided with the necessary resources and facilities to operate the ship safely and in accordance with the Company's policies and procedures.
- The master has responsibility to implement the Company's policies and procedures on board the ship, and to report any deficiencies to shore-based management for rectification.
- Every person on board has a responsibility for their own occupational health and safety and that of others, including:
 - complying with instructions, safety procedures and any other measures in place for their own or others' safety;
 - reporting any defects in equipment or unsafe conditions to a responsible person; and
 - not interfering with or altering any safety device provided on board.
- All crew members should have a job description.

In addition, any seafarer should feel confident to stop work if they feel unsafe – sometimes known as 'stop work authority'.

It is important that a comprehensive and clear induction process is carried out, with respect to Company and vessel-specific requirements, for every joining member of the crew. The inductions should be used to explain the rules and expectations in a format that is easily understood. All crew members should be given copies or overviews of rules appropriate to

them, along with information on where the full information can be found. Examples of these rules may include:

- the Company handbook;
- the vessel guidebook; and
- pocket cards.

More information on inductions can be found in Chapter 2, Safety induction.

There should be clear and concise policies, procedures and safety rules contained within the safety management system and associated documentation. These should be reviewed regularly to ensure that they are appropriate, remain valid and can be communicated to the crew in various ways including:

- during the Company and vessel inductions;
- as part of the on-board and external training programmes;
- through on-board supervision and monitoring; and
- in safety committee meetings.

Seafarers need to be aware of what happens if rules are not followed. This can be achieved by using a just culture policy as described below and ensuring that all are aware of the *Code of Conduct for the Merchant Navy*.

Improvement plans with clear achievable targets and goals are useful in managing continuous and sustainable improvement. It is important that these plans are well communicated and that all seafarers are involved, both in their development and implementation. Improvement plans can be standalone or incorporated into other planning tools. They should be used to set priorities and measure progress.

1.2.2 Good communications

Effective communications and workforce involvement is crucial in ensuring a safe living and working environment. Communication is a two-way process. There is a need to be able to gain information and knowledge that can be acted upon and passed on to others who need it, and systems need to be in place to facilitate this at all levels in the organisation. Some examples include:

- ensuring everyone understands their roles and responsibilities;
- ensuring orders and instructions are properly understood, acknowledged and acted upon;
- passing safety-critical information between watchkeepers and changing crews;

- ensuring information posters, signs and instructions are clear and can be understood;
- ensuring safety alerts, memos and newsletters are clear and can be understood;
- encouraging feedback, improvement suggestions and safety observations, and acting on the information received;
- safety meetings should be minuted and the reports distributed and acted upon where appropriate; and
- ensuring a good, clear and reliable system of emergency response communications is in place.

Formal arrangements for consultation and communication (through the safety committee) are described in Chapter 13, Safety officials. However, communication should extend beyond those with a formal role under those arrangements.

There should be a clear and simple system for reporting problems and suggesting solutions. This would typically use an improvement suggestion system and a proactive reporting system for unsafe acts and conditions. These are at their most effective when developed in consultation with the workforce.

Clear, unambiguous language should be used at all times. Jargon and acronyms should be avoided unless everyone understands what they mean. Whilst it may be reasonable to believe that all seafarers understand common nautical terminology, it is not reasonable to expect them to understand terms found in local slang or dialects. The designated working language of the vessel should be used. On ships with multicultural crews, particular care should also be taken to avoid misunderstanding as a result of different body language or cultural norms.

Face-to-face communications should be actively encouraged and techniques to confirm understanding should be used. This can be particularly effective during visits by senior and line management, and can give a very strong indication of how the Company's values and safety procedures are being implemented.

Change should be discussed and input from all should be actively sought. Clear information regarding the reasons and need for the change should be given and discussed. Prompt feedback should be given on any issues raised, both positive and negative. This will ensure that all concerned are part of the process and help them to be fully engaged and committed to any necessary changes.

There should be an open-door policy that encourages and enables people to discuss any concerns and issues that they may have. Consideration and feedback should be given on issues and concerns raised.

Company magazines, newsletters and regular sharing of learning bulletins are all good additions to safety alerts and other official communications in getting the safety message across in an accessible and understandable manner, ensuring that credit is attributed to any contributing seafarers.

1.2.3 Clear leadership

Research both in the maritime and other hazardous industries confirms the huge impact of leadership on the safety of operations. The effectiveness of the International Safety Management (ISM) Code depends heavily on how leaders approach its implementation, and this in turn depends heavily on the skills and qualities of leaders – both at sea, at the ship–shore interface, and on shore.

Despite best endeavours to work safely, sometimes real life makes things difficult – time pressures, economic constraints and everyday circumstances sometimes seem to conspire against good safety leadership. What really counts is how leaders behave in everyday situations. Seafarers will draw inferences about safety leadership based on what they see their leaders do and what they hear them say, far more than what they hear in formal spoken or written communication.

There are many models of leadership, and some companies will run their own leadership programmes. The following advice is taken from the Maritime and Coastguard Agency publication, *Leading for Safety: A practical guide for leaders in the maritime industry*.

The ten core safety leadership qualities

1. Instil respect and command authority

The ability to instil respect from, and command authority over, seafarers is probably the first thing that comes to mind when people think of leadership. In many ways, it happens on its own when everything else is right. Leaders get respect and command authority when crews believe that they:

- are willing to exercise the power vested in their position;
- possess the necessary knowledge and competence;
- understand their situation and care about their welfare;
- are able to communicate clearly;
- are prepared to act confidently and decisively; and
- listen.

2. Lead the team by example

Leading the team by example is the combination of two things: being seen to be complying with the safety procedures, and working as a key part of the team, including being willing, where necessary, to get involved in subordinates' tasks.

3. Draw on knowledge and experience

Adequate knowledge and experience are prerequisites for effective leadership. In the context of safety leadership, this means in particular:

- good knowledge of safety-related regulations, codes and standards; and
- experience and skills not only in technical and operational issues but also in people management.

4. Remain calm in a crisis

People need strong, clear leadership in a crisis and rely more on their leaders than would otherwise be the case. Calmness in a crisis situation is a core requirement and will rely on many of the other leadership qualities described, including commanding authority and drawing on knowledge and experience. In particular, it is important to have confidence and trust in the crew's abilities and emergency preparedness. Attendance at safety training and at response drilling is essential for all seafarers.

5. Practise 'tough empathy'

Empathy is all about identification with and understanding of another's situation, feelings and motives. It requires the capacity to put oneself in another's place, and the cultivation of good listening skills. Good leaders empathise realistically with seafarers and care intensely about the work they do – but this doesn't mean that they always agree with them or join in with concerns and grumbles. Instead they practise 'tough empathy', which means giving people what they **need**, rather than necessarily what they **want**. Another way of looking at this is 'care with detachment'. An example is providing staff with safety footwear that is comfortable and safe, rather than spending more money to provide a more fashionable style.

6. Be sensitive to different cultures

Crews of mixed nationalities are the norm. Good leaders are sensitive to differences in the social and behavioural norms of national cultures, yet at the same time value all seafarers equally irrespective of their nationality. They know how to interpret different behavioural signals, and how best to react in order to exert the strongest influence.

7. Recognise seafarers' limitations

Good leaders have a clear understanding of how operational and other demands can be realistically met by seafarers, and are able to judge whether fatigue levels are such that action should be taken.

8. Motivate a sense of community

Research has shown that people in work are typically motivated by satisfaction or pride in completing a good job, and the feeling of being part of a team – not just by money. Leaders have an important role to play in creating the conditions to encourage and maintain these ‘healthy’ motivators. Demonstrating respect for staff is often an essential part of this. Meeting someone’s basic needs is often the key to keeping their motivation high.

9. Place the safety of crew and passengers above everything

It is universally accepted that commitment from the leader is an absolute essential for good safety. Leaders need to demonstrate this commitment clearly to their staff through their actions, rather than just through formal declarations or policy statements. In practice, this means showing that the safety of the crew and passengers is placed above everything else – ‘nothing we do is worth getting hurt for’.

10. Communicate clearly

The ability to communicate clearly is important at all levels in an organisation. For a master, the key issue is most often how to encourage better two-way rather than one-way communication, balancing authority and approachability. Being open to criticism is a part of this.

1.2.4 Good planning

Good planning is essential in ensuring occupational health and safety at work. Adequate control of risks can only be achieved by ensuring that all involved are aware, activities are coordinated and good communication is maintained by all.

You should carefully consider what you want to achieve, what actions are necessary, how these will be carried out and what effect they may have on seafarers’ health and safety at work, taking into account that there may be consequences that are indirect and unintended.

Consideration should include:

- what might cause harm to people and whether enough is being done or needs to be done to prevent that harm;
- how improvements will be prioritised;
- who will be responsible for occupational health and safety tasks, what they should do, when and with what results; and
- how achievements will be measured against objectives and reviewed.

The planning process should include participation for those involved and consideration for those who may be affected. Clear instructions for required activities should be issued and adequate time and resources should be provided. Confirm that all fully understand the instructions

(known as closed-loop communication). Permit to work systems should be used where appropriate (see Chapter 14, Permit to work systems) and learning captured and applied to future work.

Management of change

The majority of effective change management on board is adequately controlled through the use of pre-existing processes such as handover procedures, safe systems of work and sound navigational practices. However, some changes introduce new factors that may not be covered by existing controls. These could include, for example, unexpected changes to personnel, fatigue, inclement weather, a change to the operation whilst under way or more complex changes, i.e. fitting new equipment or a change in operations.

Changes can become necessary for a variety of reasons. It is important that these changes are effectively managed in order to ensure that:

- they are necessary;
- they are realistic and achievable;
- they are planned and systematically managed;
- any impact on operations, both negative and positive, is understood and managed;
- they are effectively communicated;
- they are effectively implemented; and
- those affected are consulted.

The appropriate level of change management required will vary according to circumstances. Some companies have formal procedures in place that define the level of change management necessary. Annex 1.1 gives an example of such a procedure.

1.2.5 Risk awareness and risk assessment

Risk awareness

If seafarers are fully informed and aware of the risks to their health, safety and welfare, they are much more likely to ensure they avoid the risks and remain safe. This knowledge is attained through risk assessment and in other ways throughout our lives including training in theory and practical application, information, observation, instructions, supervision and personal experience. We can improve the quality and usefulness of the information available by effective knowledge management, which is covered in section 1.2.8.

Key terms

A **hazard** is a source of potential injury, harm or damage. It may come from many sources, e.g. situations, the environment or a human element.

Risk has two elements:

- The likelihood that harm or damage may occur.
- The potential severity of the harm or damage.

A key tool in ensuring that all involved in the work have a clear understanding and awareness of any hazards and their associated risks is the carrying out of a toolbox talk before the work commences.

Application of the knowledge in the workplace is influenced by our values, beliefs, attitudes and behaviours and by the views of others. This is facilitated by ensuring a safe working culture (see section 1.2.7).

Risk assessment

The risk assessment process identifies hazards present in a work undertaking, analyses the level of risk, considers those in danger and evaluates whether hazards are adequately controlled, taking into account any measures already in place.

Effective risk assessments:

- correctly and accurately identify **all** hazards;
- identify who may be harmed and how;
- determine the likelihood of harm arising;
- quantify the severity of the harm;
- identify and disregard inconsequential risks;
- record the significant findings;
- provide the basis for implementing or improving control measures; and
- provide a basis for regular review and updating.

Potential language difficulties should be taken into account. Temporary staff or those new to the ship or the Company who are not fully familiar with the safety management system or other operational details should be considered where relevant. Other seafarers who should be given special consideration include young persons and pregnant seafarers.

Any risk assessment must address risks to the occupational health and safety of seafarers. Advice on assessment in relation to using personal protective equipment, manual-handling operations and using work equipment is given in Chapters 8, 10 and 18. In addition, specific areas

*MGN 1838(M)
and MGN
522(M+F)*

of work involving significant risk, and recommended measures to address that risk, are covered in more detail in later chapters of the Code.

The assessment of risks must be 'suitable and sufficient' but the process need not be overcomplicated. This means that the amount of effort that is put into an assessment should depend on the level of risks identified and whether those risks are already controlled by satisfactory precautions or procedures to ensure that they are as low as reasonably practicable. The assessment is not expected to cover risks that are not reasonably foreseeable.

Regs 7(1) and (6)

There are no fixed rules about how risk assessment should be undertaken. The assessment will depend on the type of ship, the nature of the operation, and the type and extent of the hazards and risks. The intention is that the process should be simple, but meaningful. The relevant legislation regarding risk assessments should be referred to when deciding on what methodology will be employed. There is a requirement that seafarers must be informed of any significant findings of the assessment and measures for their protection, and of any subsequent revisions made. It is therefore advisable that copies are carried on board each vessel and that there is a process for regular revisions to be carried out. In particular, the risk assessment must be reviewed and updated as necessary, to ensure that it reflects any significant changes of equipment or procedure or the particular circumstances at the time, e.g. the weather or level of expertise of those carrying out the task.

Risk assessment should be seen as a continuous process. In practice, the risks in the workplace should be assessed before work begins on any task for which no valid risk assessment exists.

A simple guide for small businesses can be found in Annex 1.2.

A very effective approach that is employed by some companies is to use a four-level process, as outlined below.

Risk assessment level 1

The ISM Code requires that the safety management objectives of the Company should, amongst other things, assess the risks associated with all identified hazards in respect of its ships, personnel and the environment, and establish appropriate safeguards.

These risk assessments, sometimes known as generic risk assessments, should therefore be carried out at a high level in the Company with appropriately knowledgeable and experienced personnel, and the results used to ensure that appropriate safeguards and control measures are contained within the Company's safety management system in the form of policies, procedures and work instructions.

Risk assessment level 2: task based

In addition to the general requirements under the ISM Code, the Merchant Shipping and Fishing Vessels (Health and Safety at Work) Regulations 1997 require that a suitable and sufficient assessment shall be made of the risks to the occupational health and safety of seafarers arising in the normal course of their activities or duties.

There are vessel- and task-specific risk assessments that must be carried out on board each vessel. Whilst it is clear that the Company can assess the generic risk of, for example, working at height, working with electricity, movement about ship, etc., it is not possible for them to conduct a risk assessment for changing a navigation light bulb up the main mast on a given vessel on a given day because they would not be able to take into account all the factors that were applicable at that time on that vessel. For this reason, it is essential that any generic risk assessments are used in context, and not seen as being suitable for specific tasks. For this, task-based risk assessments (TBRAs) should be carried out on board each vessel by those involved in the work.

Two distinct types of TBRA may be used. First, a range of vessel-specific generic TBRAs that can be used for all routine and low-risk tasks can be developed. These should be periodically reviewed, but frequency would very much depend on the particular circumstances on the vessel and the level of risk.

The second type of TBRA would be used for specific high-risk jobs that are not routine, such as working aloft or enclosed space entry. These should relate to the specific persons who will be involved in the work and valid only for the duration of that job.

In both cases, the assessments should be carried out by a competent person or persons who understand the work being assessed. It is also preferable that seafarers who will be involved in the work should also be involved in the assessment process.

Risk assessment level 3: toolbox talk

A toolbox talk is another form of risk assessment carried out in support of a TBRA. Its prime purpose is to talk through the procedures of the job in hand and the findings of the TBRA with the seafarers involved.

When carrying out a toolbox talk, it is important to actively involve those carrying out the work and others who may be at risk, i.e. seafarers, sub-contractors and others on board ship who may be affected by the work. Full and active participation should be encouraged and any questions or concerns discussed and taken into consideration. Once finished, confirm that all fully understand their role in the task and the precautions in place

('closed-loop communication'). This should then be recorded along with details of any relevant risk assessment referred to.

A toolbox talk should be conducted prior to any work being carried out that involves more than one person and where there is significant risk to persons or assets.

Risk assessment stage 4: personal assessment of risk

This is an informal assessment of day-to-day risks carried out as you are going about your work and life in general. It is a technique used to ensure that we perform even the most mundane of tasks without getting hurt. It is used to maintain awareness of our environment at all times and aid in the identification and control of immediate hazards as we go about our work. Use of personal assessment of risk should be developed and encouraged.

This is about taking a few minutes to step back, look at the job to be done, consider what could go wrong and how it may occur, and what steps you can personally take to avoid any incident occurring. As the work is proceeding, you should also monitor the worksite for any change in conditions that might alter the hazards and controls in place. If there is any concern, stop the work, re-assess the controls and, if necessary, re-plan and re-assess the task.

This approach may also be called a 'dynamic risk assessment'. If the person does not believe that the dynamic risk assessment is sufficient move back to stage 2.

Every task carried out on board the vessel should be subject to risk assessment. This does not mean that a risk assessment needs to be written every time a simple task is carried out, but the existing risk assessment must be referred to as part of a toolbox talk (stage 3) before the task can commence to ensure that the hazards and controls are fully understood, still relevant and appropriate.

Once the task commences, it is important to monitor the work site for any changes in conditions that might alter the hazards and controls in place. If there is any concern, stop work authority should be used.

In all cases, on completion of the task, it is important to record or feedback any lessons learned and make improvements for next time including, where appropriate, reviewing and updating existing risk assessments. Everyone should be encouraged to contribute.

It is recommended that a proactive hazard-reporting system with empowerment and expectation for immediate corrective action is also in place and that information on hazards and risks is shared as widely as possible.

1.2.6 Accountability

Maintaining a safe living and working environment on a vessel is a shared responsibility of all on board and ashore. All personnel have a role to play and they can adversely affect others on board by their acts and/or omissions. For these reasons, it is important that:

- there are well-defined rules and guidelines, which are clearly understood;
- responsibilities are clearly defined for all on board and ashore;
- consequences of unacceptable (safety) behaviour are made clear; and
- there is a fair, transparent and consistent response to unacceptable safety behaviour, commonly referred to as a 'just culture'.

Points 1 and 2 have been covered under 'Clearly defined expectations' (section 1.2.1) and 'Good communications' (section 1.2.2) above.

Just culture

A just culture policy is an important part of a positive health and safety culture. It clearly sets out the expectations for adherence to procedures in the workplace and provides a context for enforcing them. It recognises behaviours that exceed Company expectations as well as those that fall below expectation, but are not always the fault of the seafarer.

A just culture places responsibilities on management to provide support, training and resources such that seafarers will have the necessary competence to undertake their tasks to the required standard.

The just culture policy provides a process (with appropriate support) for managing behaviours that fall below expectations in a transparent and fair manner. A just culture seeks to improve the organisational culture and the performance of the organisation by modifying behaviour, encouraging seafarers to take greater personal responsibility for their actions and rewarding behaviour exceeding expectations. It also recognises that firm action may be needed in circumstances where, despite management having carried out their responsibilities, inappropriate behaviours are still evident.

The just culture decision tree is a guide for ensuring consistent management for those who exceed or deviate from Company standards. The model presents a simple, yet robust, means of dealing with both exemplary and inappropriate behaviours, linked with a structure for an appropriate management response. It also recognises that there are overlaps between the areas of any given established disciplinary response. It is essential that managers or supervisors fully understand the causal factors and root causes of an event before applying the decision tree.

Where incorrect causes have been identified and applied to the model, there is a danger that inappropriate action is taken.

The decision tree operates on an increasing personal accountability baseline:

- On the proactive side, the baseline covers a range from expected behaviour to exemplary behaviour.
- On the reactive side, the baseline covers a range from initiating actions that were malevolent, reckless, etc. (at the most extreme end) through to a no-blame error.

The decision tree is linked to a Company action model:

- On the proactive side, Company actions range from actions for management to encourage behaviour through to rewarding seafarers for their exemplary work.
- On the reactive side, Company actions range from dismissal (at the most extreme response end) to coaching/mentoring (at the least extreme response end).

This recognises that both seafarer and Company have responsibilities for achieving improvements in behaviour and increasing the Company's safety culture.

Substitution test

The substitution test asks a reasonable person: 'Given the circumstances that existed at the time of the event, could you be sure that you would not have committed the same, or similar, breach of procedures, standards, unsafe act, etc.?' This should be conducted by several people independently and reviewed by all involved to gain agreement and consensus.

Management of supervisory interventions

Management or supervisory interventions following breaches of procedures/codes of practice/standards or any formalised Company/vessel rules can be an effective and powerful way of modifying individual behaviour.

However, it is essential that the type of management response is appropriate. The just culture provides a framework to guide management in identifying an appropriate and common response. The decision tree should be used as a guide to ensure consistent handling of deviations from acceptable standards of behaviour.

Just culture decision tree

Behaviour that meets or exceeds expectations

Growing personal responsibility

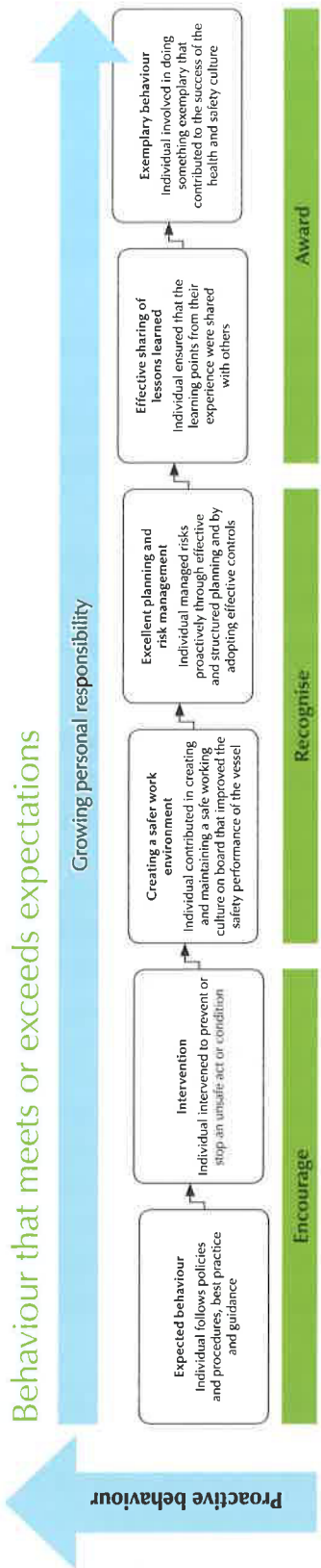

Behaviour that falls below expectations

Reactive behaviour

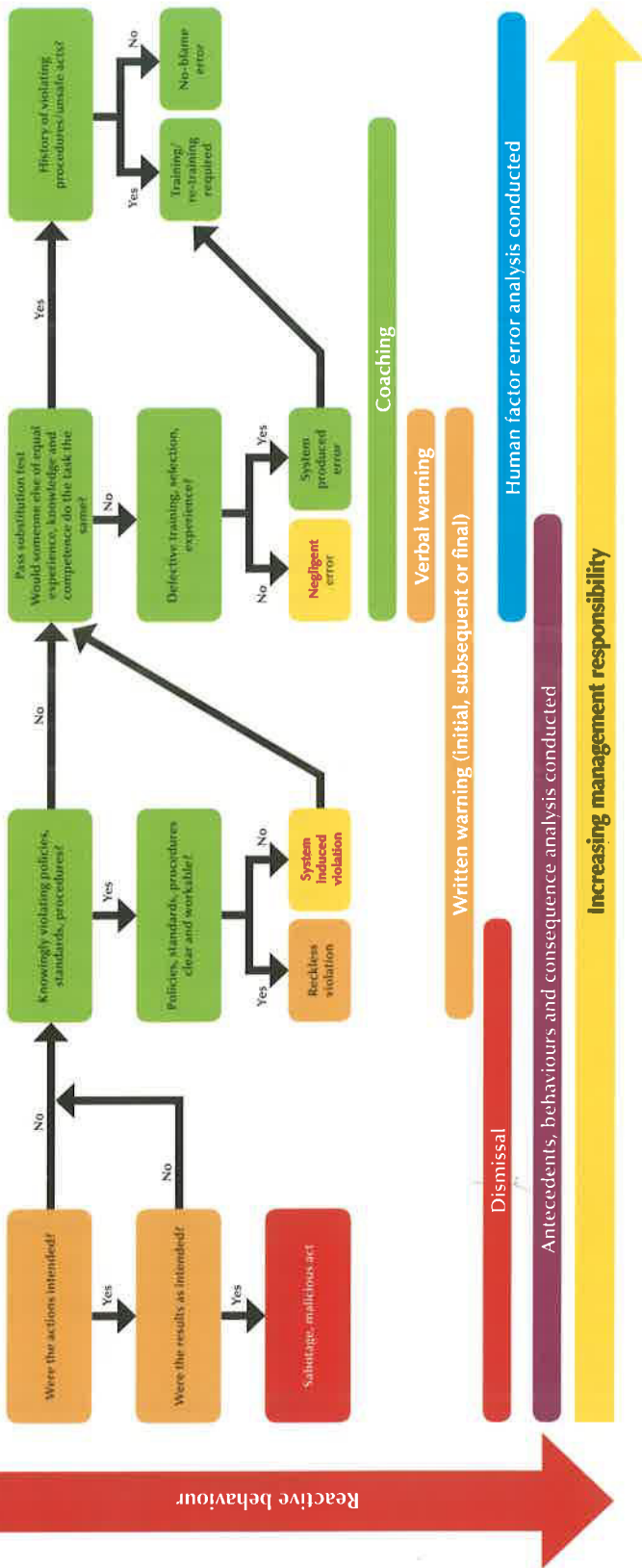

1.2.7 Good safety culture

A good safety culture is one where safety is an integral part of everything that is planned, discussed, done and documented. With a good safety culture, everyone in the Company thinks about safety and new ways of improving it as a matter of course. They are constantly on the lookout for any unsafe acts or unsafe conditions, look out for each other, intervene to prevent accidents and incidents, actively share good ideas and always seek to improve.

In order to achieve a good safety culture, there are certain key components that need to be encouraged. This begins with ensuring that all seafarers fully understand their roles and responsibilities; not just what they have to do, but also why it is important. They need to be informed and share their knowledge to help inform others.

All personnel, at every level of the Company, need to be fully engaged and committed to nurturing and developing the safety culture. Compliance with safety rules should be established as a core Company requirement and good safety behaviours should be the norm.

Another key aspect to developing a good safety culture is the concept of continual improvement: the Company should be a learning organisation. This should be a personal commitment and responsibility of everyone in the Company. There need to be systems and infrastructure in place to facilitate this process. A proactive reporting system for unsafe acts and conditions, and improvement suggestions, should be in place, and all accidents and incidents should be investigated and findings widely disseminated. See section 1.2.8 on effective knowledge management for further information.

There needs to be an open and just culture that recognises that it is normal for human beings to make mistakes. It also needs to recognise that there are wider organisational factors that affect our behaviours and can create barriers to safe behaviours. It is vital that all are empowered and feel comfortable in reporting unsafe acts, unsafe conditions, accidents and incidents without fear of unjust reprisals. This is critical in a robust safety culture.

None of this should be radically different from what is being done now and often most of the component parts are in place in some form or another. However, for any culture to be truly safe, all the elements discussed in this chapter should be fully developed.

The National Maritime Occupational Health and Safety Committee has published guidance in *Guidelines to Shipping Companies on Behavioural Safety Systems*.

1.2.8 Effective knowledge management

From an occupational health and safety perspective, efficient management of knowledge can significantly improve learning and understanding and prevent accidents and incidents from being repeated. This is particularly useful in our industry where similar high-risk activities are being carried out on numerous autonomous units, such as a fleet of ships.

It has been said: 'Man learns from his mistakes, but a wise man learns from the mistakes of others.' By effectively collecting relevant information, organising it so it can be understood and distributing it to those who can use it, we can share experiences and increase our knowledge. Applying this knowledge to our own working environment will allow us to reduce the likelihood of the same type of accident or incident reoccurring on our vessel.

Knowledge management is about:

- getting the right information;
 - understand what information and knowledge has value, can improve safety, operations or services, or is necessary for fast and effective decision making;
- making it easy to understand;
 - convert the information into a format that can be easily understood and acted upon at all levels in the Company;
- getting it to the people who need it, when they need it;
 - create the necessary technical and cultural 'delivery systems' and organise information and knowledge so it is useful and available;
- encouraging them to use it;
 - develop an organisational structure and culture that encourages seafarers to take what they know, apply it effectively for both continuous improvement and innovation, and share it with others.

Knowledge management does not have to be complicated or difficult. Most companies will have many of the elements in place already; it is often just a case of ensuring that they are all working together.

Getting the right information

Information is gathered from data retrieved, both internally and externally. Accident and incident investigations, Marine Accident Investigation Branch reports, safety alerts, audits and inspections, maintenance records, trip reports, safety meeting reports, masters' reviews, vessel visits, safety observations and improvement suggestions are but a few of the sources. It is likely that some form of analysis of the data will be needed. This

can be achieved in several ways including the use of spreadsheets to create statistics. It is important to ensure that all personnel at all levels are involved in gathering this information.

Making it easy to understand

Different approaches may be needed for different levels of the organisation. For example, statistics presented as a spreadsheet may be appropriate for senior management but safety alerts, amendments to procedures, bulletins and learning points memos may be more effective in introducing any lessons from the accidents and incidents depicted in the statistics. It is important that the data received are converted into useful information that makes sense to the end user. It is helpful to ask for feedback from the end user on the usefulness of the information.

Getting it to those who need it, when they need it

This information must be presented so that it can be understood and is clear, useful and available to the end user. There are many ways that this can be done: posters, memos, video, computer-based training, amendments to the safety management system and safety alerts are some examples. The choice of the best medium to transmit the information will vary in each Company. Often a Company newsletter can be a very effective means of getting the information out to the fleet in an easy-to-understand way.

Encouraging them to use it

No amount of shared knowledge will be useful unless those receiving it are empowered and feel comfortable using it. An open and honest safety culture that encourages all seafarers to share the same high values and beliefs in healthy and safe working is essential. All should be encouraged to use the knowledge and to gather useful information to share.

It is important to understand the difference between data, information and knowledge:

Data: 16JULBA3292ABZ0850ALCY1020A

Information: On 16 July, British Airways Flight 3292 leaves Aberdeen at 8.50 am and arrives at London City Airport at 10.20 am.

Knowledge: British Airways runs pretty much on time but airport construction is currently taking place. At that time of the morning, traffic in Aberdeen can add an hour to your journey from the south and there will be long queues at security due to the volume of passengers. If you want to catch the 8.50 am flight, give yourself an extra 90 minutes to get there.

In real terms, therefore, the basis of good knowledge management lies in having effective systems to gather, process, distribute, learn and review throughout the Company and industry to improve understanding of those things that can cause us harm and lead to accidents and incidents, and to encourage all to be fully engaged in the process.

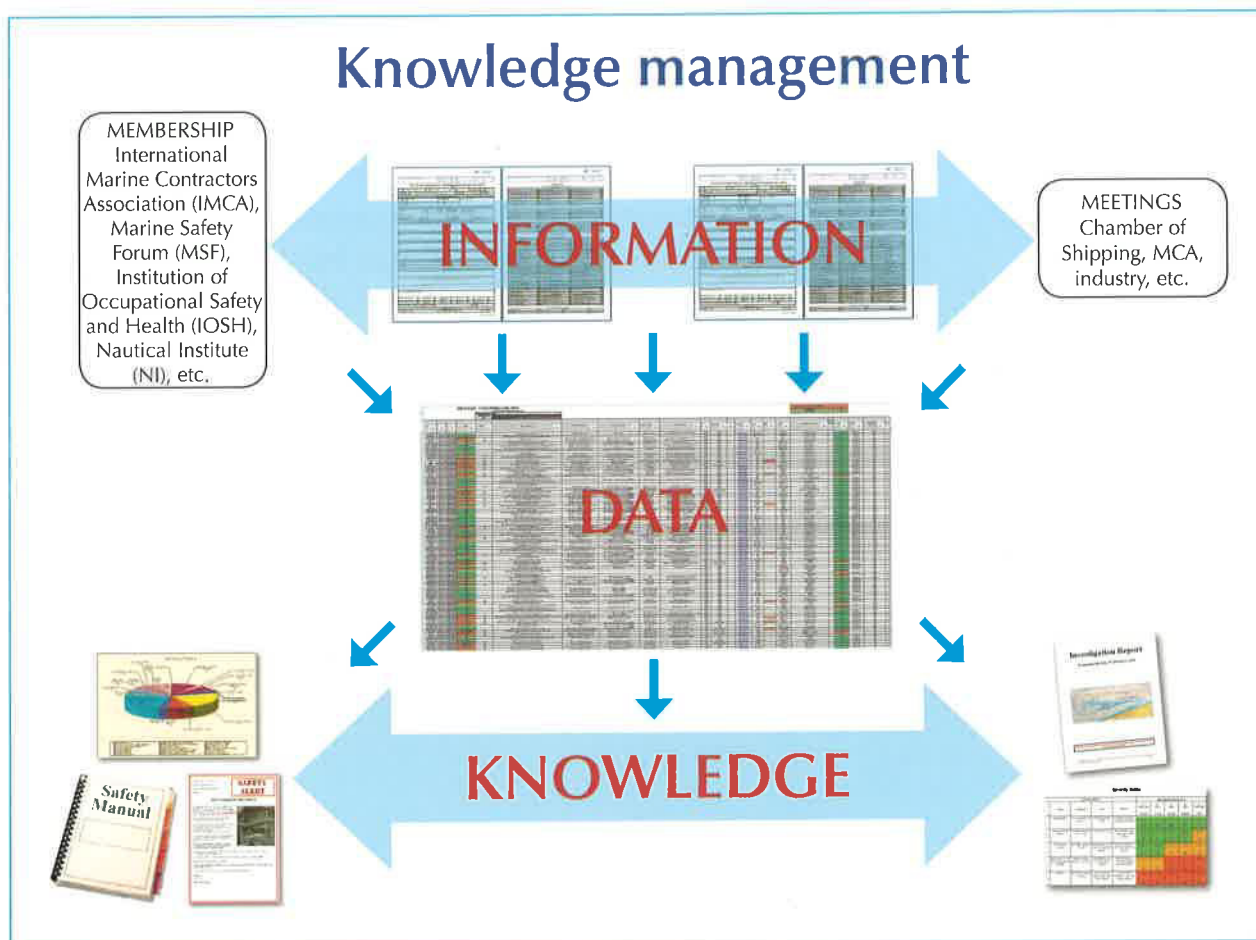

Incident investigation

MGN 484(M)

Effective incident investigation is a key component of a good knowledge management system. In the best systems, this would include all accidents, near misses, unsafe acts, unsafe conditions and non-conformities.

The ISM Code requires that a safety management system includes procedures for reporting, investigating and analysing every non-conformity, accident and hazardous situation, in order to improve safety and pollution prevention. This should then lead to the implementation of corrective actions.

The safety officer will often undertake this work and guidance is provided in Chapter 13, Safety officials. However, on ships with no safety officer, the Company must make other arrangements to ensure that this function is carried out. Any accident or incident should be recorded so that it can

be investigated to find out what went wrong and to see if anything can be done to prevent it happening again.

Every seafarer has a responsibility to:

- report deficiencies, conditions that are causing concern and things that could be improved so that those with specific safety responsibilities can put things right; and
- contribute views on how things could be made safer.

Lessons can also be learned from accidents and incidents on other ships and even in other sectors. Some industry organisations publish accident statistics and safety information and these may help to identify likely risks and suitable safety measures. Information can be found in marine guidance note MGN 484(M).

Annex 1.1 Management of change

Sample procedure covering simple and complex change

Simple change

The following steps are those envisaged as being necessary to effect a simple change.

It is important to recognise that the following procedure is for task-based changes only, not for routine tasks, unless deemed so by the ship's master or superintendent operations personnel, or it involves a complex change.

If a simple, task-based, change develops or is recognised whilst a task is under way (e.g. inclement weather, reduced time to carry out the task, unexpected changes to personnel, operational changes), in all cases, **stop the job**. In order to manage the simple change, the toolbox talk for the task should be re-visited by all involved, and any required alterations to working practices or control measures should be instigated and recorded.

This will ensure that the risk is reduced to a level that is as low as reasonably practicable. If this is not achievable, then **stop the job** until such time as an acceptable level of risk can be attained. If the risk is within levels deemed acceptable, then the task may proceed.

If the task involved is being carried out under a permit to work, the permit controller should be notified as soon as possible, and the permit suspended until the change is assessed.

Once assessed and recorded, the permit (where applicable) may be reinstated and the task can be restarted.

In order to effect change, it is important that the risk assessment is re-visited, and any changes identified through the management of change process added to the risk assessment for future use and consideration.

Complex change

The following steps are those envisaged as being necessary to effect a complex change:

1. A perceived change is identified through:
 - an improvement suggestion form;
 - the safety officer's recommendation;
 - the master's/chief engineer's management review;
 - the manager's review; or
 - internal or external audit findings.

2. Ownership of the change should be clearly identified. The Company should allocate a responsible manager or superintendent (responsible person) to investigate the change for applicability, suitability and practicability. Any cause for concern related to the change should be brought to the attention of the responsible person. The ownership of the change should be allocated to the most appropriate available manager/superintendent for the task at the discretion of the Company.
3. The responsible person should begin documenting the change using the management of change form.
4. The responsible person should then evaluate the cost versus the benefits, assessing the impact of the change on seafarers, processes, materials and plans. The results of this process should be reported to the appropriate Company for a decision.
5. If approved, a plan and risk assessment for the change should be completed. The responsible person, in consultation with all involved, should assess if there are any factors that would render the task unsafe. If there are, then risk reduction measures should be put in place to lower any risk to as low as reasonably practicable. If this is not achievable, then **stop the job** until such time as an acceptable level of risk can be attained and the job resumed, or permanently stopped.
6. Where the change is a temporary or interim measure:
 - Seafarers having recently joined the vessel should be made aware of the change(s) during their induction and continual training/assessment.
 - Any locally produced procedures are to be printed, signed by the master and/or chief engineer, laminated and prominently displayed. Should the change involve machinery use, the procedure should be displayed prominently at or in the near vicinity of the machinery, and any corresponding risk assessments updated.
7. If any procedures in the safety management system require amendment, the designated person ashore/responsible person should be notified immediately in order that the change can be facilitated.
8. All people associated with the change shall verify that they are aware and have understood it. This is to be recorded on the management of change form, and it is the duty of the responsible person to ensure that it is completed.

9. The management of change form should then be submitted to the responsible person or a member of that department in their absence, to verify all steps have been followed and sufficiently recorded prior to the task being started.
10. The responsible person, or member of that department, should, where necessary, ensure that the change process is concluded once the task is completed, or reviewed at a defined period within the change plan, if the change is a long-term change. This process or review should also include a review of the associated risk assessment, including making any amendments identified and communicating these changes to those concerned.
11. Once the change has been carried out, and all temporary modifications have been removed, the responsible person should sign the management of change form to conclude the process.

Simple change

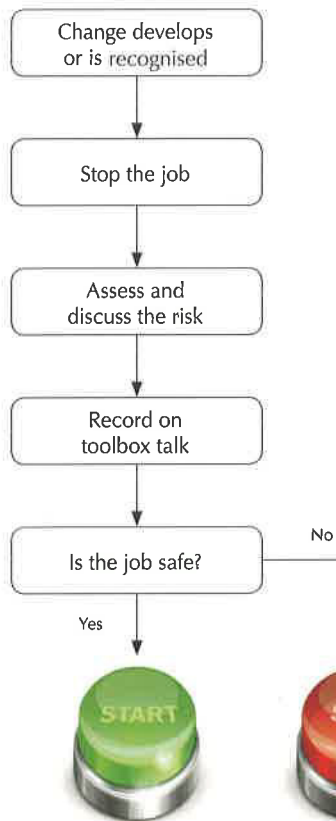

Complex change

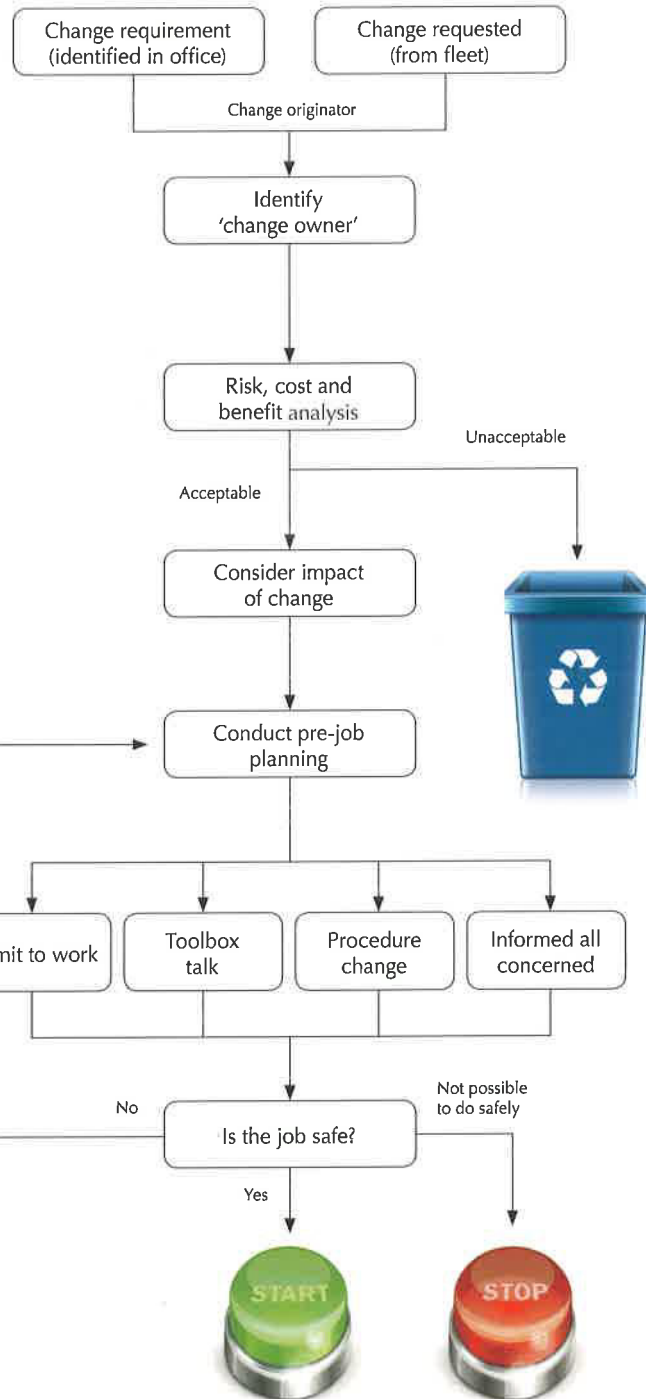

Annex 1.2 Five steps to risk assessment

MGN 20(M+F)

Based on www.hse.gov.uk. Alternative text can be found in MGN 20(M+F).

Step 1: identify the hazards

First, you need to work out how people could be harmed. When you work in a place every day, it is easy to overlook hazards, so here are some tips to help you identify those that matter:

- Walk around your workplace and look at what could reasonably be expected to cause harm.
- Ask your employees or their representatives what they think. They may have noticed things that are not immediately obvious to you.
- Consider published information on accidents and near misses on ships, which will highlight common hazards and high-risk activities.
- If you are a member of a trade association or protection and indemnity insurance (P&I) club, contact them. Many produce very helpful guidance.
- Check manufacturers' instructions or data sheets for chemicals and equipment because they can be very helpful in spelling out the hazards and putting them in their true perspective.
- Have a look back at your accident and ill-health records – these often help to identify less obvious hazards.
- Remember to think about long-term hazards to health (e.g. high levels of noise or exposure to harmful substances) as well as safety hazards.
- Consider people who may be particularly vulnerable (e.g. young persons or pregnant seafarers).

MGN 484(M)

Step 2: decide who might be harmed and how

For each hazard, you need to be clear about who might be harmed, because this will help you to identify the best way of managing the risk. That doesn't mean listing everyone by name, but rather identifying groups of people (e.g. 'people working in the storeroom' or 'passers-by').

Remember:

- Some seafarers require particular consideration: new and young seafarers, those for whom the working language of the ship is not their first language, or those new to the ship who may not be familiar with Company or ship safety procedures may be at particular risk. Extra thought will be needed for some hazards.
- Stevedores, contractors and surveyors may not be in the workplace all the time.

- Members of the public could be hurt by your activities.
- If you share your workplace, you will need to think about how your work affects others present, as well as how their work affects your staff – talk to them.
- Ask your crew if they can think of anyone you may have missed.

In each case, identify how they might be harmed, i.e. what type of injury or ill health might occur. For example, crew on roll-on/roll-off ferry car decks may be at risk from excess fumes.

Step 3: evaluate the risks and decide on precautions

Having spotted the hazards, you then have to decide what to do about them. The law requires you to do everything 'reasonably practicable' to protect people from harm. You can work this out for yourself, but the easiest way is to compare what you are doing with good practice.

First, look at what you're already doing; think about what controls you have in place and how the work is organised. Then compare this with the good practice and see if there's more you should be doing to bring yourself up to standard. In asking yourself this, consider:

- Can I get rid of the hazard altogether?
- If not, how can I control the risks so that harm is unlikely?

When controlling risks, apply the principles below, if possible in the following order:

- try a less risky option (e.g. switch to using a less hazardous chemical);
- prevent access to the hazard (e.g. by guarding);
- organise work to reduce exposure to the hazard (e.g. put barriers between pedestrians and traffic);
- issue personal protective equipment (e.g. clothing, footwear, goggles); and
- provide welfare facilities (e.g. first-aid and washing facilities for removal of contamination).

Improving occupational safety and health need not cost a lot. For instance, placing a mirror on a dangerous blind corner to help prevent vehicle accidents is a low-cost precaution considering the risks. Failure to take simple precautions can cost you a lot more if an accident does happen.

Involve staff, so that you can be sure that what you propose to do will work in practice and won't introduce any new hazards.

Step 4: record your findings and implement them

Putting the results of your risk assessment into practice will make a difference when looking after people and your operation.

Writing down the results of your risk assessment, and sharing them with your staff, encourages you to do this. When writing down your results, keep it simple, e.g. 'Tripping over rubbish: bins provided, staff instructed, weekly housekeeping checks' or 'Fume from welding: local exhaust ventilation used and regularly checked'.

A risk assessment does not have to be perfect, but it must be suitable and sufficient. You need to be able to show that:

- a proper check was made;
- you asked who might be affected;
- you dealt with all the obvious significant hazards, taking into account the number of people who could be involved;
- the precautions are reasonable, and the remaining risk is low; and
- you involved your staff or their representatives in the process.

If, like many businesses, you find that there are quite a lot of improvements, big and small, that you could make, don't try to do everything at once. Make a plan of action to deal with the most important things first. Occupational safety and health inspectors acknowledge the efforts of businesses that are clearly trying to make improvements.

A good plan of action often includes a mixture of different things such as:

- a few cheap or easy improvements that can be done quickly, perhaps as a temporary solution until more reliable controls are in place;
- long-term solutions to those risks that are most likely to cause accidents or ill health;
- long-term solutions to those risks with the worst potential consequences;
- arrangements for training employees on the main risks that remain and how they are to be controlled;
- regular checks to make sure that the control measures stay in place; and
- clear responsibilities – who will lead on what action and by when.

Remember: prioritise and tackle the most important things first. As you complete each action, tick it off your plan.

Step 5: review your risk assessment and update if necessary

Few workplaces stay the same. Sooner or later, you will bring in new equipment, substances and procedures that could lead to new hazards. It makes sense, therefore, to review what you are doing on an ongoing basis.

Look at your risk assessment and think about whether there have been any changes. Are there any improvements you still need to make? Have your seafarers spotted a problem? Have you learned anything from accidents or near misses? Make sure your risk assessment stays up to date.

When you are running a business, it's all too easy to forget about reviewing your risk assessment – until something has gone wrong and it's too late.

If there is a significant change, don't wait: check your risk assessment and, where necessary, amend it. If possible, it is best to think about the risk assessment when you're planning your change – that way you leave yourself more flexibility.

CHAPTER 2

SAFETY INDUCTION

2.1 General

International Convention on Standards of Training, Certification and Watchkeeping for Seafarers, 1978, as amended (STCW); Maritime Labour Convention, 2006 (MLC 2006)

2.1.1 In addition to any appropriate mandatory STCW-approved courses, before being assigned to shipboard duties, all persons employed or engaged on a ship, other than passengers, shall receive familiarisation training on board and receive sufficient information and instruction to be able to:

- communicate with other persons on board on elementary safety matters and understand safety information symbols, signs and alarm signals;
- know what to do if:
 - a person falls overboard;
 - fire or smoke is detected; or
 - the fire or abandon ship alarm is sounded;
- identify alarm points, muster and embarkation stations, and emergency escape routes;
- locate and don lifejackets;
- have knowledge of the use of portable fire extinguishers;
- take immediate action upon encountering an accident or other medical emergency before seeking further medical assistance on board; and
- close and open the fire, weathertight and watertight doors fitted in the particular ship other than those for hull openings.

2.1.2 It is recommended that each Company should design and implement a standard induction programme for each vessel, covering the STCW and MLC requirements, and incorporating any expanded detail specific to that vessel's particular needs. This chapter gives guidance on the subjects to be covered.

2.1.3 On completion of the standard safety induction, the new personnel should receive the appropriate security training and departmental induction covering safe working practices, areas of responsibility, departmental standing orders, and training/certification requirements to operate specific machinery or undertake specific tasks.

2.1.4 In addition, anyone employed or engaged on board a vessel in any capacity with designated safety or pollution-prevention duties should, before being assigned to any of those duties, receive appropriate basic training as listed below (in the tables from the STCW Code) relevant to those duties, and relevant refresher training as required:

- Personal survival techniques as set out in Table A-VI/1-1.
- Fire prevention and firefighting as set out in Table A-VI/1-2.
- Elementary first aid as set out in Table A-VI/1-3.
- Personal safety and social responsibilities as set out in Table A-VI/1-4.

2.2 Emergency procedures and fire precautions

*S.I. 1999/2722,
MGN 71(M)*

2.2.1 All new personnel should be given a clear explanation of the vessel's alarm signals, and instruction on the emergency assembly stations, lifeboat stations and fire drill/team requirements.

2.2.2 Smoking regulations on the vessel should be strictly observed. Safe and correct disposal of cigarette ends is essential. Smoking or non-smoking areas, as appropriate, should be identified and clearly marked. Rules concerning smoking should be strictly obeyed. E-cigarettes are a source of ignition and should not be used in hazardous areas.

2.2.3 Fire aboard a vessel can be disastrous. Common causes are:

- faulty electrical appliances/circuitry;
- overloading of electrical circuitry;
- careless disposal of cigarette ends;
- spontaneous combustion of damp or dirty waste/rags, especially if contaminated with oil;
- damp storage of linen/materials;
- spillage/leakage in machinery spaces;
- galley fires due to overheating of cooking oils;
- carelessness with hand-pressing irons; or
- incorrect methods of drying laundry.

2.2.4 Personnel should be made aware of these risks and ensure at all times that fire risks are removed where possible or kept to a minimum through good housekeeping, regular inspection and maintenance of electrical circuitry and appliances, etc.

2.3 Accidents and medical emergencies

2.3.1 All personnel should know the action to be taken in cases of accident or medical casualty on board ship. For example, as a minimum they will need to know how to raise the alarm and seek assistance.

2.4 Health and hygiene

2.4.1 It is the responsibility of individuals to ensure high standards of personal hygiene and to look after their own health. Attention should be paid to:

- personal cleanliness;
- sensible diet;
- adequate sleep during rest periods;
- regular exercise;
- avoidance of excess alcohol/tobacco;
- prompt attention to cuts/abrasions;
- maintenance of working clothes and protective equipment in a clean condition;
- appropriate dress for the work and climate; and
- avoidance of recreational drugs.

2.4.2 On international voyages, any vaccinations/inoculations required should be fully updated. Medications for the prevention of illness (e.g. anti-malarial tablets) should be taken as and when required.

2.4.3 In hot climates, it is important to protect the skin from strong sunlight and drink plenty of salt-containing liquids to replace the body fluids lost through perspiration.

2.5 Good housekeeping

2.5.1 All ships move in a seaway and as space is very limited aboard any vessel, good housekeeping is essential for safe working/access and hygiene control. Attention should be paid in particular to the:

- safe and secure stowage of loose items;
- proper securing of doors, etc.;
- good maintenance of fittings and fixtures;
- adequate illumination of all work/transit areas;

- avoidance of overloading of electrical circuits;
- clear and legible signs/operational notices; and
- proper clearance and disposal of garbage/waste materials.

2.6 Environmental responsibilities

S.I. 2008/3257
MSN 1807(M+F)

2.6.1 The maintenance of good standards to protect the environment, whether local (i.e. accommodation/work areas) or the wider environment, is important and the responsibility of all personnel. Many aspects are covered by international legislation and it is the duty of all personnel to ensure strict compliance with such legislation.

2.6.2 The handling and storage of garbage can present health and safety hazards to crews and ships. The requirements of the garbage management plan should be observed.

2.6.3 Particular attention should be paid to the correct methods of disposal of waste oils (bilge or other), chemicals, galley waste (including used cooking oil), garbage (especially plastics, glass, drums and other non-biodegradable items) and redundant items (moorings, dunnage, cargo cleanings, etc.) in line with the vessel's garbage management plan.

2.6.4 Incinerators and compactors should always be operated by competent personnel, and operating instructions should be strictly followed.

2.7 Occupational health and safety

2.7.1 All new personnel should be made aware of the Company's procedures governing occupational health and safety on board, including activity-specific requirements, such as those governing the use of lifting plant or means of access.

2.7.2 Where there are no specific regulations, the general duties contained in the Merchant Shipping and Fishing Vessels (Health and Safety at Work) Regulations 1997 apply. The main principle contained in these regulations is that all safety measures should be based on an assessment of the risks involved in a particular task, and the identification of the most effective measures to limit that risk. Guidance on risk assessment is in Chapter 1, Managing occupational health and safety.

2.8 Company and worker responsibilities

2.8.1 All new personnel should be informed of the Company's duties in respect of health and safety.

2.8.2 It is particularly important that they are reminded to follow any training, oral or written instructions that they have been given, and know to whom they should report any deficiencies in equipment or unsafe practices that they may notice.

2.8.3 Personnel who find any defects in any equipment, or a condition that they believe to be hazardous or unsafe, should immediately report it to a responsible person, who should take appropriate action.

2.9 Consultation procedures

2.9.1 New personnel must be told about the procedures for consultation on health and safety matters, including who their safety representatives are, and should be encouraged to contribute towards continuous improvement.

Blank page

CHAPTER 3

LIVING ON BOARD

3.1 General

3.1.1 The aim of the Code as a whole is to provide information and guidance aimed at improving the health and safety of those living and working on board ship. This chapter gives some more specific advice for the individual seafarer.

3.2 Fitness, health and hygiene

*MSN 1839(M) and
MSN 1815(M)*

3.2.1 It is the seafarer's responsibility to look after their health and fitness. The work of a seafarer calls for a high standard of health and fitness, and so every seafarer is required to hold a valid certificate of medical fitness (on a UK ship, ENG1 or recognised equivalent) in order to join a ship. This confirms that, at the time of the medical examination:

- the seafarer's hearing and sight, and where relevant colour vision, met the appropriate standards for their role on board; and
- the seafarer had no conditions likely to be aggravated by service at sea or make the seafarer unfit for their duties or endanger other persons on board.

3.2.2 In the event of any change in their health that may affect their fitness for duty, the seafarer should seek advice, in order that the validity of their medical certificate can be reassessed by an approved doctor. Failure to do so may invalidate the seafarer's medical certificate, and may also place them or their colleagues at risk.

3.2.3 High standards of personal cleanliness and hygiene should be maintained. On board ship, infections can easily be spread from one person to others, so preventive measures, as well as simple, effective treatment, are essential.

3.2.4 Good health depends on sensible diet, adequate sleep and regular exercise. Guidance on healthy eating is available in the Maritime and Coastguard Agency leaflet 'Your health at sea 8: Fit for purpose', or from the National Health Service (NHS) website. Recreational drugs, substance or drug misuse, excesses of alcohol and tobacco should be avoided.

3.2.5 Treatment should be sought straight away for minor injuries; cuts and abrasions should be cleaned and first-aid treatment given as necessary to protect against infection. Barrier creams may help to protect exposed skin against dermatitis and also make thorough cleansing easier.

3.2.6 Rats and other rodents may be carriers of infection and should never be handled, dead or alive, with bare hands.

3.2.7 Personnel on board ship are trained and equipped to provide initial medical care for the range of health problems that may arise. If a seafarer develops a serious health problem or suffers a serious injury, medical advice should be obtained from tele-medical services. Where necessary, arrangements may be made to transport the sick or injured seafarer ashore for medical treatment. Further advice on medical care is contained in *The Ship Captain's Medical Guide*.

3.3 Smoking

3.3.1 Tobacco smoke damages the health of smokers and of those exposed to second-hand smoke. As well as the immediate harmful effects of smoking, it can increase susceptibility to harmful substances including asbestos. Many Companies, therefore, have a smoking policy as part of their promotion of health and safety on board. This policy, while taking into account the extent to which the ship is also the seafarers' home and place of recreation, will usually give priority to protecting non-smokers from the risk of harm from second-hand smoke.

3.3.2 A smoking policy is therefore likely to limit the places on the ship where smoking is permitted, and to include educating smokers of the health benefits of giving up smoking, and promoting schemes to help seafarers to quit. Guidance is also available on the NHS website.

3.3.3 In addition to the health risks, smoking may create a fire risk if matches and cigarettes are not carefully extinguished and disposed of safely. Ashtrays should always be used where provided. The use of safety ashtrays is to be preferred.

3.3.4 Matches and cigarette ends should not be thrown overboard since there is a danger that they may be blown back on board. It is particularly dangerous to smoke in bed.

3.4 Medication

MSN 1839(M)

3.4.1 Anyone taking medication, particularly any medication that may affect alertness, should declare this to the approved doctor conducting their medical examination, and discuss any possible side effects. They should also notify a responsible officer on board, so that allowance may be made in allocating tasks.

3.4.2 Drinking alcohol whilst under treatment with certain medications should be avoided, since even common remedies such as aspirin, seasickness tablets, anti-malarial tablets and codeine may be dangerous in conjunction with alcohol.

3.4.3 The individual has a responsibility to ensure that inoculations and vaccinations required for international voyages are kept up to date and that medications for the prevention of illness, such as suitable anti-malarial tablets, are taken when required.

3.5 Malaria

MGN 399(M)

3.5.1 Preventative medication for malaria must be started in advance of arriving in an affected area. The length of time may vary according to treatment, but around one to three weeks is normal. Medication should continue for four weeks after leaving the area. The Company will need to take medical advice on the best medication for particular areas.

3.5.2 While in infected areas, precautions should be taken to minimise the risk of insect bites.

Protection from insect bites

- Wear long-sleeved tops and trousers when going on deck or ashore.
- Use mosquito wire-screening and nets.
- Keep openings closed.
- Use anti-mosquito preparations or insecticides.

3.5.3 Anyone who falls ill after being in an infected area should inform a doctor immediately that they have been exposed to the risk of malarial infection.

3.5.4 More detailed guidance on prevention is in marine guidance note MGN 399(M) and on prevention and care in *The Ship Captain's Medical Guide*.

3.6 Avoiding the effects of fatigue (tiredness)

IMO, MSC/
Circ.813

3.6.1 The International Maritime Organization (IMO) defines fatigue as: 'A reduction in physical and/or mental capability as the result of physical, mental or emotional exertion which may impair nearly all physical abilities including: strength; speed; reaction time; coordination; decision making; or balance.'

3.6.2 Fatigue amongst seafarers is recognised as a serious issue affecting maritime safety. There is clear evidence that fatigue is a contributory cause of accidents, injuries, death, long-term ill health, major damage to and loss of vessels, and enormous environmental harm.

3.6.3 The Company and the master should ensure that work is organised in such a way as to minimise fatigue, but seafarers also have a duty to take care of their own health and safety and that of their fellow workers.

Preventing fatigue

- Ensure you arrive on board well rested at the start of a period of work.
- Take scheduled rest periods.
- Use rest periods to gain adequate, uninterrupted sleep as far as possible (research suggests the body needs about 8 hours of sleep in each 24 hours in total).
- Eat regular, well-balanced meals, but eat lightly before sleep.
- Avoid alcohol and caffeine before sleep.
- Record hours of rest accurately, so that if there are workload pressures at particular times, this becomes apparent to management.

MGN 505(M)

3.6.4 Further information about fatigue, making the most of sleep patterns and ways to maintain alertness are in MGN 505(M).

3.7 Working in hot or sunny climates and hot environments

3.7.1 High humidity and high temperatures can lead to heat exhaustion and heat stroke. Perspiration is the body's best heat-control mechanism, but sweat consists mainly of salt and water which must be replaced. When working in these conditions, it is advisable to drink at least 4.5 litres (8 pints) of cool (but not iced) water daily. It is best to take small quantities at frequent intervals. Salt can be taken in food, supplemented by salt-containing drinks to prevent heat cramps. Alcohol should be avoided.

3.7.2 The length of time that seafarers are exposed to the hot conditions should be limited, and breaks (in the shade or in the fresh air) should be provided. Mechanical aids to support physically demanding work will help to reduce the impacts of hot environments or when seafarers are wearing a lot of clothing or equipment. See guidance from the Health and Safety Executive (HSE) on thermal comfort.

3.7.3 If working in an enclosed space, steps should be taken to ensure that the space is ventilated as well as possible. Light clothing should be worn, in order to allow the largest possible surface for free evaporation of sweat.

3.7.4 In tropical areas especially, exposure to the sun should be avoided as far as possible, particularly during the hottest part of the day. When it is necessary to work in exceptionally hot or humid conditions, appropriate clothing (including a hat) offering protection to both body and head should be worn. Light cotton clothing will reflect the heat and help to keep the body temperature down. Keep the upper body covered,

especially around midday when the sun is at its hottest. Skin that has not been exposed to the sun for several months burns very easily.

3.7.5 Using sunscreen can add useful protection for the seafarer's body, which it is not easy to shade from UVA and UVB rays and sunlight. In European climatic regions, use a sun protection factor (SPF) rating of at least 15. In tropical regions or other areas of high risk, use a SPF of at least 30 (or higher for those with fair skin).

Don't get burnt

- Get to know your skin. This will help decide what precautions you need to take. Getting burnt now might increase the chances of developing skin cancer in later years.
- Try to avoid reddening – it is the first sign of skin damage as well as being an early sign of burning.
- A suntan **may** give some protection against burning but does not eliminate the long-term cancer risk; nor will it protect against premature ageing.
- The best protection is to shade the skin from direct sunlight.
- When on leave, continue to take care as the skin remembers every exposure.
- Use sunscreen generously and reapply regularly.

3.7.6 When working in exceptionally hot and/or humid conditions or when wearing respiratory equipment, breaks at intervals in the fresh air or in the shade may be necessary. Protective clothing and equipment should be removed during breaks, to allow the body to cool down, but it must be replaced before work restarts.

3.8 Working in cold climates and environments

3.8.1 Working in cold climates can impair the seafarer's ability to carry out simple tasks, as the cold temperatures can severely affect dexterity. At even colder temperatures, deeper muscles are affected, which results in reduced muscular strength and stiffened joints. (See the guidelines for working in cold weather on the York University, Canada website.)

3.8.2 Early signs that the body is under stress from the cold include:

- persistent shivering;
- poor coordination;
- blue lips and fingers;
- irrational or confused behaviour; and
- reduced mental alertness.

3.8.3 Appropriate clothing should be worn, including gloves, hat and warm socks. Care should be taken to ensure that this is compatible with any personal protective equipment needed for the work in hand.

Cold weather-related injuries/conditions

Frostbite/frostnip can damage the skin and tissue of the parts of the body that are left exposed to freezing temperatures. Extremities, specifically hands, feet, ears, nose and lips, are particularly vulnerable. Clothing that protects the extremities should be worn.

Hypothermia is caused when the body's core temperature falls below 35°C (95°F) and can become life threatening. It is usually caused by being in a cold environment such as being outdoors in cold conditions for a long period of time or falling into cold water.

(See the National Health Service (NHS) Choices website for information on frostbite and hypothermia.)

3.9 Working clothes

3.9.1 Clothing should be appropriate for the working conditions. Working clothes should be close-fitting with no loose flaps, pockets or ties, which could become caught up in moving parts of machinery or on obstructions or projections. Where there is a risk of burning or scalding, as in galleys, clothing and shoes should adequately cover the body and material should be of low flammability, such as cotton.

3.9.2 Shirts or overalls provide better protection if they have long sleeves. Long sleeves should not be rolled up. Long hair should be tied back and covered. Industrial or safety footwear should be worn when appropriate.

3.10 Shipboard housekeeping

3.10.1 Good housekeeping is an essential element in promoting health and safety on board:

- Equipment and other items should be safely and securely stored. This ensures not only that defects are discovered but also that articles can be found when required.
- Fixtures and fittings should be properly maintained.
- All work and transit areas should be adequately lit.
- Electric circuits should not be overloaded, particularly in cabins.
- Garbage and waste materials should be cleared up and disposed of correctly and promptly.
- Doors and drawers should be properly secured.

- Emergency signage and fire and life-saving equipment should be kept clear at all times.
- Instruction plates, notices and operating indicators should be kept clean and legible, and should not be obstructed by other items.

3.10.2 Aerosols may have volatile and inflammable contents. They should never be used or placed near naked flames or other heat source even when empty. Empty canisters should be properly disposed of.

3.10.3 Some fumigating or insecticidal sprays contain ingredients which, though perhaps themselves harmless to human beings, may be decomposed when heated. Smoking may, therefore, be dangerous in sprayed atmospheres until the spray has dissipated and the area has been ventilated.

3.11 Substances hazardous to health

3.11.1 Many substances found on ships are capable of damaging the health of those exposed to them. They include not only recognised hazard substances, such as dangerous goods cargoes and asbestos, but also some maintenance and cleaning substances. For example, caustic soda and bleaching powders or liquids can burn or penetrate the skin. They may react dangerously with other substances and should never be mixed.

3.11.2 Where personnel are working in the presence of substances hazardous to health, appropriate safety measures should be followed to remove, control or minimise the risk of exposure. Packaged cargoes and stores should carry hazard-warning labels, where appropriate. Other hazardous substances should be identified through risk assessment and seafarers given information about the hazards and the measures in place to protect them.

3.11.3 It is important to read carefully all labels on chemical containers before opening them, to find out about any hazards from the contents. A chemical from an unlabelled container should never be used unless it can be clearly established what it is. Further advice is in Chapter 21, Hazardous substances and mixtures.

3.11.4 Older ships may have asbestos-containing products in panels, cladding or insulation. Any damage to such materials in the course of a voyage should be reported immediately to the departmental head. Until the damage can be repaired properly, the area should be sealed off where possible and the exposed edges or surfaces insulated or covered. This will prevent asbestos fibres from being released and dispersed in the air.

3.11.5 Prolonged exposure to mineral oils and detergents may cause skin problems. All traces of oil should be thoroughly washed from the skin. A skin cleaner that is designed for oil removal should be used. Chemical

solvents should not be used as they may damage the skin. Inadvertent contact with toxic chemicals or other harmful substances should be reported immediately and the appropriate remedial action taken. Working clothes should be laundered frequently. Oil-soaked rags should not be put in pockets.

3.11.6 Coughs and lung damage can be caused by breathing irritant dust. The risk is usually much greater for a person who smokes than for a non-smoker.

3.11.7 Seafarers should ensure that they are aware of and understand the risks arising from their work, the precautions to be taken and the results of any monitoring of exposure.

3.11.8 Personnel should always comply with any control measures in place, and wear any protective clothing and equipment supplied.

3.11.9 In cases where failure of the control measures could result in serious risks to health, or where their adequacy or efficiency is in doubt, this should be reported so that health surveillance can be undertaken.

3.12 Common personal injuries

Chapter 8 includes advice on suitable personal protective equipment that will help to prevent the following injuries.

Hand injuries

3.12.1 Gloves are a sensible precaution when handling sharp or hot objects but they may easily get trapped on drum ends or on machinery. While loose-fitting gloves allow hands to slip out readily, they do not give a good grip on ladders. Wet or oily gloves may be slippery and great care should be taken when working in them. Wearing gloves for long periods may make skin hot and sweaty leading to damage. Wearing separate cotton gloves inside protective gloves will help to prevent this.

Foot injuries

3.12.2 Unsuitable footwear (such as sandals, plimsolls and flip-flops) gives little protection if there is a risk of burning or scalding, for example, and may lead to trips and falls. Care should be taken to keep feet away from moving machinery, bights of ropes and hawsers.

Eye injuries

3.12.3 Great care should be taken to protect the eyes. Appropriate protective goggles should be worn for any work involving sparks, chips of wood, paint or metal, and dangerous substances.

Head injuries

3.12.4 It is important to remember to duck when stepping over coamings, etc. to avoid hitting the head on the door frame, and head protection should be worn where appropriate.

Cuts

3.12.5 To avoid cuts, all sharp implements and objects should be handled with care. They should not be left lying around where someone may accidentally cut themselves. In the galley, sharp knives and choppers should not be mixed with other items for washing up but cleaned individually and stored in a safe place. Broken glass should be swept up carefully, not picked up by hand.

Burns and scalds

3.12.6 Burns and scalds are commonly caused by hot pipelines and stoves, as well as by fires. Every hot machine and every container of scalding liquid should be regarded as a hazard, capable of causing injury, and adequate precautions should be taken.

3.12.7 Faulty electrical equipment can cause severe burns as well as an electric shock. Equipment should be checked before use and if something appears wrong, it should be reported.

Misuse of tools

3.12.8 Injury can be caused by the misuse of tools. It is important always to use the correct tool for the job, and to make sure it is used in the right way. Tools should never be left lying around where they can fall on someone, or be tripped over. After a job is finished, they should be put away in a safe place.

Manual handling

3.12.9 It is easy to strain muscles when manual handling. Pulled muscles may be avoided if proper lifting techniques are used. Chapter 10 gives guidance on handling loads.

Mooring

3.12.10 Mooring and unmooring operations provide the circumstances for potentially serious accidents. Personnel should never stand in the bight of a rope or near a rope under tension, and they should treat ropes on drums and bollards with the utmost care.

Electrical hazards

3.12.11 Unauthorised persons should not interfere with electrical fittings. No personal electrical appliance should be connected to the ship's electrical supply without approval from a responsible officer.

3.12.12 Clothing or other articles should be left to dry only in designated areas, not in machinery spaces or over or close to heaters or light bulbs. This may restrict the flow of air and so lead to overheating and fire.

3.12.13 Hand-pressing irons should not be left standing on combustible materials. They should be switched off after use and stowed safely.

3.13 Sunglasses

3.13.1 The bright light from the sun reflecting off the surface of a calm sea or from ice caps in the Polar regions, or from the vessel itself, can dazzle the seafarer and cause damage to the eyes.

3.13.2 In these conditions, seafarers working on the bridge or on the open deck should wear sunglasses, which are an important piece of protective equipment, rather than tinted eye protection. For protection on the bridge, collective protection systems should always be considered; for example, sunblinds.

3.13.3 The following guidance should be considered when purchasing sunglasses.

- The lens tint should be neutral – ideally either grey or brown as these cause the least colour distortion.
- The lens tint should be no darker than 80% absorption.
- A graduated tint, with the darkest at the top of the lens, lightening towards the bottom, may be useful.
- Glasses should be CE marked and to the British Standard BS EN ISO 12312-1:2013+A1:2015. BS EN ISO 12311:2013 ensures that the sunglasses offer a safe level of ultraviolet protection.

3.13.4 Photochromic lenses react with UV radiation by darkening. Sunglasses with photochromic lenses **must not** be worn during the hours of darkness as they can significantly reduce night vision. Information is given in MGN 397(M+F).

3.13.5 Polarised lenses reduce the amount of light passing through the lens by selective filtering of certain electromagnetic spectral planes. The use of this type of lens should also be discouraged. However, in some situations; for example, when navigating in shallow water, the wearing of these lenses may be beneficial as they can reduce the reflected glare from the surrounding water. Polarised lenses must not be used when viewing instrument panels as the visibility of some images may be unclear.

3.13.6 All frames should be well fitting and large enough to allow sufficient protection from oblique sunlight. All seafarers requiring a spectacle prescription must have a clear pair of correcting lenses but can

BS EN ISO
12311:2013

BS EN ISO 12312-
1:2013+A1:2015

MGN 397(M+F)

have prescription sunglasses as their second pair. The wearing of non-prescription sunglasses on top of prescription glasses is not permitted. For navigational watches during the hours of darkness, the wearing of any type of sunglasses is not recommended.

3.14 Risk from sharps

Introduction

3.14.1 The term 'sharps' includes needles, syringes and razor blades.

3.14.2 Sharps may be used for the treatment of medical conditions, for recreational drug use or for wet shaving. Housekeeping staff may, therefore, come across these items in bed linen, on surfaces or in bins, and precautions should be taken to avoid injury and the risk of contamination with blood-borne viruses (BBVs). The main BBVs or concerns are:

- hepatitis B (HBV);
- hepatitis C (HCV); and
- human immunodeficiency virus (HIV).

There is a risk of bacterial or viral infection from used sharps.

3.14.3 As there is always a potential risk of coming across sharps unexpectedly, advice should be taken from a medical practitioner about whether seafarers exposed to this risk should have a tetanus or hepatitis B vaccination as a precaution. [For UK residents, these are provided free of charge on the NHS.]

3.14.4 The following precautions will reduce the risk:

- All housekeeping staff should be trained in safe systems of work, and what action to taken if they come across a sharp.
- Supervisors should be familiar with the safe systems of work and what to do in the event of injury.

Rubbish collection

3.14.5 Items should never be removed by hand from the bin.

3.14.6 Where bin liners are used, a check should be made that the weight is ok to lift, and then the liner should be removed fully from the bin and placed in a sturdy rubbish collection sack. To reduce the risk of being accidentally stabbed with a discarded needle or razor, hands should never be put inside a sack or a bin when emptying the contents.

3.14.7 Where no bin liner is in use, a check should be made that the weight of the bin is ok to lift, and then the contents should be emptied directly into a sturdy rubbish collection sack.

3.14.8 The collection sack should not be overfilled. If the contents need to be compressed, this should be done with a brush or other similar object, not with the hands.

3.14.9 Any rubbish sack should be carried as far from the body as possible, to prevent any unseen sharp objects causing injury. If it becomes apparent that there are sharp objects in the bag, the bag should be placed on the floor and appropriate assistance should be sought.

Cleaning/housekeeping

3.14.10 Care should be taken to avoid putting hands into blind/obstructed areas; for example, toilet U-bends or under sheets or pillows.

3.14.11 All needles/syringes found must be disposed of in a sharps container (or rigid-sided container), following the safe system of work (see section 3.14.4). If a sharp is found, it should always be assumed that it is infectious. The area should be closed off immediately to all personnel and a supervisor should be notified. The incident should be reported to a supervisor so that a record can be kept of the location, date and time as a hazardous occurrence.

3.14.12 Broken glass and crockery should be handled carefully and wrapped in several sheets of paper before being placed in the bin.

Removal of sharps: safe working procedure

3.14.13 Only trained staff should remove sharps.

3.14.14 When sharps are found, they should never be carried to a sharps container for disposal. The sharps container should be taken to where the sharp has been found, and placed near the sharp.

3.14.15 Sharps should never be picked up with bare hands or passed from hand to hand. Either:

- appropriate protective clothing (stout rigger, rubber gloves or specialist anti-needle gloves) should be worn if removing the sharp with a small pair of tongs; or
- a long-handled litter-picking device should be used to pick up the sharp. No gloves are needed in this case as the distance between the sharp and the individual reduces the risk of contact.

3.14.16 Sharps should not be put in a normal waste bin. Always use a sharps container. The sharps container should not be filled beyond the level indicated on the side.

3.14.17 No attempt should be made to re-sheath or bend the needle.

If an injury occurs

3.14.18 If the skin is pierced by a needle or razor blade:

- The wound should be gently encouraged to bleed, but not scrubbed or sucked.
- The wound should be washed with soap and water.
- The incident should be reported immediately to a supervisor.
- Unless there is a doctor on board, radio medical advice should be sought.

Blank page

CHAPTER 4

EMERGENCY DRILLS AND PROCEDURES

*MGN 71(M) and
MSN 1579(M)
S.I. 1999/2722*

4.1 Musters and drills

4.1.1 Musters and drills are required to be carried out regularly in accordance with merchant shipping regulations. The guidance contained in this and the following sections should be read in conjunction with information and guidance on these regulations issued in the relevant marine notices.

4.1.2 Musters and drills are designed to prepare a trained and organised response to dangerous situations, which may unexpectedly threaten loss of life and property at sea, and are also for protection of the marine environment. It is important that they should be carried out realistically, approaching emergency conditions as closely as possible while ensuring the safety of personnel. Changes in a ship's function and personnel from time to time should be reflected in corresponding changes in the muster arrangements.

4.1.3 The muster list must be conspicuously posted before the ship sails and, on international voyages and in passenger ships of classes IIA and III, should be supplemented by emergency instructions for each seafarer, e.g. in the form of a card issued to each seafarer or affixed to individual seafarer berths and bunks. These instructions should describe the allocated assembly station, survival craft station and emergency duty, and all emergency signals and action, if any, to be taken on hearing such signals.

*Reg. 8(4), Reg.
12(2) and (3)*

4.1.4 An abandon ship drill and a fire drill shall be held within 24 hours of leaving port if more than 25% of the crew have not taken part in drills on board the ship in the previous month. On passenger vessels of class I, this shall be carried out prior to or immediately upon departure. As soon as possible after joining the ship, on-board training in the use of the ship's life-saving appliances, including survival craft and evacuation systems, must be given to seafarers. As soon as possible after joining the ship, seafarers should also familiarise themselves with their emergency duties, the significance of the various alarm systems and the locations of their lifeboat station and of all life-saving and firefighting equipment. When a ship enters service for the first time after modification of a major character or when a new crew is engaged, these drills shall be held before sailing.

4.1.5 All the ship's personnel concerned should muster/assemble at a drill wearing lifejackets that are properly secured. The lifejackets should continue to be worn during lifeboat drills and launchings but in other cases may be subsequently removed at the master's discretion if they would impede or make unduly onerous the ensuing practice, provided they are kept ready to hand.

4.1.6 The timing of emergency drills should vary so that personnel who have not participated in a particular drill may take part in the next.

4.1.7 Any defects or deficiencies revealed during drills and the inspections that accompany them should be made good without delay.

4.2 Fire drills

4.2.1 Training in firefighting procedures and maintenance of equipment should be carried out by participating in regular drills in accordance with regulatory requirements. Access to firefighting equipment should be kept clear at all times and emergency escapes and passageways should never be obstructed.

4.2.2 Effective firefighting demands the full cooperation of seafarers in all departments of the ship. A fire drill should be held simultaneously with the first stage of the abandon ship drill. Firefighting parties should assemble at their designated stations. Engine room personnel should start the fire pumps in machinery spaces and see that full pressure is put on fire mains. Any emergency fire pump situated outside machinery spaces should also be started; all nominated seafarers should know how to start and operate the emergency fire pumps.

4.2.3 The fire parties should be sent from their designated stations to the location of the supposed fire, taking with them emergency equipment such as radios, axes, lamps and breathing apparatus. The locations should be changed in successive drills to give practice in differing conditions and in dealing with different types of fire so that accommodation, machinery spaces, store rooms, galleys and cargo holds, and high-risk fire areas are all covered at regular intervals.

4.2.4 An adequate number of hoses to deal with the assumed fire should be realistically deployed. At some stage in the drill, they should be tested by bringing them into use. Hoses should be tested by the general service pump and by emergency fire pumps.

4.2.5 The drill should extend, where practicable, to the testing and demonstration of the remote controls for ventilating fans, fuel pumps and fuel tank valves, the closing of openings and the appropriate isolation of electrical equipment.

4.2.6 Fixed fire-extinguishing installations should be tested to the extent practicable.

4.2.7 Portable fire extinguishers should be available for demonstration of their use. This should include different types applicable to different kinds of fire. At each drill, one extinguisher or more should be operated by a member of the fire party, a different member on each occasion. As far as practicable, different types of extinguishers available on board should be used on a rotational basis. The operation of extinguishers that cannot be charged on board should be explained. Extinguishers so used should be recharged before being returned to their normal location or sufficient spares should otherwise be carried for demonstration purposes.

S.I. 1998/2514

4.2.8 Each member of the firefighting party should be trained in the use of breathing apparatus as part of the drill. Search and rescue exercises should be undertaken in various parts of the ship. The apparatus should be cleaned and verified to be in good order before it is stowed. Cylinders of self-contained breathing apparatus should be recharged and seafarers should be trained in this procedure. Otherwise, sufficient spare cylinders should be carried for this purpose.

4.2.9 Fire appliances, fire and watertight doors, other closing appliances, and fire detection and alarm systems that have not been used in the drill should be inspected in accordance with the ship's safety management system.

4.3 Action in the event of fire

4.3.1 The risk of fire breaking out on board a ship cannot be eliminated but its effects will be much reduced if the advice given in this chapter is conscientiously followed.

4.3.2 A fire can usually be extinguished most easily in its first few minutes. Prompt and correct action is essential.

4.3.3 The alarm should be raised and the bridge informed immediately. If the ship is in port, the local fire authority should be called. If possible, an attempt should be made if safe and practicable to extinguish or limit the fire, by any appropriate means readily available, either using suitable portable extinguishers or by smothering the fire as in the case of a fat or oil fire in the galley.

4.3.4 The ship's personnel should be aware of the use of different types of fire extinguisher and their suitability for different types of fire. Water extinguishers should not be used on oil or electric fires and foam extinguishers should not be used on electrical fires.

4.3.5 Openings to the space should be shut to reduce the supply of air to the fire and to prevent it spreading. Any fuel lines feeding the fire or threatened by it should be isolated.

4.3.6 If practicable, combustible materials adjacent to the fire should be removed, boundary cooling of adjacent compartments should be considered and temperatures monitored if spaces are not otherwise accessible.

4.3.7 If a space is filling with smoke and fumes, any seafarers not properly equipped with breathing apparatus should leave the space without delay; if necessary, escape should be effected by crawling on hands and knees because the air close to deck level is likely to be relatively clear. Where available, emergency escape breathing devices (EEBDs) should be used.

4.3.8 After a fire has been extinguished, precautions should be taken against its spontaneous re-ignition.

4.3.9 Seafarers should not re-enter a space in which a fire has occurred without wearing breathing apparatus until it has been fully ventilated.

4.4 Abandon ship drills

4.4.1 When arranging drills, reference should be made to the relevant marine notices. Arrangements for drills should take account of prevailing weather conditions.

4.4.2 Seafarers taking part in life raft or lifeboat drills should muster wearing warm outer clothing and lifejackets that have been properly secured.

4.4.3 In addition to the statutory inspection, an opportunity should be taken to ensure all wires are in good condition, and sheaths and working parts are operational and well lubricated. A safety harness should be worn if there is any risk of falling from the davit or boat.

4.4.4 Where the handle of the lifeboat winch would rotate during the operation of the winch, it should be removed before the boat is lowered on the brake or raised with an electric motor. If a handle cannot be removed, seafarers should keep well clear of it.

4.4.5 When turning out davits or when bringing boats or rafts inboard, seafarers should always keep clear of any moving parts.

4.4.6 The engines on motor lifeboats should be started and run ahead and astern. Care should be taken to avoid overheating the engine and the propeller shaft's stern gland. All seafarers should be familiar with the engine-starting procedure.

4.4.7 Radio life-saving appliances should be examined and tested, and seafarers instructed in their use.

4.4.8 Water spray systems, where fitted, should be tested in accordance with the lifeboat manufacturer's instructions.

*S.I. 1999/2722
Reg. 10(6)*

4.4.9 When a drill is held in port, as many lifeboats as possible should be cleared and swung out. Each lifeboat should be launched and manoeuvred in the water at least once every three months. This should be done in accordance with current advice and recommendations in the relevant MSNs and MGNs. Personnel should avoid being in the boat when it is lowered or raised from the water. However, the launching crew may need to be on board.

MGN 560(M)

4.4.10 The monthly drills with free-fall lifeboats should be carried out according to the manufacturer's instructions, so that those who are to enter the boat in an emergency are trained to embark the boat, to take their seats in a correct way and to use the safety harnesses; and are also instructed on how to act during launching into the sea. Due to the high-risk level involved in fully launching a free-fall lifeboat with personnel on board, this should not be carried out during drills. Where available, simulated launching including a simulated release with restraining and/or recovery devices should be carried out in accordance with the manufacturer's instructions and MGN 560(M).

4.4.11 Where fast-rescue boats/rescue boats are carried that are not lifeboats, they should be launched and manoeuvred in the water every month as far as is reasonable and practicable. The interval between such drills must not exceed three months.

Reg. 10(7)

4.4.12 Where simultaneous off-load/on-load release arrangements are provided, great care should be exercised to ensure that the hooks are fully engaged prior to launching, before recovery and after stowage. Fall preventer devices should be used as appropriate in accordance with the relevant MSN.

4.4.13 On-board training in the use of davit-launched life rafts shall take place at intervals of not more than four months on every ship fitted with such appliances. Whenever practicable, this shall include the inflation and lowering of a life raft. This life raft may be a special life raft intended for training purposes only, which is not part of the ship's life-saving equipment; such a special life raft shall be conspicuously marked.

4.4.14 The release mechanism of a davit-launched life raft should not be cocked until just prior to the raft landing on the water.

4.4.15 Personnel in a fast-rescue boat/rescue boat or survival craft being lowered should remain seated, keeping their hands inside the craft to

avoid them being crushed against the ship's side. Lifejackets should be worn. In totally enclosed lifeboats, seat belts should be secured.

4.4.16 During drills, lifebuoys and lines should be readily available at the point of embarkation.

4.4.17 While boats are in the water, crews should practise manoeuvring the craft by oar, or the appropriate motive power.

4.4.18 Seafarers should keep their fingers clear of the long-link when unhooking or securing blocks onto lifting hooks while the boat is in the water, particularly if there is a swell.

4.4.19 Before craft in gravity davits are recovered by power, the operation of the limit switches or similar devices should be checked.

4.4.20 Where life rafts are carried, instruction should be given to seafarers in their launching, handling and operation. Methods of boarding life rafts and the disposition of equipment and stores on them should be explained.

4.4.21 Life-saving appliances must be maintained at all times. If the use of a life raft for practice would bring equipment below the specified scale, a replacement must first be made available.

4.5 Action in the event of abandoning ship

4.5.1 The order to abandon ship can only be given verbally by the master.

4.5.2 Everyone on board should assemble at their assembly/muster point wearing warm clothing and their lifejackets.

4.5.3 Any additional provisions, water or equipment should be brought and placed in the lifeboat.

4.5.4 A check of personnel should be taken and the lifeboat lowered under the direction of the person in charge.

4.6 Man overboard drills

4.6.1 When arranging drills, reference should be made to relevant documentation including *Man Overboard! Guidelines to shipping companies on procedures in cases of man overboard* by the National Maritime Occupational Health and Safety Committee (NMOHSC) and the *Bridge Procedures Guide* by the International Chamber of Shipping (ICS).

4.6.2 As far as reasonably practicable, man overboard (MOB) drills involving the manoeuvring of the vessel should be conducted at regular intervals.

4.6.3 Where a fast-rescue craft (FRC) is carried, so far as is reasonably practicable, this should be launched each month and tested in the water in a harbour or safe anchorage.

4.6.4 In addition to the statutory inspection, an opportunity should be taken to ensure all wires are in good condition, and sheaths and working parts are operational and well lubricated. A safety harness should be worn if there is any risk of falling.

4.6.5 Prior to the launching of the rescue boat, communications with the deck and bridge should be checked.

4.6.6 There should be no more than two persons in the boat when being launched and recovered.

4.6.7 Working lifejackets that do not restrict free movement should be worn.

4.6.8 Survival suits should be worn where there is a risk of hypothermia.

4.6.9 Other protective clothing should be worn including helmet, gloves, safety shoes and suitable clothing.

4.6.10 Drills conducted in harbour or anchorages should be as realistic as possible and include practice of manoeuvring the craft and recovery from the water of a training dummy or manikin.

4.6.11 Rescue boat crews should receive training on correct techniques for retrieving persons from the water without sustaining injury.

4.7 Action in the event of man overboard

4.7.1 Where a person is seen to fall over the ship's side, immediate action should be taken by the officer of the watch and bridge team in accordance with guidance documents referenced in section 4.6.1.

4.7.2 If a person is reported missing, appropriate action should be taken in accordance with the guidance documents referenced in section 4.6.1.

4.7.3 The master, on taking charge, should consider all options for the recovery of the person including directly from the sea via a bunker or pilot door; ladder or gangway; crane or davit; FRC or other boat.

4.7.4 The master should ensure that all preparations are made for receiving the casualty in accordance with *Man Overboard!* (NMOHSC guidelines).

4.8 Dangerous (enclosed) space drills

4.8.1 Drills and rescue from dangerous (enclosed) spaces – Chapter 15 should be read in conjunction with these guidelines where more information can be found.

4.8.2 There is a regulatory requirement for dangerous space entry and rescue drills to be carried out at least every two months.

4.8.3 Instruction should be given in the correct equipment that should be assembled prior to entry, procedures to be followed and how to use a portable oxygen/multimeter.

4.8.4 Instruction should be given on the rescue of a person(s) from a dangerous space. The drills should be varied to include a range of spaces as listed in Chapter 15.

4.8.5 Regular drills should prove the feasibility of the ship's rescue plan under different and difficult circumstances. A non-dangerous space should be used, provided that it has realistic conditions for an actual rescue, or if necessary the space should be made safe before use.

4.8.6 Each drill should be recorded in the official logbook.

4.9 Action in the event of a dangerous space emergency

4.9.1 Any attempt to rescue a person who has collapsed within a space should be based on a pre-arranged plan, which should take account of the design of the individual ship. The allocation of personnel to relieve or back up those first into the space should be borne in mind.

4.9.2 If there are indications that the person in the space is being affected by the atmosphere, the person outside the space should immediately raise the alarm. **On no account should the person stationed at the entrance to the space attempt to enter it before additional help has arrived. No one should attempt a rescue without wearing breathing apparatus and a rescue harness and, whenever possible, communication equipment and a lifeline.**

4.9.3 Under no circumstances must emergency escape breathing devices be used to enter a dangerous space to effect rescue.

4.10 Assisting a casualty

4.10.1 Anyone on board ship may find a casualty and everyone should know the basic priorities for action, the positioning of an unconscious casualty and how to give artificial respiration. These actions may save life until more qualified help arrives.

- Seafarers encountering a casualty should first ensure that they are not themselves at risk.
- If necessary, the casualty should be removed from danger, or danger removed from the casualty – **but see below on casualties in a dangerous space.**
- If there is only one unconscious casualty (irrespective of the total number of casualties):
 - Immediate basic treatment should be given to the unconscious casualty.
 - Then help should be summoned.
- If there is more than one unconscious casualty:
 - Help should be summoned first.
 - Then appropriate treatment should be given, priority being given to any casualty who is not breathing or whose heart has stopped.
- If the unconscious casualty is in a dangerous space:
 - Seafarers **must not** enter the dangerous space. **The alarm should be raised.**
 - It must be assumed that the atmosphere in the space is unsafe. The rescue team **must not** enter unless wearing breathing apparatus.
 - Separate breathing apparatus or resuscitation equipment should be fitted on the casualty as soon as possible.
 - The casualty should be removed quickly to the nearest safe adjacent area outside the dangerous space.

4.10.2 Should it be necessary to remove injured persons from a hold, the best available method should be adopted but, where practicable, all access openings should be opened and the following equipment used:

- A manually operated davit, suitably secured over the access opening.
- A cage or stretcher fitted with controlling lines at the lower end.

4.10.3 Where a casualty has been injured, is unconscious and/or has been exposed to a hazardous chemical, advice should be sought from ashore.

4.11 Drills for leakage and spillage

4.11.1 Drills should be conducted to simulate a leakage or spillage of a dangerous or hazardous substance.

4.11.2 Instruction should be given in the location of emergency equipment and its use. Instruction should also be given on potential dangers and precautions to be taken. This information can be found in the International Maritime Dangerous Goods (IMDG) Code, the IMO Emergency Procedures for Ships Carrying Dangerous Goods (EmS) and the vessel's shipboard oil pollution emergency plan (SOPEP).

4.12 Action in the event of a leakage or spillage

4.12.1 Recommendations on emergency action differ depending on type of vessel, where the goods are stowed and whether a substance is gaseous, liquid or solid. When dealing with incidents involving flammable gases or flammable liquids, all sources of ignition (e.g. naked lights, unprotected light bulbs, electric hand tools) should be avoided.

4.12.2 In the event of a leakage or spillage of any dangerous goods, the appropriate personal protective equipment (PPE) should be worn during any clean-up operation.

4.12.3 Consideration of the hazards presented by the substance should be given including whether they are toxic, corrosive, flammable or may produce dangerous vapours. PPE should be selected and worn in accordance with information provided by the IMDG Code and/or material safety data sheet, and may include eye protection, a dust mask and protective clothing. If the substance is a significant toxic hazard, self-contained breathing apparatus should be used.

4.12.4 Disposal of dangerous goods overboard is a matter for judgement by the master, bearing in mind that the safety of seafarers has priority over pollution of the sea. If it is safe to do so, spillages and leakages of substances, articles and materials identified in the IMDG Code as **marine pollutant** should be collected in receptacles for safe disposal ashore. Absorbent material should be used for liquids.

4.12.5 Spillages collected may need to be stowed safely for ultimate disposal ashore. Collection of spillages with absorbent material in a space may not be fully effective, and precautions for entry into dangerous spaces should be observed even if the space would not normally be considered a dangerous space.

4.12.6 A careful inspection for structural damage should be carried out after dealing with spillages of highly corrosive substances.

4.12.7 Water is generally recommended as the firefighting medium for most dangerous goods at sea. However, reference should be made to the relevant EmS schedules.

4.12.8 Where possible, any package of dangerous goods should be removed from the vicinity of a fire.

4.12.9 Where there is a possibility that the heat will cause a chemical or physical change in the substance, or affect the integrity of a package of dangerous goods, leading to rupture and dispersal of the contents, keeping the packages cool may limit the hazard. Cooling may be necessary for a considerable time.

4.12.10 For incidents under deck, the best course of firefighting will usually be to batten down the hatch, exclude all ventilation and operate the fixed firefighting installation.

4.12.11 Self-contained breathing apparatus should be worn at any time when seafarers are likely to be exposed to smoke or fumes.

4.12.12 For certain substances that are highly reactive with water, the use of dry powder or CO₂ is recommended. If there is no alternative to the use of water, the likelihood of reaction with the substance should be recognised.

4.12.13 Where an EmS advises against the use of foam, an alternative such as dry powder or CO₂ should be used.

4.12.14 The general firefighting recommendations for a number of dangerous goods suggest that they should be jettisoned if there is a likelihood of their involvement in a fire. Where full or nearly full container loads or other units are concerned, this may be impractical, in which case everything possible should be done to prevent the spread of fire to those containers. If, despite preventive measures, fire seems likely to affect these containers, it should be borne in mind that the contents may burn with explosive violence and personnel should be withdrawn accordingly.

Blank page

CHAPTER 5

FIRE PRECAUTIONS

5.1 General

5.1.1 The prevention of fire on board ship is of utmost importance. Sections 5.2 to 5.6 of this chapter outline some important organisational measures that can be taken to reduce the risk of fire. Advice to seafarers is included in Chapter 4, Emergency drills and procedures.

5.1.2 Chapter 4 deals with action in the event of fire and other emergency procedures.

5.2 Smoking

5.2.1 Conspicuous warning notices should be displayed in any part of the ship where smoking is forbidden (permanently or temporarily) and observance of them should be strictly enforced. Ashtrays or other suitable containers should be provided and used at designated places. E-cigarettes are a source of ignition and should not be used in hazardous areas.

5.3 Electrical and other fittings

5.3.1 All electrical appliances should be firmly secured and served by permanent connections whenever possible. All electric wiring should be well maintained and kept clean and dry. The rated load capacity of the wires and fuses should never be exceeded.

5.3.2 Flexible leads should be as short as practicable and so arranged as to prevent their being chafed or cut in service.

5.3.3 Makeshift plugs, sockets and fuses should not be used.

5.3.4 Circuits should not be overloaded because this causes the wires to overheat, destroying insulation and thus resulting in a possible short-circuit, which could start a fire. Notices should be displayed warning that approval should be obtained from a responsible officer to connect any personal electrical appliances to the ship's supply.

5.3.5 All portable electrical appliances, lights, etc. should have insulation readings taken before use, and should be isolated from the mains after use.

5.3.6 Electrical equipment used in any cargo area should be of an approved design.

5.3.7 It is important that all fixed electric heaters are fitted with suitable guards securely attached to the heater and that the guards are maintained in position at all times. Drying clothing on or above the heaters should not be permitted and suitably designed equipment should be supplied, or areas designated.

5.3.8 When using drying cabinets or similar appliances, the ventilation apertures should not be obscured by overfilling of the drying space. Any screens or fine mesh covers around the ventilation apertures should be regularly inspected and cleaned, so that they do not become blocked by accumulated fluff from clothing.

5.3.9 The use of portable heaters should be avoided wherever possible. However, if they are required while the ship is in port (as temporary heating during repairs or as additional heating during inclement weather), a protective sheet of a non-combustible material should be provided to stand them on to protect wooden floors or bulkheads, carpets or linoleum. Portable heaters should be provided with suitable guards and should not be positioned close to furniture or other fittings. These heaters should never be used for drying clothes, etc. unless that is the purpose for which they were designed, e.g. a heated towel rail.

5.3.10 Personal portable space-heating appliances of any sort should not be used at sea.

5.3.11 The installation of electric heaters should always be carried out in accordance with the relevant regulations and instructions or guidance supplied by the manufacturer.

5.4 Spontaneous combustion

5.4.1 Dirty or damp waste, rags, sawdust and other rubbish – especially if contaminated with oil – may generate heat spontaneously, which may be sufficient to ignite flammable mixtures or set the rubbish itself on fire. Such waste and rubbish should therefore be properly stored until it can be safely disposed of.

5.4.2 Materials in ships' stores, including linen, blankets and similar absorbent materials, are also liable to ignite by spontaneous combustion if damp or contaminated by oil. Strict vigilance, careful stowage and suitable ventilation are necessary to guard against such a possibility. If such materials become damp, they should be dried before being stowed away. If oil has soaked into them, they should be cleaned and dried, or destroyed. They should not be stowed in close proximity to oil or paints, or on or near to steam pipes.

5.5 Machinery spaces

5.5.1 All personnel should be made fully aware of the precautions necessary to prevent fire in machinery spaces – in particular, the maintenance of clean conditions, the prevention of oil leakage and the removal of all combustible materials from vulnerable positions. (See Chapter 20, Work on machinery and power systems, for more information.)

5.5.2 Suitable metal containers with an integral cover should be provided for the storage of cotton waste, cleaning rags or similar materials after use. Such containers should be emptied at frequent intervals and the contents disposed of safely.

5.5.3 Wood, paints, solvents, oil and other flammable materials should not be stored in boiler rooms or machinery spaces including steering gear compartments.

MSC.1/Circ.1321

5.5.4 Inspection and maintenance of insulated hot surfaces and equipment with associated piping and fittings that handle flammable liquids should be routinely carried out. In particular, attention should be paid to the following (and, where appropriate, manufacturer's instructions adhered to):

- flexible hose installations;
- bellows;
- filters and strainers;
- thermal insulation;
- gauge piping; and
- pipe fittings.

More information and guidance is published in IMO, MSC.1/Circ.1321.

5.6 Galleys

5.6.1 Galleys and pantries present particular fire risks (see Chapter 23, Food preparation and handling in the catering department). Care should be taken in particular to avoid overheating or spilling fat or oil and to ensure that burners or heating plates are shut off when cooking is finished. Extractor flues and ranges, etc. should always be kept clean.

5.6.2 The means to smother fat or cooking oil fires, such as a fire blanket, should be readily available close to stoves. Remote cut-offs and stops should be conspicuously marked and galley staff should be thoroughly familiar with their location and operation.

Blank page

CHAPTER 6

SECURITY ON BOARD

6.1 Introduction

6.1.1 Shipboard security is essential in reducing the risks of theft, terrorism, armed robbery, stowaways, piracy and drug smuggling. The International Ship and Port Facility Security (ISPS) Code, published by the International Maritime Organization (IMO), was introduced on 1 July 2004 and provides a framework through which ships and port facilities can cooperate to detect and deter acts that threaten security in the maritime transport sector.

6.2 Ship security plans

EC 725/2004

6.2.1 The ISPS Code and its parent requirement (SOLAS Chapter XI-2) apply to certain types of ships engaged on international voyages. These are:

- passenger ships, including high-speed passenger craft;
- cargo ships, including high-speed craft, of 500 gross tonnage and upwards; and
- mobile offshore drilling units (MODUs).

Regulation EC 725/2004 extends the scope of compliance to include:

- domestic 'Class A' passenger ships (domestic ships which travel more than 20 miles from a place of refuge);
- domestic ships required to comply by an EU member state's risk assessment – for the UK, this covers ships certified to carry more than 250 passengers, and tankers; and
- port facilities serving any of the types of ships detailed above.

6.2.2 The ISPS Code requires a ship security plan (SSP), which is kept up to date and relevant to the particular ship. The SSP covers, amongst other criteria, the procedures required at different security levels:

- to prevent unauthorised weapons, dangerous substances and devices intended for use against persons, ships or ports from being taken aboard;
- to prevent unauthorised access to the ship;
- to respond to security threats or breaches of security;
- for the use of the ship security alert system; and
- to maintain the ship's security infrastructure.

6.2.3 The SSP is protected from unauthorised access or disclosure, which may include restricted distribution of copies amongst ship's crew. The SSP shall specify the requirement for training drills and exercises. The SSP shall also include the requirement for facilitating shore leave for ship's personnel or personnel changes, as well as access of visitors to the ship.

6.2.4 The ship security officer (SSO) is responsible for enhancing security awareness and vigilance on board and ensuring that adequate training is provided to those with security responsibilities.

6.3 Security levels

ISPS Code A/7

6.3.1 Governments are required to set one of three security levels for ships flying their flag, and for ports under the government's control. The ship is required to maintain the security level set by the government of the port it is entering unless the ship's government requires a higher security level to be maintained. For UK and Red Ensign ships, the Maritime Security and Resilience division of the Department for Transport is responsible for setting the security levels and communicates changes direct to company security officers (CSOs) for onward transmission to ships.

6.4 Precautions

6.4.1 In port, appropriate security precautions should be taken, including ensuring adequate lighting at night and that a gangway watch is maintained at all times.

6.4.2 At sea, appropriate precautions should be taken including, where appropriate, posting additional lookouts and security rounds. Lookouts should be alert to the approach of lit or unlit craft. Consideration should be given to the use of night-vision equipment.

6.4.3 At anchor, appropriate precautions should be taken including adequate lighting at night and security patrols on deck. Lookouts should be alert to the approach of lit or unlit craft. Consideration should be given to the use of night-vision equipment.

6.5 Terrorism

6.5.1 To discourage persons trying to smuggle weapons and explosives on board, an appropriate sign should be displayed at all access points stating that 'All items brought on board this ship are liable to be searched.'

6.6 Stowaways

6.6.1 If there is any likelihood of stowaways, a thorough search of the vessel should be made before departure. This should include all accommodation, engine room, store rooms, accessible below-deck spaces, lifeboats and any other spaces where a person could hide.

6.7 Piracy and armed robbery

6.7.1 In areas of high risk of piracy or armed robbery, additional precautions should be taken in accordance with best management practice. This should include measures to prevent persons boarding the vessel at sea, at anchor or in port.

6.7.2 Ships are advised to maintain anti-piracy watches while transiting areas of high risk and report all piratical and armed robbery incidents, including suspicious movements of boats and skiffs, to the 24-hour-manned IMB Piracy Reporting Centre (IMB PRC) in Kuala Lumpur, Malaysia.

6.8 Smuggling

6.8.1 Personnel should be alert to the possibility that persons may attempt to smuggle drugs or other contraband on board the vessel, and should be made aware of the procedures to follow if such items are found or the activity is suspected.

6.9 Personnel joining and leaving the vessel

6.9.1 Information on personal safety is available through the Foreign and Commonwealth Office (FCO), British embassies, high commissions and consulates in the area concerned. Advice should be strictly adhered to.

Blank page

CHAPTER 7

HEALTH SURVEILLANCE

*S.I. 1997/2962
(as amended)*

7.1 Duty of employers

7.1.1 Employers must provide seafarers with such health surveillance as is appropriate, taking into account the risks to their health and safety that have been identified by the risk assessment undertaken in accordance with the regulations.

7.2 Purpose of health surveillance

7.2.1 Health surveillance is a means of identifying early signs of ill health caused by occupational hazards so that action can be taken to protect individuals at an early stage from further harm.

7.2.2 A degree of health surveillance is available through monitoring results from the seafarer's medicals. The introduction of health and sickness reporting procedures, associated records and analysis will help identify any likely risks at an early stage; for example:

- Where a seafarer's exposure to a hazard is approaching the agreed limit, the seafarer should be removed from exposure before any harm is done.
- If symptoms of minor ailments (e.g. skin rash) are detected, action should be taken to prevent them from becoming major health problems.

Where no specific risks are identified through the risk assessments this may not be appropriate. However, it is the responsibility of the employer to assess the need for additional health surveillance measures.

7.2.3 In addition, the results of health surveillance can provide a means of:

- checking the effectiveness of health control measures;
- providing feedback on the accuracy of health risk assessment; and
- identifying and protecting individuals who are at increased risk.

7.2.4 Health surveillance is not a substitute for measures to control risks to health and safety. Control measures should always be the first consideration to reduce risk. Nor is it the same as medical examinations, which are intended to assess fitness to work, e.g. pre-employment, sickness resumption, or periodic examinations. However, it is recommended that, wherever possible, health surveillance should be

conducted at pre-employment assessment, where a baseline reference can be usefully established.

7.3 Application

S.I. 2007/3100

S.I. 2007/3075

S.I. 2007/3077

S.I. 2010/323

S.I. 2010/330

S.I. 2010/332

S.I. 2010/2984

S.I. 2010/2987

*MGN 409(M+F),
Annex 3*

7.3.1 Health surveillance should be introduced where risk assessment identifies that:

- a particular work activity may cause ill health;
- an identifiable disease or adverse health condition is related to the work;
- recognised testing methods are available for early detection of an occupational disease or condition, e.g. audiometry or skin inspection (where dermatitis is a hazard);
- there is a reasonable likelihood that a disease or condition may occur in relation to particular working conditions; and
- surveillance is likely to further the protection of seafarers' health.

7.3.2 All employed seafarers are entitled to the health surveillance that is appropriate for the work activities they are involved in. Examples of circumstances in which it may be useful include:

- exposure to hazardous substances such as chemicals or biological agents carcinogens and mutagens;
- working with vibrating tools;
- exposure to high levels of noise;
- use of substances known to cause dermatitis (e.g. solvents); and
- exposure to certain dusts (e.g. asbestos).

7.4 What to do

7.4.1 The health surveillance cycle

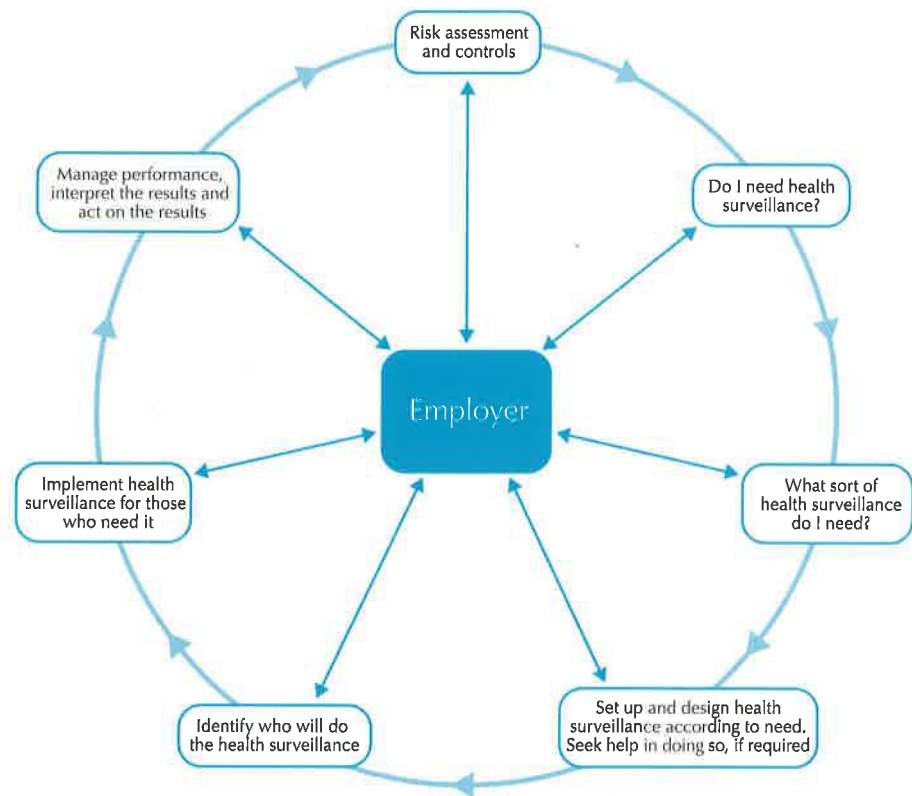

7.4.2 Once it is decided that health surveillance is appropriate, a record must be maintained for all seafarers under health surveillance while they remain exposed to the hazard(s) in-question.

7.4.3 It is recommended that health surveillance records should be retained in a suitable form for up to 40 years from the date of last entry as there could be a long period between exposure and onset of ill health. The record should be kept in a suitable format so that it can be linked with other information, e.g. with any workplace exposure measurements. (See the Health and Safety Executive (HSE) website for information on record keeping.)

7.4.4 Health surveillance may involve one or more actions as applicable. These are:

- inspection of readily detectable conditions (e.g. skin damage) by a person acting within the limits of their training and experience;
- enquiries about symptoms;
- hearing checks (audiometry);
- medical examinations or company health checks; and
- testing blood or urine samples.

7.4.5 The frequency of such checks should be determined either on the basis of suitable general guidance (e.g. skin inspection for skin damage) or on the advice of a qualified occupational health practitioner.

7.4.6 Where medical surveillance is required, and it is necessary to take samples or record other personal information, it is essential that confidentiality is maintained in respect of individual health records containing clinical information.

7.5 Seafarers

7.5.1 Health surveillance that is developed with the involvement and cooperation of seafarers is more effective as they are involved in health and safety decision making for their workplace. The seafarers concerned should be given an explanation of the purpose of health surveillance and the opportunity to comment on the proposed frequency of such health surveillance procedures, either directly or through their safety representatives.

7.6 Managing health surveillance

7.6.1 When the health surveillance arrangements are in place, it will be necessary to act on the results and make sure that the findings are reported to management. The information in the results can be used to revise any risk assessments and controls.

Once the results are known, the employer should:

- act to protect those who are found to have health issues and organise further assessment;
- consider the options for dealing with seafarers with ill health who may no longer be fit to be exposed, or those who have restrictions placed on exposure – which may require referral to an occupational health practitioner; and
- take action on results where potential workplace problems are found.

(See the HSE website for information on managing health surveillance.)

7.7 Additional practical guidance on health surveillance for exposure to biological agents

7.7.1 The doctor and/or the authority responsible for the health surveillance of seafarers exposed to biological agents must be familiar with the exposure conditions or circumstances of each seafarer.

7.7.2 Health surveillance must be carried out in accordance with the principles and practices of occupational medicine; it must include at least the following measures:

- Records of the seafarer's medical and occupational history.
- A personalised assessment of the seafarer's state of health.
- Where appropriate, biological monitoring, as well as detection of early and reversible effects.

Further tests may be decided on for each seafarer when they are the subject of health surveillance, in the light of the most recent knowledge available to occupational medicine.

*S.I. 2010/323 and
MGN 408(M+F)*

7.7.3 In cases where a seafarer has been exposed to biological agents identified in group 3 or higher, a record must be kept for at least ten years following the end of exposure. In cases where the effect of a disease may be long term, records may require to be kept for 40 years. Medical advice from the health surveillance provider should be sought on the appropriate retention period.

7.8 Reporting of occupational diseases

*S.I. 2014/1616,
S.I. 1997/2962*

7.8.1 The Merchant Shipping (Maritime Labour Convention) (Health and Safety) (Amendment) Regulations 2014 require employers to report any occupational disease to the Maritime and Coastguard Agency (MCA) once a written report from a doctor has been received.

*MSN 1850(M),
MSF 4159*

7.8.2 Guidance on the reporting of occupational diseases has been published in merchant shipping notice MSN 1850(M). This also contains a table that lists the reportable diseases. Form MSF 4159, for the recording of occupational diseases, has also been published and is available to download from www.gov.uk.

7.8.3 The completed form should be submitted to the MCA, which will retain the report for statistical purposes and, if necessary, take appropriate action in relation to any particular occupational disease identified – such as issuing safety alerts or further guidance.

Blank page

CHAPTER 8

PERSONAL PROTECTIVE EQUIPMENT

*S.I. 1999/2205,
MSN 1870(M+F),
Reg. 5*

8.1 Introduction

8.1.1 Risks to the health and safety of seafarers must be identified and assessed. It will often not be possible to remove all risks, but attention should be given to control measures that will make the working environment and working methods as safe as reasonably practicable.

8.1.2 Personal protective equipment (PPE) must be used only when risks cannot be avoided or reduced to an acceptable level by safe working practices. This is because PPE does nothing to reduce the hazard and can only protect the person wearing it, leaving others vulnerable.

8.1.3 Controls should be chosen taking into account various factors. In order of effectiveness these are:

- elimination;
- substitution by something less hazardous and risky;
- enclosure (enclose the hazard in a way that eliminates or controls the risk);
- guarding/segregation of people;
- safe system of work that reduces the risk to an acceptable level;
- written procedures that are known and understood by those affected;
- reviewing the blend of technical and procedural control;
- adequate supervision;
- identification of training needs;
- information/instruction (signs, hand-outs); and
- PPE (last resort) – cannot be controlled by any other means.

8.1.4 It should be noted that the use of PPE may in itself cause a hazard, e.g. through reduced field of vision, loss of dexterity or agility.

8.2 General requirements

Reg. 6(1)

8.2.1 The Company must ensure that seafarers are provided with suitable PPE where it is needed.

Reg. 6(3)

8.2.2 As a general rule, PPE should be supplied at no cost to the seafarer. The exception to this is where it is not exclusive to the workplace, and so seafarers may be required to contribute to the cost, or when seafarers wish to have equipment that exceeds the minimum standards required by legislation (e.g. a more attractive design).

8.2.3 The Company should assess the equipment required to ensure that it is suitable and effective for the task in question, and meets the appropriate standards of design and manufacture.

MSN 1870(M+F),
Reg. 6(2)

8.2.4 Suitable equipment should:

- be appropriate for the risks involved, and the task being performed, without itself leading to any significant increased risk;
- fit the seafarer correctly after any necessary adjustment;
- take account of ergonomic requirements and the seafarer's state of health; and
- be compatible with any other equipment that the seafarer has to use at the same time, so that it continues to be effective against the risk.

8.2.5 Details of PPE are listed in a merchant shipping notice (MSN), including the full title of each relevant standard. The appropriate PPE of the required standard must be supplied for seafarers doing the tasks listed in the M notice. However, this should not be considered an exhaustive list and PPE must be supplied wherever risk assessment indicates that there is a risk to health and safety from a work process that cannot be adequately controlled by other means, but which can be alleviated by the provision of such clothing or equipment.

Reg. 8

8.2.6 The Company must also ensure that PPE is regularly checked and maintained or serviced. Records should be maintained of servicing and any repair required and carried out.

Reg. 9

8.2.7 All seafarers required to use protective equipment must be properly instructed and trained in its use. This should include being advised of its limitations and why it is needed. A record should be kept of who has received training.

Reg. 8(4)

8.2.8 Defective or ineffective protective equipment provides no defence. It is therefore essential that the correct items of equipment are selected and that they are properly maintained at all times. The manufacturer's instructions should be kept safe with the relevant apparatus

and, if necessary, referred to before use and when maintenance is carried out. PPE should be kept clean and should be disinfected as and when necessary for health reasons.

Reg. 8(4)

8.2.9 A competent person should inspect each item of protective equipment at regular intervals and in all cases before and after use. All inspections should be recorded. Equipment should always be properly stowed in a safe place after use.

8.3 Seafarer duties

Reg. 10

8.3.1 Seafarers must wear the protective equipment or clothing supplied when they are carrying out a task for which it is provided, and follow appropriate instructions for use.

8.3.2 PPE should always be checked by the wearer each time before use. Seafarers should comply with the training they have received in the use of protective items, and follow the manufacturer's instructions for use.

8.4 Types of equipment

8.4.1 Overalls, gloves and suitable footwear are the proper working dress for most work about ship but these may not give adequate protection against particular hazards in particular jobs. Specific recommendations for the use of special PPE will be found in relevant chapters of this Code, but there will be other occasions when the need for such special protection will be identified by the risk assessment carried out by the officer in charge at that particular time.

8.4.2 PPE must always be selected according to the hazard being faced and the kind of work being undertaken, in accordance with the findings of the risk assessment.

8.4.3 PPE can be classified as follows:

Type	Examples
Head protection	Safety helmets, bump caps, hair protection
Hearing protection	Earmuffs, earplugs
Face and eye protection	Goggles and spectacles, facial shields
Respiratory protective equipment	Dust masks, respirators, breathing apparatus
Hand and foot protection	Gloves, safety boots and shoes
Body protection	Safety suits, safety belts, harnesses, aprons, high-visibility clothing
Protection against drowning	Lif jackets, buoyancy aids and lifebuoys
Protection against hypothermia	Immersion suits and anti-exposure suits

8.5 Head protection

Safety helmets

8.5.1 Safety helmets are most commonly provided as protection against falling objects. They can also protect against crushing or a sideways blow, and chemical splashes.

8.5.2 Since the hazards may vary, it will be appreciated that no one type of helmet would be ideal as protection in every case. Design details are normally decided by the manufacturer whose primary consideration will be compliance with an appropriate standard (see section 8.2.5). The standard selected should reflect the findings of the risk assessment.

8.5.3 The shell of a helmet should be of one-piece seamless construction designed to resist impact. The harness or suspension, when properly adjusted, forms a cradle for supporting the protector on the wearer's head. The crown straps help absorb the force of impact. They are designed to permit a clearance of approximately 25 mm between the shell and the skull of the wearer. The harness or suspension should be properly adjusted before a helmet is worn. Safety equipment should be used in accordance with manufacturer's instructions.

Bump caps

8.5.4 A bump cap is an ordinary cap with a hard penetration-resistant shell. They are useful as protection against bruising and abrasion when working in confined spaces such as a main engine crankcase or a double bottom tank. They do not, however, afford the same protection as safety helmets and are intended only to protect against minor knocks.

Hairnets and safety caps

8.5.5 Seafarers working on or near to moving machinery should always be aware of the possibility of their hair becoming entangled in the machinery. Long hair should always be covered by a hairnet or safety cap when working with or near moving machinery.

8.6 Hearing protection

S.I. 2007/3075

MGN 352(M+F)

8.6.1 All seafarers exposed to high levels of noise (e.g. in machinery spaces) should wear ear protection of a type recommended as suitable for the particular circumstances. Protectors are of three types: earplugs, disposable or permanent, and earmuffs. For further information see the *Code of Practice for Controlling Risks due to Noise on Ships and Merchant Shipping and Fishing Vessels (Noise at Work) Regulations 2007*.

Earplugs

8.6.2 The simplest form of ear protection is the earplug. This type, however, has the disadvantage of limited capability of noise level reduction.

8.6.3 Earplugs made from rubber or plastic also have only a limited effect, in that extremes of high or low frequency make the plug vibrate in the ear canal causing a consequential loss in protection. It may be difficult to keep re-usable earplugs clean on a ship and disposable earplugs are recommended. Earplugs should never be used by anyone with ear trouble, without medical advice.



General fitting instructions for disposable earplugs

Earplugs offer excellent protection against noise, but only if they are fitted correctly.

Make sure that your hands are clean before fitting any earplugs.



Hold the earplug between your thumb and index finger. Roll and compress the whole earplug, use your other hand to reach over your head and pull up and back on your outer ear. This straightens the ear canal and makes way for a tight and snug fit.



Insert an earplug in each ear canal and hold for 20–30 seconds. This enables the earplug to expand and fill your ear canal.



Test the fit of your earplugs

In a noisy environment, and with your earplugs inserted, cup both your hands over your ears and release. You should not notice any significant difference in the noise level. If the noise level appears to reduce when your hands are cupped over your ears, your earplugs are probably not correctly fitted. Remove and refit your earplugs.



Always remove your earplugs slowly. Twist them to break the seal. Removing your earplugs too quickly could damage your eardrum.

Always read the manufacturer's instructions and get guidance on how to wear earplugs correctly.

Do not reuse disposable earplugs.

Do not share your earplugs.

Protect it or lose it

Earmuffs

8.6.4 In general, earmuffs provide a more effective form of hearing protection. They consist of a pair of rigid cups designed to completely envelope the ears, fitted with soft sealing rings to fit closely against the head around the ears. The ear cups are connected by a spring-loaded headband (or neck band), which ensures that the sound seals around the ears are maintained. Different types are available, and provision should be made according to the circumstances of use and expert advice.



General fitting instructions for earmuff ear protection

Earmuffs offer excellent protection against noise but only if the cups are fitted and adjusted correctly.

Your ears must be completely enclosed within the ear cups.



Adjust the cups up or down to ensure that the headband fits securely on the crown of your head. The best performance is obtained when the cup cushions make a tight seal against your head.

Test the fit of your earmuffs

In a noisy environment, place the palms of your hands on both cups, push the cup cushions towards your head then release the cups. You should not notice any significant difference in the noise level. If the noise level appears to reduce when you press the cups, your earmuffs are probably not correctly fitted.



Check the cup cushion regularly for wear and tear. Clean them regularly with a damp hygienic cloth or wipe. If the cup cushions become hard, damaged or deteriorate they must be replaced immediately.

Always read the manufacturer's instructions and get guidance on how to wear earmuffs correctly.

Do not share your earmuffs.

Protect it or lose it

8.7 Face and eye protection

8.7.1 The main causes of eye injury are:

- infra-red rays (gas welding);
- ultra-violet rays (electric welding);
- exposure to chemicals; or
- exposure to flying particles and foreign bodies.

Face and eye protectors are available in a wide variety, designed to international standard specifications, to protect against these different types of hazard (see section 8.2.5).

8.7.2 Ordinary prescription (corrective) spectacles, unless manufactured to a safety standard, do not afford protection. Certain box-type goggles are designed so that they can be worn over ordinary spectacles.

8.8 Respiratory protective equipment

8.8.1 Respiratory protective equipment is essential for protection when work has to be done in conditions of irritating, dangerous or poisonous dust, fumes or gases. There are two main types of equipment, which perform different functions:

- A respirator filters the air before it is inhaled.
- Breathing apparatus supplies air or oxygen from an uncontaminated source.

8.8.2 Advice on selection, use and maintenance of the equipment is contained in the relevant standard. This should be available to all those concerned with the use of respiratory protective equipment on board ship (see section 8.2.5).

8.8.3 It is most important that the face piece of respirators and breathing apparatus is fitted correctly to avoid leakage. The wearing of spectacles, unless adequately designed for that purpose, or having a beard is likely to adversely affect the face seal. This is a particularly important consideration in emergency situations.

Respirators

8.8.4 The respirator selected must be of a type designed to protect against the hazards being met.

8.8.5 The dust respirator gives protection against dusts and aerosol sprays but not against gases. There are many types of dust respirator available but they are generally of the ori-nasal type, i.e. half-masks covering the nose and mouth.

8.8.6 Many types of light, simple face mask are also available and are extremely useful for protecting against dust nuisance and non-toxic sprays, but should never be used in place of proper protection against harmful dusts or sprays. Types of respirator include the following:

- The positive pressure-powered dust respirator incorporates a battery-powered blower unit, connected by a tube to the face mask to create a positive pressure in the face piece. This makes breathing easier and reduces face-seal leakage.
- The cartridge-type of respirator consists of a full face-piece or half-mask connected to a replaceable cartridge containing absorbent or adsorbent material and a particulate filter. It is designed to provide protection against low concentrations of certain relatively non-toxic gases and vapours.

- The canister-type of respirator incorporates a full face-piece connected to an absorbent or adsorbent material contained in a replaceable canister carried in a sling on the back or side of the wearer. This type gives considerably more protection than the cartridge type.

8.8.7 The filters, canisters and cartridges incorporated in respirators are designed to provide protection against certain specified dusts or gases. Different types are available to provide protection against different hazards and it is therefore important that the appropriate type is selected for the particular circumstances or conditions being encountered. It must be remembered, however, that they have a limited effective life and must be replaced or renewed at intervals in accordance with manufacturers' instructions.

8.8.8 **Respirators provide no protection against an oxygen-deficient atmosphere.** They are designed to purify the air of specific contaminants and they do not supply any further air. They should never be used to provide protection in dangerous (enclosed) spaces such as tanks, cofferdams, double bottoms or other similar spaces against dangerous fumes, gases or vapours. Only breathing apparatus (self-contained or airline) is capable of giving protection in such circumstances.

Personal gas monitors

8.8.9 Personal gas monitors should be carried when working in dangerous spaces. The type of monitor should be determined by a competent person within a safe system of work, and will depend on the circumstances and knowledge of possible contaminants.

8.8.10 Where there is a potential risk of flammable or explosive atmospheres, monitors specifically designed to measure for these will be required. All such monitors should be specifically suited for use in potentially flammable or explosive atmospheres.

8.8.11 Monitors should be in good working order, and calibrated and tested either in accordance with the manufacturer's recommendations, or in line with another schedule identified from the findings of the risk assessment.

8.8.12 Personal gas monitors must only be used in conjunction with the procedures set out in Chapter 15 when entering a dangerous space.

Breathing apparatus

8.8.13 The type of breathing apparatus to be used when entering a space that is known to be, or suspected of being deficient in oxygen, or containing toxic gas or vapours, is given in section 15.13.

8.8.14 Breathing apparatus should not be used underwater unless the equipment is suitable for the purpose, and then only in an emergency.

Resuscitators

8.8.15 It is recommended that resuscitators of an appropriate kind should be provided when any person may be required to enter a dangerous space (see Chapter 15, Entering dangerous (enclosed) spaces).

8.9 Hand and foot protection

Gloves

8.9.1 The exact type of glove selected will depend on the kind of work being undertaken or the particular substance being handled and, in these cases, expert advice should be followed. The following are general rules:

- Leather gloves should generally be used when handling rough or sharp objects.
- Heat-resistant gloves should be used when handling hot objects.
- Rubber, synthetic or PVC gloves are generally best for handling acids, alkalis, various types of oils, solvents and chemicals in general.

Footwear

8.9.2 Foot injuries most often result from the wearing of unsuitable footwear (e.g. sandals, plimsolls and flip-flops) rather than from failure to wear safety shoes and boots. It is nevertheless strongly advisable that all personnel whilst at work on board ship wear appropriate safety footwear.

8.9.3 Injuries are commonly caused by impact, penetration through the sole, slipping, heat and crushing. Safety footwear is available that is designed to protect against these or other specific hazards identified in the risk assessment, manufactured to various standards appropriate to the particular danger involved (see section 8.2.5).

8.10 Protection from falls

8.10.1 All personnel who are working at height (i.e. in any position from which there is a risk of falling) should wear a safety harness (or belt with shock absorber) attached to a lifeline. If a vessel is shipping frequent seas, nobody should be required to work on deck unless absolutely necessary. However, where this is unavoidable, persons on deck should wear a harness and, where practicable, should be secured by lifeline as a protection from falls, and from being washed overboard, or against the ship's structure. (See also Chapter 17, Work at height.)

8.10.2 Inertial clamp devices allow more freedom in movement.

A five-point harness

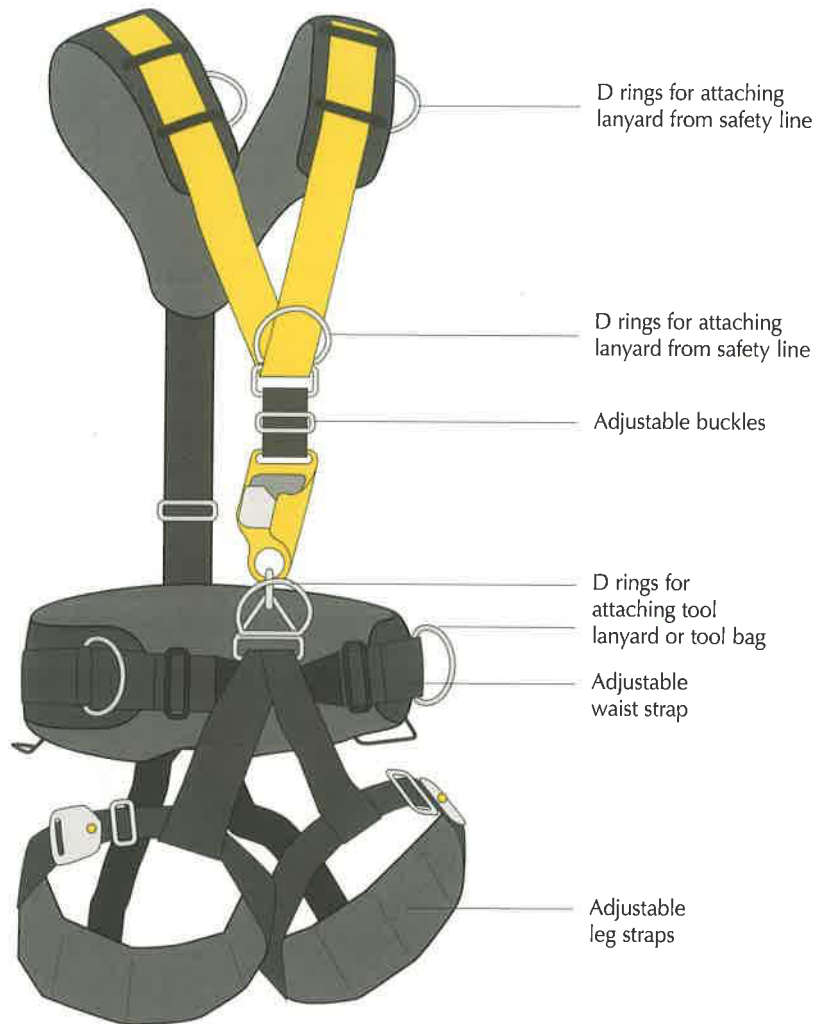

8.11 Body protection

8.11.1 Special outer clothing may be needed for protection when personnel are exposed to particular contaminating or corrosive substances. This clothing should be kept for the particular purpose and dealt with as directed in the relevant sections of this Code.

8.11.2 High-visibility clothing should be worn when it is important to be seen to be safe, e.g. during loading and unloading operations.

8.12 Protection against drowning

8.12.1 Where work is being carried out overside or in an exposed position where there is a reasonably foreseeable risk of falling or being washed overboard, or where work is being carried out in or from a ship's boat, a lifebuoy with sufficient line should be provided. In addition and, as appropriate, a working lifejacket, a personal flotation device or a buoyancy aid should be worn. Where necessary, personnel should

be provided with thermal protective clothing to reduce the risks of cold shock.

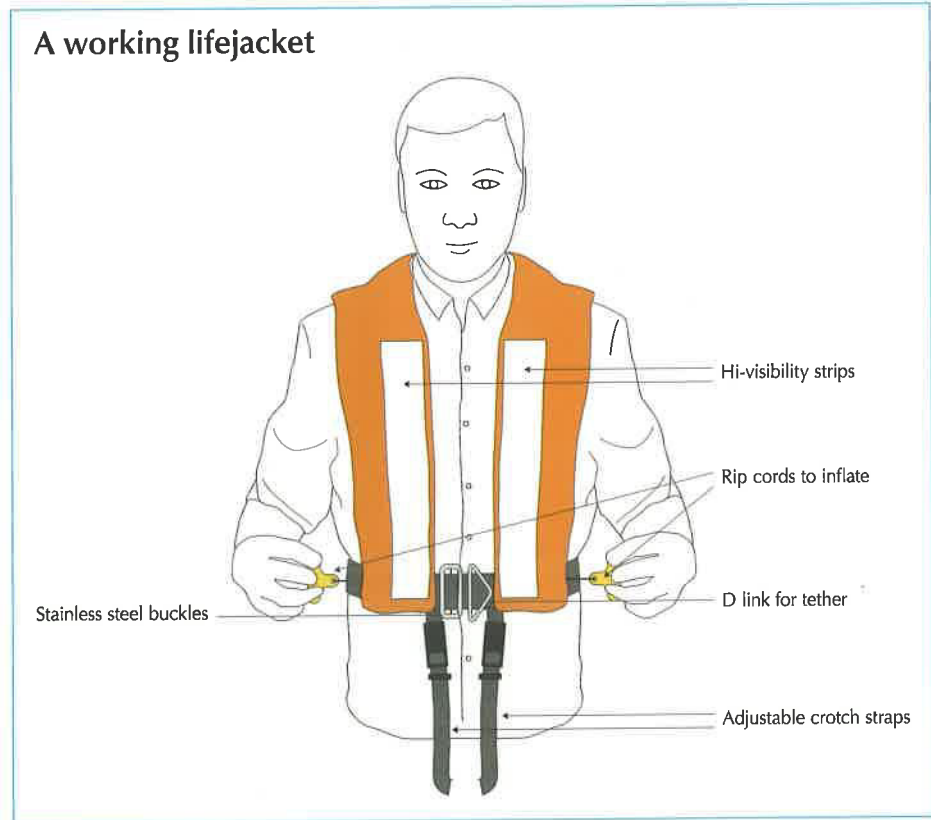

CHAPTER 9

SAFETY SIGNS AND THEIR USE

*S.I. 2001/3444
and MGN
556(M+F)*

9.1 Introduction

9.1.1 Any safety signs permanently erected on board UK ships for the purpose of giving health and safety information or instruction shall comply with the regulations and merchant shipping notices (MSNs). Other national and international standards providing an equivalent level of safety will be accepted.

9.1.2 Safety signs that include hazard warnings should be used to indicate hazards and obstructions or control measures to be taken where the hazard or obstruction cannot be removed. Particular attention should be paid on passenger ships to hazards that may be familiar to seafarers but not to passengers.

9.1.3 Where a language other than English is the working language of the ship, any text used in conjunction with a sign should also be displayed in that language.

9.2 Duty to display signs

9.2.1 The Company should ensure that safety signs are displayed where appropriate. If the Company is not in a position to provide signs (e.g. where the fittings of the ship are not within their control), they should ensure that signs are in place before allowing any relevant work to take place. The Company should also ensure that the system of signs in use is clearly understood.

9.3 Role of the seafarer

9.3.1 All seafarers should ensure that they understand the meaning of signs and any colour-coding system in use on their ship and follow the relevant safety procedures.

9.3.2 Those aware of any deficiency in their colour vision should tell their supervisor, so that adequate provision can be made where necessary.

9.4 Signs and notices

9.4.1 The international standards for safety signs are explained in the following paragraphs. Colours and symbols, when used appropriately,

can provide information and warnings of hazards that can be understood by anyone, regardless of what language they speak. Annex 9.1 gives the types of sign that conform to international systems, where they exist, and European-wide standards.

9.4.2 Symbols relating to life-saving appliances are mandatory and are governed by international standards. Those relating to fire control plans are recommended international standards.

9.4.3 Permanent signs are used to:

- give prohibitions, warnings and mandatory requirements;
- mark emergency escape routes;
- identify first-aid facilities; and
- show the location of firefighting equipment.

9.4.4 Red signs mean:

- stop doing something or don't do it (prohibition);
- stop/shut down or evacuate; or
- mark the location and type of firefighting equipment.

9.4.5 Signs of prohibition are based on a red circular band with a red diagonal bar and white backing. The symbol for the prohibited action is shown in black behind the red diagonal bar, e.g. 'No smoking', with a cigarette depicted.

9.4.6 A sign indicating firefighting equipment is a red square or rectangle, with information given in words or by a symbol in white. Alternatively, an International Maritime Organization (IMO) sign is a square or rectangle, with information given in words or by a symbol in red.

9.4.7 Yellow signs are advisory and mean be careful or take precautions. Warning signs are based on a yellow triangle with a black border. The symbol for the hazard is shown in black, e.g. poisoning risk with black skull and crossbones on a yellow background.

9.4.8 Blue signs are mandatory and mean take a specific action. Mandatory signs are based on a blue disc. The symbol for the precaution to be taken is shown in white, e.g. 'Goggles to be worn', with a person's head with goggles depicted. If, exceptionally, no suitable symbol is available, appropriate wording may be used instead, e.g. 'Keep clear'.

*IMO Resolution
A.654(16)*

9.4.9 Green signs mean emergency escape or a first-aid sign. The sign is a green square or rectangle, with safety information shown by words or a symbol in white. For example, a white arrow on a green background points to an emergency exit.

9.4.10 If more information is needed to make clear the meaning of any symbols used in a safety sign or notice, then a supplementary sign with text only may appear below the sign, e.g. 'Not drinking water'.

The supplementary sign should be oblong or square and either:

- white with text in black; or
- the same background colour as the safety colour used on the sign it is supplementing, with the text in the relevant contrasting colour.

9.5 Occasional signs

9.5.1 Illuminated signs, acoustic signals, hand signals and spoken signals may also be used for temporary hazards or circumstances.

9.5.2 Illuminated signs and acoustic signals must be tested regularly to ensure that they are working. Acoustic signals should comply with the IMO Code on Alerts and Indicators, 2009.

9.5.3 The internationally understood hand signals for the use of lifting appliances are given in Annex 19.1.

9.5.4 Spoken signals should comply with the IMO Standard Marine Communication Phrases (SMCP), 2002. This is particularly important when communicating with another ship or with shore-side workers where English is not the official language.

9.6 Electrical wiring

9.6.1 The cores of electrical cables should be readily identifiable throughout their length by colours or numbers. Although various standards (British, other national or international) exist for colour coding of cores, the colours specified in the standards differ. The colours found on any ship will, therefore, depend on the country of building or manufacture of the cables. Care should therefore always be taken to make a positive identification of cable duty, and colours should be used primarily as a means of conductor tracing.

9.6.2 Particular care is required when connecting plugs to domestic equipment that has been brought on to a ship, because a wrong connection could prove fatal. UK equipment should be supplied with cable to the EU standard (i.e. brown for 'live', blue for 'neutral' and

yellow/green for 'earth') but older equipment and that purchased in other countries may have different colours.

9.7 Gas cylinders

BS EN 1089-3:2011

9.7.1 There are a variety of standards for the marking of gas cylinders in use globally. It is essential that seafarers are made aware of the standard in use on board.

9.7.2 Each cylinder should be clearly marked with the name of the gas and its chemical formula or symbol. Under British standards, the cylinder body should be coloured according to the contents with, where necessary, a secondary colour band painted around the neck of the cylinder to denote the particular hazards of the gas (flammability, toxicity, etc.). Examples of such colour coding on gas cylinders commonly used on board ship are as follows:

Example of a typical gas cylinder label

A **Danger**

- May cause or intensify fire: oxidiser
- Contains gas under pressure, may explode if heated
- Store away from combustible materials
- Keep valves and fittings free from grease and oil
- In case of fire: stop leak if safe to do so
- Store in a well-ventilated place

B **OXYGEN**

C **COMPRESSED GAS 2**

C **OXIDISING AGENT 5.1**

D EC 231-956-9

D 230 bar at 15°C

E Gross weight 80Kg

F **SIZE W**

Refer to SDS for further information

I Do not remove label

G **IN EMERGENCY**

UK

☎ 0123 456 789

Cylinder Road

Essex

AB12 C23

IRELAND

☎ 0123 456 789

Cylinder Road

Dublin

Ireland

AB12 C23















H

UN1072 OXYGEN, COMPRESSED

A Hazards and precautions, **B** Name of product, **C** Hazard diamond(s), **D** Filled pressure, **E** Gross weight, **F** Cylinder size, **G** Contact information, **H** Unique cylinder serial number, **I** Additional company information

Gas cylinder colours

Colours and codes are for guidance and illustrative purposes only. **Please always read the label.**

Name of gas	Chemical formula or symbol	Old colour before 2010	New colour of the cylinder after 2010
Oxygen	O ₂	Black 	Pure white RAL 9010 
Carbon dioxide	CO ₂	Black 	Dusty grey RAL 7037 
Compressed air	None – mixed gases	French grey 	Grey on cylinder and green on shoulder 
Nitrogen	N ₂	French grey 	Jet black RAL 9005 
Acetylene	C ₂ H ₂	Maroon colour BS 541 (Black red RAL 3007) 	Maroon colour BS 541 (Black red RAL 3007) 
Propane	C ₃ H ₈	Signal red RAL 3001 	Signal red RAL 3001 
Butane	C ₄ H ₁₀	Not specified	Not specified
Helium	He	Brown 	Olive brown RAL 8008 

Note: The cylinders of refrigerant gases are not allocated specified ground or band colours under the British Standard Specification.

BS EN ISO
407:2004

9.7.3 Medical gas cylinders carried on board should similarly be marked in accordance with the relevant British Standard Specification or equivalent (see Appendix 3, Standards and specifications referred to in this Code). The name of the gas or gas mixture contained in the cylinder should be shown on a label affixed to it. The chemical symbol of the gas should be given on the shoulder of the cylinder. The cylinder should also be colour coded according to the contents, as shown in the following examples:

Medical gas cylinders

The body of the cylinder is to be coloured white (RAL 9010).

Name of gas	Chemical formula or symbol	Old colour before 2010	New colour on the shoulder of the cylinder after 2010
Oxygen	O ₂	White on shoulder and black on cylinder body 	Pure white RAL 9010 on both shoulder and cylinder 
Medical oxygen	O ₂	White on shoulder and black on cylinder body 	Pure white RAL 9010 on both shoulder and cylinder 
Medical nitrous oxide	N ₂ O ₂	Blue 	Pure white (RAL 9010) on cylinder. Blue RAL 5010 on shoulder 
Compressed air (for breathing apparatus)	None (mixed gases)	French grey BS381 680 	Pure white (RAL 9010) on cylinder. Jet black (RAL 9005) on shoulder 

9.8 Pipelines

BS ISO
14726:2008,
BS 4800:2011

9.8.1 The following colour-coding system is recommended for adoption for the main common pipeline services of UK-registered ships:

Pipe contents	Basic identification colour	BS colour reference BS 4800	Colour code band	BS colour reference BS 4800
Water (fresh)	Green	12D 45	Blue	18E 53
Water (salt)	Green	12D 45	None	
Water (fire extinguishing)	Green	12D 45	Safety red	04E 53
Compressed air	Light blue	20E 51	None	
Steam	Silver grey	10A 03	None	
Oil (diesel fuel)	Brown	06C 39	White	
Oil (furnace fuel)	Brown	06C 39	None	
Oil (lubricating)	Brown	06C 39	Emerald green	14E 53

9.8.2 The basic identification colour should be applied on the pipe either along its whole length or as a colour band at regular intervals on the pipe. The colour should similarly be applied at junctions, both sides of valves, service appliances, bulkheads, etc., or at any other place where identification might be necessary. Valves on pipelines used for firefighting should be painted red.

9.8.3 Where applicable, the colour code banding should be in approximately 100 mm widths at regular intervals along the length of the pipe on the basic identification colour or painted between two basic identification colour bands each a width of about 150 mm as shown in the following examples:

Pipe contents	Basic colour (150 mm approx.)	Colour code (100 mm approx.)	Basic colour (150 mm approx.)
Water (fresh)	Green	Blue	Green
Water (fire extinguishing)	Green	Safety red	Green
Diesel fuel	Brown	White	Brown

9.8.4 Care should be taken to ensure when replacing or repainting pipes, valves, etc. that the correct colour is used.

9.8.5 When it is necessary to know the direction of the flow of the fluid, this should be indicated by an arrow situated in the proximity of the basic identification colour and painted white or black in order to contrast clearly with that colour.

9.8.6 Such a system as recommended above would be useful, for instance, in tracing a run of pipes but should not be relied upon as a positive identification of the contents of the pipe; a check should always be made before opening the pipe and precautions taken against the contingency that the content is other than that expected.

9.8.7 Other pipeline systems on ships, such as cargo pipelines, may be colour coded in a similar fashion but no specific recommendations are made here because a comprehensive system to cover the needs of all types of ship would require so wide a range of colours that contrasts would be small and easily obscured by fading or dirt.

9.8.8 Colour coding of pipelines may vary from ship to ship and seafarers moving from one ship to another should check with a competent officer what the colours mean on each particular vessel.

9.9 Portable fire extinguishers

*MSN 1665(M) and
BS EN 3-10:2009*

9.9.1 Portable fire extinguishers must comply with the relevant British or European Standard or an equivalent alternative standard.

9.9.2 Fire extinguishers manufactured since May 1997 must comply with the new Standard, BS EN 3. The body of the extinguisher is red, with a zone of colour of between 5% and 10% of the external area to identify the extinguishing agent. Manufacturers have complied with this by printing the operating instructions in the appropriate colour.

BS 7863:2009,
BS 5423:1987

9.9.3 It is possible to increase the visibility of the extinguishers by highlighting the area around each one with the appropriate colour coding (as in section 9.9.4). No additional colour should be added to the extinguishers, because this may invalidate the kitemark.

9.9.4 BS 5423 applied to fire extinguishers manufactured before May 1997. The colour of these extinguishers should not conflict with the following recommended systems of colour coding by medium (BS 7863).

Water	Signal red
Foam	Pale cream
Powder (all types)	French blue
Carbon dioxide	Black

The area so coded should be large enough to be readily apparent. Where the coding does not cover the whole surface of the extinguisher it is recommended that the remaining area should be either:

- predominantly signal red; or
- self-coloured (i.e. natural) metal.

9.9.5 Where there is a mixture of extinguishers of both standards on a ship, as far as possible they should be positioned so as to avoid confusion.

Annex 9.1 Safety signs in accordance with the Merchant Shipping and Fishing Vessels (Safety Signs and Signals) Regulations 2001 and MGN 556(M+F)

Part 1 – prohibitory signs

Symbol Meaning
Prohibition – do not do



Examples:



No smoking



Smoking and naked flames forbidden



No access for pedestrians



Do not extinguish with water



Not drinkable



No access for unauthorised persons



No access for industrial vehicles



Do not touch

Additional useful prohibition signs



Do not remove electrical earth



Do not operate



Do not use mobile telephones/
Turn off mobile telephones



Unauthorized persons not to use this machine



Do not oil or clean machine whilst in motion



Unauthorized persons may not change grinding wheels

Part 2 – warning signs

Symbol Meaning
Warning – danger



Examples:



Flammable material or high temperature¹



Explosive material



Toxic material



Corrosive material



Radioactive material



Overhead load



Industrial vehicles



Danger: electricity



General danger²



Laser beam



Oxidant material



Non-ionising radiation



Strong magnetic field



Obstacles



Drop



Biological risk³



Low temperature

1 To be used in the absence of a specific sign for high temperature.

2 This warning sign shall not be used to warn about hazardous chemical substances or mixtures, except for stores containing a number of hazardous substances or mixtures (section 5 of Annex III of MGN 556(M+F)).

3 Pictogram laid down in Council Directive 90/679/EEC of 26 November 1990 on the protection of workers from the risks related to exposure to biological agents at work (Seventh individual Directive within the meaning of article 16(1) of Directive 89/391/EEC) OJ. No 1,374, 31.12.1990, p. 1.

Additional useful warning signs



Slip or slippery surface



Suffocation (asphyxiation), deficiency in oxygen



Breakthrough hazard



Danger of entrapment



Bump or low deckhead



CAUTION
Moving vehicles



Optical radiation



Glass hazard, broken glass



Machinery starts automatically



Hot surface



High temperature



Danger
Very hot water



DANGER
Hot surface



Danger
Explosive atmosphere



CAUTION
Moving vehicles



Danger
Compressed gas



Acetylene



Oxygen



DANGER
You are entering a CO₂ protected area



Caution
Harmful fumes



Danger
High noise levels

Part 3 – mandatory signs

Symbol Meaning
Mandatory – must do



Examples:



Eye protection must be worn



Safety helmet must be worn



Ear protection must be worn



Respiratory equipment must be worn



Safety boots must be worn



Safety gloves must be worn



Safety overalls must be worn



Face protection must be worn



Safety harness must be worn



Pedestrians must use this route



General mandatory sign
(to be accompanied where necessary by another sign)

Additional useful mandatory signs



High visibility clothing must be worn



Now wash your hands



Keep clear



Part 4 – emergency escape, first-aid signs and safe condition

Symbol	Meaning
	Emergency escape, first aid and safe condition – the safe way

Examples:

Emergency exit/escape route signs

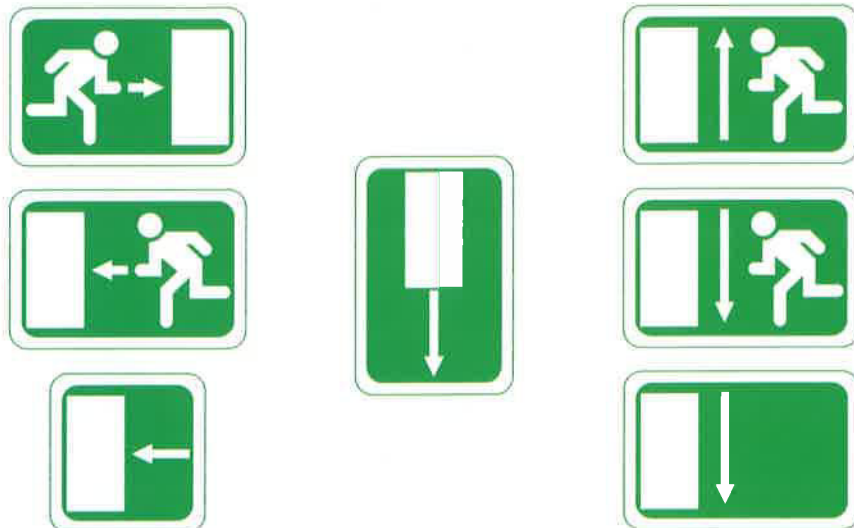

Supplementary information signs

(i) This way

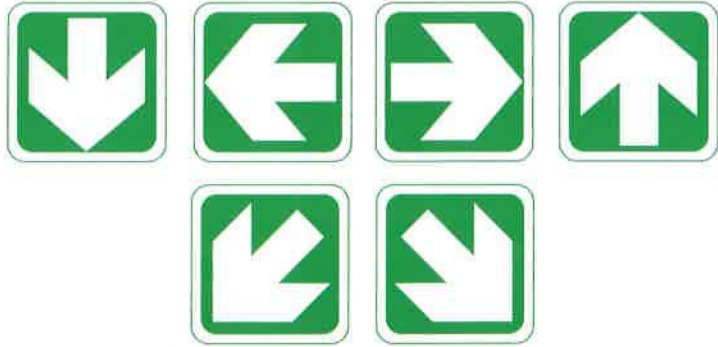

(ii) First-aid signs



First-aid post

Stretcher

Safety shower

Eyewash

(iii) Safe condition signs



Emergency telephone for first aid or escape



Emergency stop for machinery

Additional useful safe condition sign

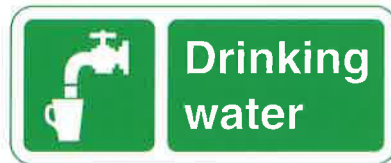

Drinking water

Part 5 – firefighting symbols

Symbol Meaning
 Fire equipment – location or use of fire equipment



Examples:



Fire hose



Ladder



Fire extinguisher



Emergency fire telephone

Supplementary information signs

(i) This way

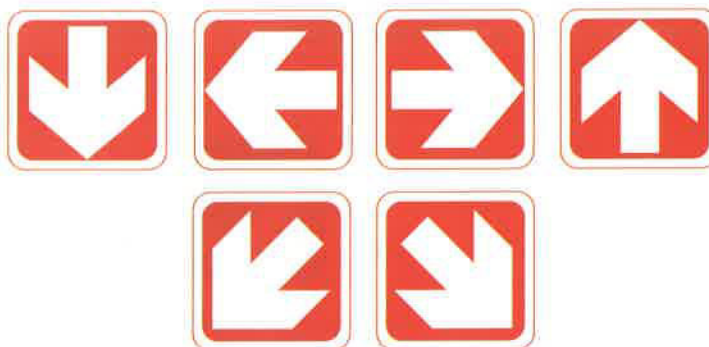

Fire alarm



Fire extinguisher

Additional useful fire equipment signs



Fire extinguishers

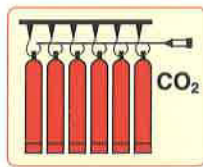

CO₂ fixed installation



FM 200 fixed installation



NOVEC 1230 fixed installation

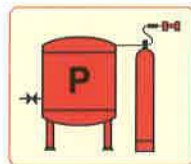

Dry powder fixed installation



Blank page

CHAPTER 10

MANUAL HANDLING

10.1 Introduction

10.1.1 This chapter identifies some areas that may require attention in respect of manual handling. In all cases, a risk assessment should be used as the basis for appropriate control measures, which should be put in place to protect those who may be affected.

10.1.2 The assessment should take full account not only of the characteristics of the load and the physical effort required but also of the working environment (e.g. ship movement, confined space, high or low temperature, physical obstacles such as steps or gangways) and any other relevant factors (e.g. the age and health of the person, the frequency and duration of the work). A fuller list of factors to be considered is given in Annex 10.1.

10.2 General

10.2.1 The term 'manual handling' is used to describe any operation that includes any transporting or supporting of a load, lifting, putting down, pushing, pulling, carrying or moving by hand or bodily force. This guidance is generally concerned with preventing musculoskeletal injury.

10.2.2 There may, of course, be other hazards to those handling loads (e.g. from leakage of a hazardous substance from a package that is being moved) but these are dealt with in other relevant chapters.

10.2.3 Musculoskeletal injuries can occur as a result of accident, poor organisation or an unsatisfactory working method.

10.3 Role of the Company

10.3.1 So far as reasonably practicable, the Company is required to take appropriate measures or provide the means to:

Assess the risk of injury from any hazardous manual-handling activity.

Avoid the need for any hazardous manual-handling operations, which may cause injury to seafarers, e.g. by re-organisation of the work, or automating or mechanising the operation.

Reduce the risk of injury from hazardous manual handling.

Provide information on the weight of each load and, if appropriate, which side is heaviest.

*S.I. 1998/2857,
Reg. 5 and MGN
90(M+F)*

Train seafarers in appropriate manual-handling techniques. Before instructing personnel to lift or carry by hand, where there is a risk of injury, Companies should consider whether alternative means of doing the same job would reduce this risk.

10.3.2 Means of reducing the risk of injury may include:

- re-organisation of the workplace (to enable seafarers to maintain good posture while lifting or carrying); and
- taking account of an individual's capabilities when allocating tasks.

10.3.3 There are often limitations in a ship on the improvements that can be made but the Company should ensure that, as far as reasonably practicable, risks have been minimised.

10.3.4 Instruction for personnel should involve experienced and properly trained seafarers demonstrating best practice, especially to new recruits.

Reg. 6

Advice to seafarers

You should make full and proper use of any system of work provided by the Company.

You should:

- use any mechanical aids provided;
- follow appropriate systems of work laid down for your health and safety;
- take sensible precautions to ensure that you are aware of any risk of injury from a load before picking it up;
- cooperate on all health and safety matters;
- inform your line manager if you identify hazardous handling activities;
- plan the lift – where is the load to be placed?
- consider whether you need any help with the load. Some loads require two or more people to lift safely. Are there appropriate handling aids you could use? For a long lift, such as deck to shoulder height, consider resting the load midway in order to change grip;



- assess the load to be lifted, taking account of any information provided (see guidance textbox in Annex 10.1);
- look for sharp edges, protruding nails or splinters, surfaces that are greasy or otherwise difficult to grip and for any other features that may prove awkward or dangerous, e.g. sacks of ship's stores may be difficult to get off the deck;
- ensure that the deck or area over which the load is to be moved is free from obstructions, especially in narrow accesses, and is not slippery; and
- check the final stowage location to ensure that it is clear and suitable for the load.

10.4 Good manual-handing techniques



10.4.1 The diagram illustrates some important points in lifting techniques:

- The load and the lift should be assessed before lifting.
- A firm, stable and balanced stance should be taken, close to the load with the feet apart but not too wide, with one leg slightly forward to maintain balance, so that the lift is as straight as possible.
- At the start of the lift and when lifting from a low level or deck, a crouching position should be adopted, with knees and hips bent, whilst maintaining the natural curve of the back to ensure that the legs do the work. It helps to tuck in the chin while gripping the load and then raise the chin as the lift begins.
- The load should be gripped with the whole of the hand, not fingers only. If there is insufficient room under a heavy load to do this, a piece of wood should be put underneath first. A hook grip is less tiring than keeping the fingers straight. If the grip needs to be varied as the lift proceeds, this should be done as smoothly as possible.
- The load should be lifted by straightening the legs, keeping it close to the body. The heaviest side should be kept closest to the trunk. The shoulders should be kept level and facing the same direction as the hips. Turning by moving the feet is better than twisting and lifting at the same time. Look ahead, not down at the load, once it is held securely.

10.4.2 When two or more people are handling a load, it is preferable that they should be of similar stature. The actions of lifting, lowering and carrying should, as far as possible, be carried out in unison to prevent strain and any tendency for either person to overbalance.



10.4.3 The procedure for putting a load down is the reverse of that for lifting: the legs should do the work of lowering with knees bent, back straight and the load close to the body. Care should be taken not to trap fingers. The load should not be put down in a position where it is unstable. If precise positioning is necessary, the load should be put down first and then slid into the desired position.

10.4.4 A load should always be carried in such a way that it does not obscure vision, so allowing any obstruction to be seen.

10.4.5 The risk of injury may be reduced if lifting can be replaced by controlled pushing or pulling. For example, it may be possible to slide the load or roll it along. However, uncontrolled sliding or rolling, particularly of large or heavy loads, may introduce fresh risks of injury. Particular care must be taken if:

- stooping, stretching or twisting is likely;
- hands on the load are not between waist and shoulder height;
- the deck area is insecure or slippery;
- force is applied at an angle to the body;
- the load makes sudden or unexpected movements; and
- if the vessel is rolling or pitching.

10.4.6 For pulling and pushing, a secure footing should be ensured, and hands applied to the load at a height between waist and shoulder wherever possible. Wheels on barrows and trolleys should run smoothly, and the supervisor or safety officer should be informed if the equipment provided is not suitable, or is in poor condition.



A further option, where other safety considerations allow, is to push with the worker's back against the load, using the strong leg muscles to exert the force.

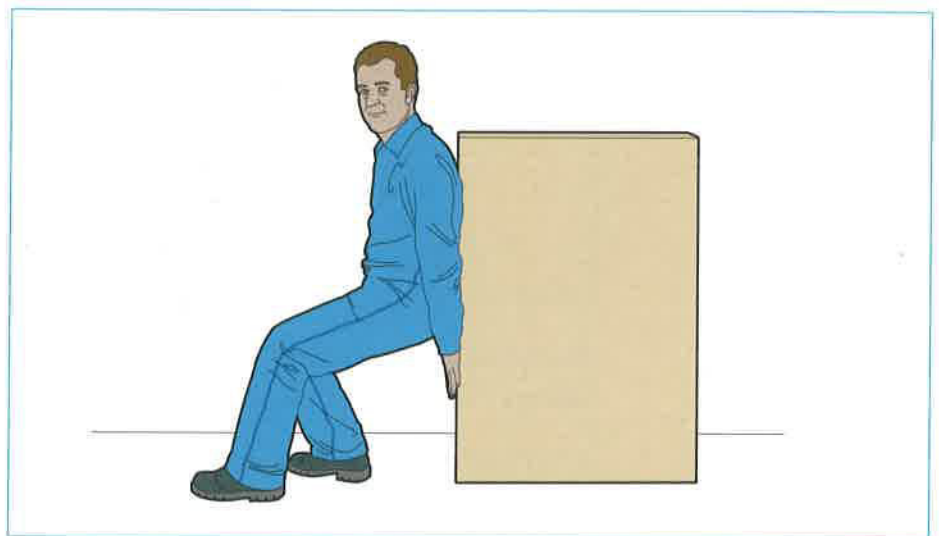

10.4.7 Even a gentle uphill slope dramatically increases the force needed to push an object, so help may be necessary when moving a load up a slope or ramp. Care should be taken with unbraked trolleys and sack trucks on a moving/rolling deck, because sudden changes in the angle of deck and direction of the slope may result in loss of control and injury. If a trolley becomes loose, do not try to stop it by standing in its way, but get behind it and try to act as a brake.

10.4.8 Care must be taken with the laying out of heavy mooring ropes and wire ropes/hawsers. This duty requires a good technique initially in lifting the heavy eye of the rope, followed by a good pulling technique. Crews should make sure that there are enough people available to do the task safely.

10.4.9 When moving a load, such as a barrel or drum, rolling the load may be a safer operation than lifting it. Care must still be taken, and the use of a trolley should be considered for heavy or large barrels or drums.



10.4.10 Suitable shoes or boots should be worn for the job. Protective toecaps help to guard toes from crushing if the load slips.

10.4.11 Clothing that does not catch in the load and gives some body protection should be worn.

10.4.12 Where the work is very strenuous (e.g. due to load weight, repetitive effort over a period or environmental factors, such as a confined space or an extreme of temperature), rest should be taken at suitable intervals to allow muscles, heart and lungs to recover. Fatigue makes accidents more likely on work of this type.

10.4.13 Whenever possible, manual lifting and carrying should be organised in such a way that each person has some control over their own rate of work.

Annex 10.1 Factors to be considered

The following are examples of the factors to which the Company should have regard, and the questions they should consider when making an assessment of manual-handling operations or providing instruction for personnel.

Plain text gives the general factors and questions to be considered in the risk assessment carried out under the regulations. *Additional specific factors that may be found on board ship are included for guidance (text in italics).*

Factors	Questions
1. The tasks	<p>Do they involve:</p> <ul style="list-style-type: none"> • activity that is too strenuous? • holding or manipulating loads at distance from trunk? • unsatisfactory or unstable bodily movement or posture, especially: <ul style="list-style-type: none"> – twisting the trunk? – stooping? – reaching upward? • excessive movement of loads, especially: <ul style="list-style-type: none"> – excessive lifting or lowering distances? – excessive carrying distances? • risk of sudden movement of loads? • frequent or prolonged physical effort, particularly affecting the spine? • insufficient rest or recovery periods? • a rate of work imposed by a process? • <i>climbing up or down stairs?</i> • <i>handling while seated?</i> • <i>use of special equipment?</i> • <i>team handling?</i>

Factors	Questions
2. The loads	<p>Are they:</p> <ul style="list-style-type: none"> • heavy? • bulky or unwieldy, or difficult to grasp? • unstable or with contents that are likely to shift? • likely, because of the contours and/or consistency, to injure workers, particularly if the individual collides with someone or something? • <i>wet, slippery, very cold or hot and, therefore, difficult to hold?</i> • <i>sharp?</i> • <i>potentially damaging/dangerous if dropped?</i>
3. The working environment	<ul style="list-style-type: none"> • Are there space constraints preventing the handling of loads at a safe height or with good posture? • Is there an uneven, slippery or unstable deck surface? • Are there variations in level of deck surfaces (e.g. door sills) or work surfaces? • Are there extremes of temperature or humidity? • <i>Has account been taken of the sea state, wind speed and the unpredictable movement of the vessel?</i> • <i>Are there steps, stairs or ladders or self-closing doors to be negotiated?</i> • <i>Is the area adequately lit?</i> • <i>Is movement or posture hindered by personal protective equipment or by clothing?</i>

Factors	Questions
4. Individual capability	<p>Is the individual:</p> <ul style="list-style-type: none"> • physically unsuited to carrying out the task, either because of the nature of the task or because of a need to protect an individual from a danger that specifically affects them? <ul style="list-style-type: none"> – <i>i.e. does the job require unusual strength, height, etc.?</i> – <i>is there a hazard to those who might reasonably be considered unsuited to the task?</i> – <i>does it pose a risk to those who are pregnant or have a health problem?</i> • wearing unsuitable clothing, footwear or other personal effects? • inadequately experienced or trained? • inadequately equipped?

The diagram below shows guidelines for safe weights for manual handling.

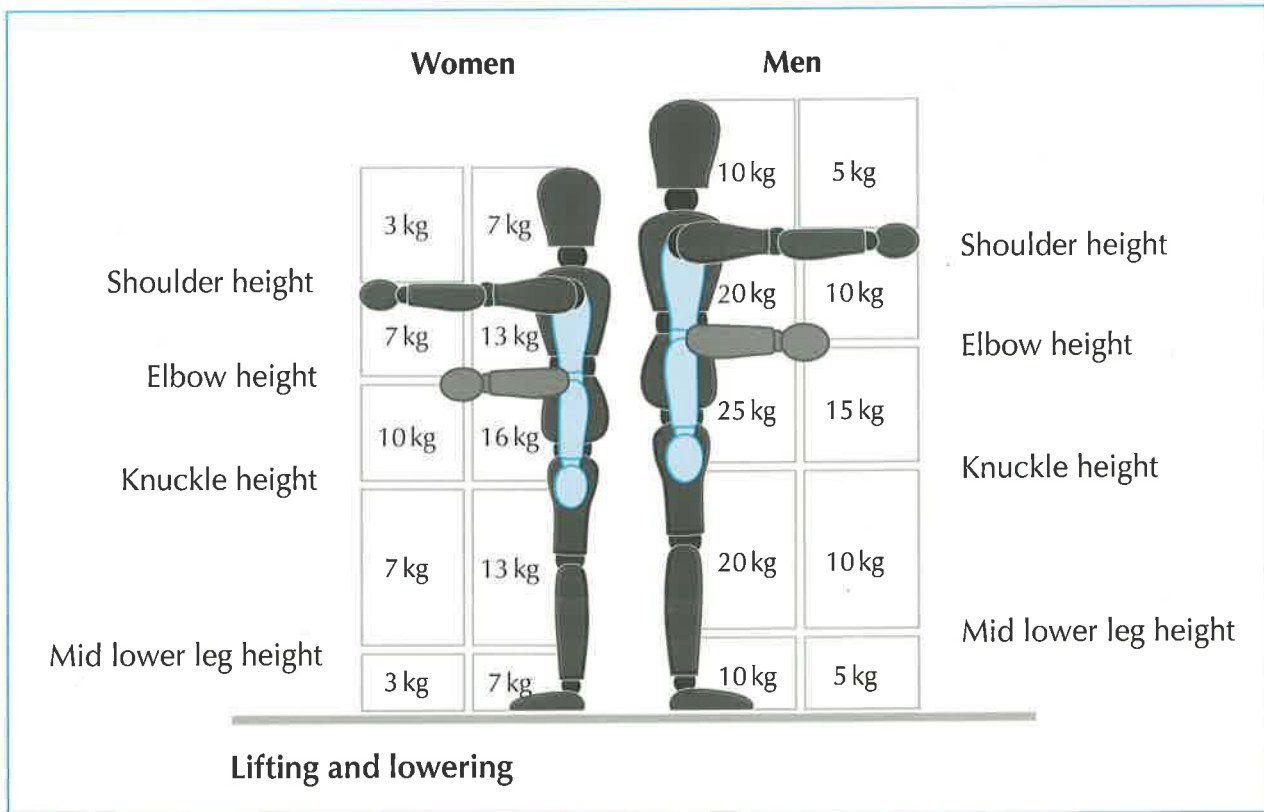

The guidelines for safe weight vary depending on the capacity of the individual and also the position in which the weight is held. Subject to risk assessment, lighter weights may be safely lifted with arms extended or at high or low levels. The diagram above gives guidelines, which will reduce the risk of harm. The safe weight is reduced if the seafarer has to twist or carry out the lift repeatedly (say more than 30 times per hour). Consideration should also be given to the movement of the vessel during the risk assessment for the task. If the load moves through more than one box, use the lower weight as the safe weight.

CHAPTER 11

SAFE MOVEMENT ON BOARD SHIP

11.1 Introduction

*S.I. 1997/2962,
MGN 532(M)*

11.1.1 Providing conditions for safe movement on board ship is considered to be an integral part of ensuring a safe working environment on board, as required by the Merchant Shipping and Fishing Vessels (Health and Safety at Work) Regulations 1997, regulation 5(2)(e). Following the principles and guidance in this chapter will generally be considered to demonstrate compliance with the duty to ensure a safe working environment on board ship. Where different measures are taken to provide a safe movement, these alternative measures must provide at least an equivalent level of safety in the operating conditions at the time.

11.1.2 The purpose of this chapter is to set out appropriate standards to ensure that anyone can move safely to any place on the ship to which a person may be expected to go.

11.1.3 Places on the ship where persons may be expected to go include accommodation areas as well as normal places of work and passenger areas. 'Persons' in this context include seafarers and other persons working on board, passengers, dock workers and other visitors to the ship on business, but exclude persons who have no right to be on the ship.

11.2 General principles

*S.I. 2001/3444,
MGN 556(M+F)*

11.2.1 All deck surfaces used for transit about the ship and all passageways, walkways and stairs should be properly maintained and kept free from substances liable to cause a person to slip or fall.

11.2.2 For areas used for transit, loading or unloading of cargo or for other work processes, an adequate level of lighting should be provided. Further guidance is in section 11.5 and in Annex 11.2 to this chapter.

11.2.3 The Company, employer and master are also responsible for ensuring that any permanent safety signs providing information for those moving around the ship comply with the regulations and merchant shipping notice.

11.2.4 Any opening, open hatchway or dangerous edge into, through or over which a person may fall should be fitted with secure guards or fencing of adequate design and construction. Advice on guardrails

and safety fencing is given in section 11.6. These requirements do not apply where the opening is a permanent access way or where work is in progress that could not be carried out with the guards in place.

11.2.5 The ship's powered vehicles (including mobile lifting plant) may only be driven by a competent, authorised person who is able to ensure that they are used safely. Such vehicles must be properly maintained.

11.3 Drainage

11.3.1 Decks that need to be washed down frequently, or are liable to become wet and slippery, should be provided with an effective means of draining water away. Apart from any open deck, these places include the galley, the ship's laundry and the washing and toilet accommodation.

11.3.2 Drains and scuppers should be regularly inspected and properly maintained.

11.3.3 Where drainage is by way of channels in the deck, these should be suitably covered.

11.3.4 Duck boards, where used, should be soundly constructed and designed and maintained so as to prevent accidental tripping.

11.4 Transit areas

11.4.1 Where necessary for safety, walkways on decks should be clearly marked, e.g. by painted lines or other means. Where a normal transit area becomes unsafe to use for any reason, the area should be closed until it can be made safe again.

11.4.2 Transit areas should where practicable have slip-resistant surfaces. Where an area is made slippery by snow, ice or water, sand or some other suitable substance should be spread over the area. Spillages of oil or grease, etc. should be cleaned up as soon as possible.

11.4.3 When rough weather is expected, lifelines should be rigged securely across open decks.

11.4.4 Gratings in the deck should be properly maintained and kept closed when access to the space below is not required.

11.4.5 Permanent fittings that may cause hazards to movement (e.g. pipes, single steps, framing, door arches, and top and bottom rungs of ladders) should be made conspicuous by the use of contrasting coloured, marking, lighting or signage. Temporary obstacles can also be hazardous and, if they are to be there for some time, they should be marked by appropriate warning signs.

11.4.6 When at sea, any gear or equipment stowed to the side of a passageway or walkway should be securely fixed or lashed against the movement of the ship.

11.4.7 Litter and loose objects (e.g. tools) should not be left lying around. Wires and ropes should be stowed and coiled so as to minimise obstruction.

11.4.8 Particular attention should be given to areas to which shore-based workers and passengers have access, especially on deck, as they will be less familiar with possible hazards.

11.4.9 When deck cargo is being lashed and secured, special measures may be needed to ensure safe access to the top of, and across, the cargo.

11.5 Lighting

11.5.1 The level of lighting should be such as to enable obvious damage to, or leakage from, packages to be seen. When there is a need to read labels, or container plates, or to distinguish colours, the level of lighting should be adequate to allow this or other means of illumination should be provided.

11.5.2 Lighting should be reasonably constant and arranged to minimise glare and dazzle, the formation of deep shadows and sharp contrasts in the level of illumination between one area and another.

11.5.3 Where visibility is poor (e.g. due to fog, clouds of dust, or steam), which could lead to an increase in the risks of accidents occurring, the level of lighting should be increased above the recommended minimum.

11.5.4 Lighting facilities should be properly maintained. Broken or defective lights should be reported to the responsible person and repaired as soon as practicable.

11.5.5 Before leaving an illuminated area or space, a check should be made that there are no other persons remaining within that space before switching off or removing lights.

11.5.6 Unattended openings in the deck should either be kept illuminated or be properly or safely closed before lights are switched off.

11.5.7 When portable or temporary lights are in use, the light supports and leads should be arranged, secured or covered so as to prevent a person tripping, being hit by moving fittings or walking into cables or supports. Any slack in the leads should be stowed so as not to create a trip hazard. The leads should be kept clear of possible causes of damage (e.g. running gear, moving parts of machinery, equipment and loads).

If they pass through doorways, the doors should be secured open. Leads should not pass through doors in watertight bulkheads or fire door openings when the ship is at sea. Portable lights should never be lowered or suspended by their leads.

11.5.8 Where portable or temporary lighting has to be used, fittings and leads should be suitable and safe for the intended usage. To avoid risks of electric shock from mains voltage, the portable lamps used in damp or humid conditions should be of low voltage, preferably 12 volts, or other suitable precautions should be taken.

11.6 Guarding of openings

11.6.1 Hatchways that are open for handling cargo or stores, through which persons may fall or on which they may trip, should be closed as soon as work stops, except during short interruptions or where they cannot be closed without prejudice to safety or mechanical efficiency because of the heel or trim of the ship.

11.6.2 The guardrails or fencing should have no sharp edges and should be properly maintained. Where necessary, locking devices and suitable stops or toe-boards should be provided. Each course of rails should be kept substantially horizontal and taut throughout their length.

11.6.3 Guardrails or fencing should consist of an upper rail at a height of 1 metre and an intermediate rail at a height of 0.5 metres. The rails may consist of taut wire or taut chain.

11.6.4 Where the opening is a permanent access way, or where work is in progress which could not be carried out with the guards in place, guards do not have to be fitted during short interruptions in the work (e.g. for meals), although warning signs should be displayed where the opening is a risk to other persons.

11.7 Watertight doors

MGN 35(M+F)

11.7.1 Watertight doors can inflict serious injury if their operation is not carried out correctly. Therefore, all seafarers who would have occasion to use any watertight doors should be instructed in their safe operation. Seafarers who have not been instructed in their use should not under any circumstance operate them until such training has been given. Training records should be kept. Doors should always be operated in accordance with local instructions.

11.7.2 Class D watertight doors must always be kept closed during navigation.

11.7.3 Class C watertight doors may be opened during navigation to permit the passage of passengers or crew. The door must be immediately closed when transit through the door is complete.

11.7.4 Class B watertight doors may be opened during navigation when necessary for work in the immediate vicinity of the door. The door must be immediately closed when that work is finished.

11.7.5 Class A watertight doors are permitted by the administration to remain open during navigation. In all cases, if a watertight door is found closed it may automatically close after being opened manually so extra care must be taken.

11.7.6 Any class of watertight door may be put into bridge operation mode. If opened locally under these circumstances the door will reclose automatically with a force sufficient to crush anyone in its path as soon as the local control has been released. It is safest to treat doors as if they are in this mode at all times.

11.7.7 The local controls are positioned on each side of the door so that a person passing through may open the door and then reach to the other control to keep the door in the open position until transit is complete. As both hands are required to operate the controls, no seafarer should attempt to carry any load through the door unassisted. If it is necessary to carry anything through a watertight door in these circumstances another person should be employed to assist.

11.7.8 Notices clearly stating the method of operation of the local controls should be prominently displayed on both sides of each watertight door.

11.7.9 No one should attempt to pass through a watertight door when it is closing and/or the warning bell is sounding. In all cases, seafarers should wait until the door is fully open before attempting to pass through it.

11.7.10 Any watertight door found in a closed position must be returned to that position after opening.

MGN 35(M+F)

11.7.11 When reading this advice, note should be made of the content of marine guidance note MGN 35(M+F), Accidents when using power-operated watertight doors.

11.8 Stairways, ladders and portable ladders

11.8.1 Stairways on ships are often set at a steep angle. Handrails should always be used, and where possible tools, etc. carried in a belt rather than in the hand, to leave hands free.

11.8.2 All ship's ladders should be of good construction and sound material, strong enough for the purpose for which they are used, free from patent defect and properly maintained. Ladders providing access to the hold should comply with the standards in Annex 11.1.

11.8.3 Suitable handholds should be provided at the top and at any intermediate landing place of all fixed ladders.

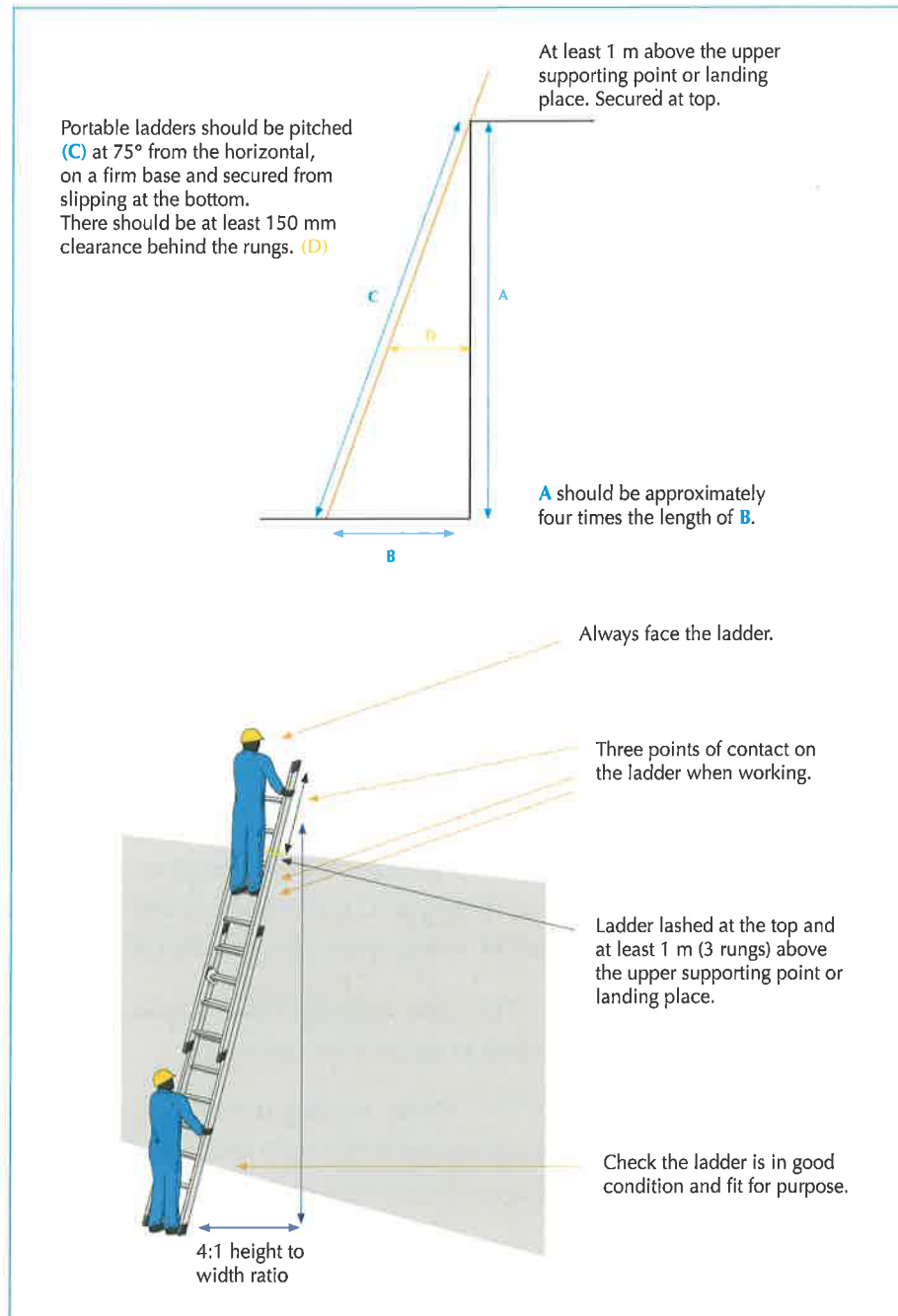

11.8.4 A portable ladder should only be used where no safer means of access is reasonably practicable.

11.8.5 Portable ladders should be pitched at 75° from the horizontal, properly secured against slipping or shifting sideways and be so placed as to afford a clearance of at least 150 mm behind the rungs. Where practicable, the ladder should extend to at least 1 metre above any upper landing place unless there are other suitable handholds.

Blank page

11.9 Shipboard vehicles

11.9.1 Seafarers selected to drive the ship's powered vehicles and powered mobile-lifting appliances should be fit to do so, and have been trained for the particular category of vehicle or mobile-lifting appliance to be driven, and tested for competence.

11.9.2 Authorisations of seafarers should either be individually issued in writing or comprise a list of persons authorised to drive. These authorisations may need to be made available for inspection to port authorities.

11.9.3 Maintenance of the ship's powered vehicles and powered mobile-lifting appliances should be undertaken in accordance with the manufacturer's instructions.

11.9.4 Drivers of the ship's powered vehicles and powered mobile-lifting appliances should exercise extreme care, particularly when reversing.

11.10 Entry into dangerous (enclosed) spaces

S.I. 1988/1638

11.10.1 A dangerous (enclosed) space is defined in the regulations as 'any enclosed or confined space in which it is foreseeable that the atmosphere may at some stage contain toxic or flammable gases or vapours, or be deficient in oxygen, to the extent that it may endanger the life or health of any person entering that space.' Section 15.4 gives advice on identifying these hazards.

11.10.2 The master is required to ensure that all unattended dangerous spaces are secured against entry, except when it is necessary to enter.

11.10.3 The Company must have procedures in place for entering and working in dangerous spaces, and it is the master's responsibility to ensure these are followed. No person should enter or remain in a dangerous space unless they are trained to do so, and follow the set procedures.

11.10.4 Chapter 15 of this Code provides detailed information on the procedures for entry into dangerous spaces.

11.11 Working on deck while ship is at sea

11.11.1 The responsible officer should ensure that seafarers working on deck are properly instructed in the tasks that they are required to perform.

11.11.2 Seafarers should be prohibited at all times from sitting upon the vessel's bulwark or rail.

11.11.3 Bridge watchkeeping officers should be informed of all work being performed on deck or in deck spaces.

11.12 Adverse weather

11.12.1 If adverse weather is expected, lifelines should be rigged in appropriate locations on deck.

11.12.2 No seafarers should be on deck in conditions that the master considers adverse weather unless it is considered necessary for the safety of the ship, passengers and crew, or the safety of life at sea. Where possible, work should be delayed until conditions have improved, e.g. until daylight, or until the next port of call.

11.12.3 The lashings of all deck cargo should be inspected and tightened, as necessary, when rough weather is expected. Anchors should be secured and hawse and spurling pipe covers fitted and sealed when rough weather is expected, regardless of the expected voyage duration.

11.12.4 Work on deck during adverse weather should be authorised by the master and the bridge watch should be informed. A risk assessment should be undertaken, and a permit to work and a company checklist for work on deck in heavy weather completed.

11.12.5 Any seafarers required to go on deck during adverse weather should wear a lifejacket suitable for working in, a safety harness (which can be attached to lifelines) and waterproof personal protective equipment including full head protection, and should be equipped with a water-resistant UHF radio. Head-mounted torches should be considered.

11.12.6 Seafarers should work in pairs or in teams. All seafarers should be under the command of a competent person.

11.12.7 Use of stabilising fins (if fitted) to reduce rolling, and adjusting the vessel's course and speed should be considered to mitigate the conditions on deck. If possible, visible communication should be maintained from the bridge, but if not other continuous communication should be maintained.

11.13 General advice to seafarers

*S.I. 1997/2962,
Reg. 21*

11.13.1 Seafarers and others on board must take care for their own health and safety in moving around the ship, and in particular must cooperate with any measures put in place for their safety.

11.13.2 Seafarers are reminded to take care as they move about the ship. The following list is not exhaustive but identifies points which are all too often overlooked:

- Seafarers should watch out for tripping hazards, and protrusions such as pipes, framing, etc.
- The possibility of a sudden or heavy roll of the ship should always be borne in mind.
- Suitable footwear should be worn that will protect toes against accidental stubbing and falling loads, will afford a good hold on deck and give firm support while using ladders. Extra care should be taken when using ladders whilst wearing sea boots.
- It is dangerous to swing on or vault over stair rails, guardrails or pipes.
- Injuries are often caused by jumping off hatches, etc.
- Manholes and other deck accesses should be kept closed when not being used; guardrails should be erected and warning signs posted when they are open.
- Spillage of oil, grease, soapy water, etc. should be cleaned up as soon as practicable.
- Areas made slippery by snow, ice or water should be treated with sand or some other suitable substance.
- The presence of temporary obstacles should be indicated by appropriate warning signs.
- Litter and loose objects (e.g. tools) should be cleared up.
- Wires and ropes should be coiled and stowed.
- Lifelines should be rigged securely across open decks in rough weather.
- Stairways and ladders are usually at a steeper angle than is normal ashore.
- Ladders should be secured and ladder steps kept in good condition; care should be taken when using ladders and gangways providing access to or about the vessel, particularly when wearing gloves.
- The means of access to firefighting equipment, emergency escape routes and watertight doors should never be obstructed.

Blank page

Annex 11.1 Standards for hold access

Hold access: ships built after 31 December 1988

Where the keel of a ship is laid or the ship is at a similar stage of construction after 31 December 1988, the following standards of hold access should be provided:

- The access shall be separate from the hatchway opening, and shall be by a stairway if possible.
- The rungs of a fixed ladder, or a line of fixed rungs, shall have no point where they fill a reverse slope.
- The rungs of a fixed ladder shall be at least 300 mm wide, and so shaped or arranged that a person's foot cannot slip off the ends. Rungs shall be evenly spaced at intervals of not more than 300 mm and there shall be at least 150 mm clear space behind each rung.
- There shall be space outside the stiles of at least 75 mm to allow a person to grip them.
- There shall be a space at least 760 mm wide for the user's body, except that at a hatchway this space may be reduced to a clear space of at least 600 mm by 600 mm.
- Fixed vertical ladders should be provided with a safe intermediate landing platform at intervals of not more than 9 metres.
- Where vertical ladders to lower decks are not in a direct line, a safe intermediate landing shall be provided.
- Intermediate landings shall be of adequate width, afford a secure footing and extend from beneath the foot of the upper ladder to the point of access to the lower ladder. They shall be provided with guardrails.
- Fixed ladders and stairways giving access to holds shall be so placed as to minimise the risk of damage to them from cargo-handling operations.
- Fixed ladders shall, if possible, be so placed or installed as to provide back support for a person using them; but hoops shall be fitted only where they can be protected from damage to them from cargo-handling operations.

Hold access: ships built before 1 January 1989

Where the keel of a ship was laid or the ship was at a similar stage of construction before 1 January 1989, at least the following standards of hold access should be provided:

- Access should be provided by steps or ladder, except:
 - at coamings; and
 - where the provision of a ladder on a bulkhead or in a trunk hatchway is clearly not reasonably practicable.

In such cases ladder cleats or cups may be used.

- All ladders between lower decks should be used in the same line as the ladder from the top deck, unless the position of the lower hatch (or hatches) prevents this.
- Cleats or cups should be at least 250 mm wide and so constructed as to prevent a person's foot slipping off the side.
- Each cleat, cup, step or rung of a ladder shall provide a foothold, including any space behind the ladder, at least 115 mm deep. Cargo should not be stowed as to produce this foothold.
- Ladders which are reached by cleats or cups on a coaming should not be recessed under the deck more than is reasonably necessary to keep the ladder clear of the hatchway.
- Shaft tunnels should be equipped with adequate handholds and footholds on each side.
- All cleats, cups, steps or rungs of ladders should provide adequate handholds.

Annex 11.2 Standards for lighting

*MSN 1844(M) and
MGN 481(M)*

- For areas used for loading or unloading of cargo or for other work processes, a lighting level of at least 20 lux should be provided.
- For transit areas, a level of at least 8 lux should be provided (measured at a height of 1 metre above the surface level) unless:
 - a higher level is required by other regulations, e.g. the regulations for crew accommodation (see merchant shipping notice MSN 1844(M) and MGN 481(M)); or
 - provision of such levels of lighting would contravene other regulations, e.g. the Convention on the International Regulations for Preventing Collisions at Sea (COLREG), 1972 (as amended), including signals of distress.
- For access equipment and immediate approaches to it, a lighting level of at least 20 lux should be provided (measured at a height of 1 metre above the surface level), unless:
 - a higher level is required by other regulations; or
 - provision of such levels of lighting would contravene other regulations, e.g. the Convention on the International Regulations for Preventing Collisions at Sea (COLREG), 1972 (as amended), including signals of distress; or
 - where the dangers of tripping or falling are greater than usual because of bad weather conditions or where the means of access is obscured, e.g. by the presence of coal dust. In such circumstances, consideration should be given to a higher level, e.g. 30 lux.
- General rules for where these specific regulations do not apply are given in section 11.5 of this chapter.

Blank page

CHAPTER 12

NOISE, VIBRATION AND OTHER PHYSICAL AGENTS

12.1 General advice

12.1.1 A physical agent is an environmental factor such as noise, vibration, optical radiation and electromagnetic fields that may damage the health of those exposed to them.

12.1.2 The Company's risk assessment will identify where personnel are working in the presence of physical agents hazardous to health or safety, and evaluate any risks from exposure (see Chapter 1, Managing occupational health and safety). Appropriate measures should be taken to remove, control or minimise the risk (see section 12.2).

12.1.3 The risk assessment will also provide information to determine whether health surveillance is appropriate (see Chapter 7, Health surveillance).

12.1.4 The Company should provide information and relevant training to personnel so that they know and understand the risks from any physical agents arising from their work, the precautions to be taken and the results of any monitoring of exposure.

12.1.5 Where exposure to a physical agent arises from the use of a particular piece of equipment, reference should be made to any instructions and operating data supplied by the manufacturer of that equipment.

12.1.6 Reference may also be made where appropriate to any publications on the subject issued by the Health and Safety Executive (HSE) or other appropriate body.

12.2 Prevention or control of exposure to a physical agent

12.2.1 The first consideration should always be to prevent risk by removing exposure to the physical agent concerned (elimination).

12.2.2 Where this is not reasonably practicable, prevention or control of exposure may be achieved by any combination of the following means:

- Use of plant, processes and systems of work that minimise exposure to the physical agent.

- Total or partial enclosure of the equipment concerned.
- Keeping the number of persons who might be exposed to a physical agent to a minimum, and reducing the period of exposure.
- The designation of areas that may be subject to hazardous levels of exposure to a physical agent, and the use of suitable and sufficient warning signs.
- Use of appropriate procedures for the measurement of hazardous levels of exposure to a physical agent, particularly for the early detection of abnormal exposures resulting from an unforeseeable event or an accident.
- Taking collective or individual protection measures.
- Where appropriate, having plans in place to deal with emergency situations that could result in abnormally high exposure to physical agents.

12.2.3 These measures should be applied to reduce the risk to seafarers as much as reasonably practicable but, where they do not adequately control the risk to health, appropriate personal protective equipment (PPE) should be provided.

12.2.4 The Company should take reasonable steps to ensure that all control measures are properly used and maintained. Seafarers should comply fully with the control measures in force.

12.2.5 For certain physical agents, specific control measures apply, e.g. noise and vibration. In cases where failure of the control measures could result in risk to health and safety, or where their adequacy or efficiency is in doubt, the exposure of seafarers should be monitored and a record kept for future reference.

12.3 Consultation

12.3.1 Ship safety representatives and seafarers should be consulted about proposals to manage risks from exposure to physical agents and health problems arising from such exposure. Consultation should cover the results of the risk assessment, proposals for control, procedures for providing information and training for seafarers, and any health-monitoring system.

12.4 Seafarer information and training

12.4.1 The Company should provide seafarers with sufficient information and training to ensure that they are aware of potential risks to their health from exposure to physical agents. Such information should

be provided in the working language of the ship. Training should be in a language understood by the seafarer and should include:

- the nature of such risks;
- details of the measures taken in order to eliminate or reduce to a minimum the risks from the physical agent;
- any exposure limit values (ELVs) and the exposure action values (EAVs) or action levels (ALs);
- the results of the risk assessment carried out;
- safe working practices to minimise exposure to physical agents;
- the correct use of PPE where required;
- the circumstances in which seafarers are entitled to health surveillance;
- how to detect and report signs of injury; and
- the importance of detecting and reporting signs of injury.

12.5 Noise: introduction

*S.I. 2007/3075 and
MGN 352(M+F)*

12.5.1 When exposed to harmful noise – sounds that are too loud or loud sounds that last a long time – sensitive structures in the inner ear can be damaged, causing hearing loss. This section gives advice on the assessment of levels of noise in the workplace, and steps to prevent any associated problems they may cause.

12.5.2 Noise may also be a safety hazard at work, interfering with communication and making warnings harder to hear.

12.6 Assessing exposure to noise

12.6.1 Noise is measured in decibels (dB). An 'A-weighting', sometimes written as dB(A), is used to measure average noise levels and a 'C-weighting', or dB(C), to measure peak, impact or explosive noises. Because of the way our ears work, a 3 dB change in noise level is not very noticeable. Yet every 3 dB doubles the noise level, so what might seem like small differences in the numbers can be quite significant.

12.6.2 Annex 12.2 provides guidance on daily exposure to different sound levels and the recommended maximum limits for different areas on board ship.

12.6.3 The following table describes the lower and upper noise exposure values, noise exposure limits and, where appropriate, action required to reduce that exposure.

	Daily/ weekly exposure (dB(A))	Peak exposure (dB(C))	Required action
Lower exposures action values	80	135	Seafarers should be provided with personal hearing protection that complies with the requirements of the Merchant Shipping and Fishing Vessels (Personal Protective Equipment) Regulations 1999.
Upper exposures action values	85	137	Seafarers are required to use personal hearing protection that complies with the requirements of the Merchant Shipping and Fishing Vessels (Personal Protective Equipment) Regulations 1999. Seafarers are entitled to have their hearing examined by a doctor, or a suitably qualified person under the supervision of a doctor. Companies should establish and implement a programme of measures to reduce the exposure to noise.
Exposure limit values	87	140	This limit must not be exceeded.

12.6.4 For further information on personal hearing protection, see Annex 12.3.

12.6.5 Seafarers should not be charged for either personal hearing protectors or hearing examinations as a result of risks at work.

12.6.6 When determining noise exposure action levels, no account is to be taken of the effects of using hearing protection. However, account may be taken of the reduction achieved by hearing protection in the case of ELVs.

12.6.7 Although being aware of decibel levels is an important factor in protecting hearing, distance from the source of the sound and duration of exposure to the sound are equally important.

12.6.8 As a simple guide, there may be a problem if:

- seafarers have to shout to be clearly heard by someone only 2 metres away;
- seafarers' ears are still ringing after leaving the workplace;

- seafarers are using equipment that causes loud explosive noises, such as cartridge-operated tools or guns;
- seafarers are exposed to high-level impact noise from hammering on metal benches, chipping machines or metal endplates on the decks of roll-on/roll-off ferry vessel ramps;
- there is machinery such as diesel engines, generators, etc. running in a confined space like a ship's engine room;
- seafarers not engaged in the provision of entertainment (e.g. waiters) have to enter or remain in noisy areas such as discos and nightclubs on cruise ships whilst carrying out their duties.

12.7 Risk assessment: noise

12.7.1 If exposure to noise may be a problem, a risk assessment should be undertaken by a competent person.

12.7.2 If any seafarer is likely to be exposed to noise exceeding the lower EAVs set out in section 12.6.3, the Company should arrange for a competent person to assess the actual level of noise exposure.

12.7.3 The Company should:

- keep a record of the noise assessment;
- regularly review the noise assessment whenever there is a change in the work being undertaken or when new equipment is introduced that may alter noise levels; and
- use the assessment to develop an action plan for introducing noise control measures.

12.7.4 It is good practice to review the assessment every two years, because noise levels can change over time as, for example, machinery wears out or working practices change.

12.7.5 Safety signs should be displayed in all areas of the ship where seafarers are likely to be exposed to noise. (For further information, see Chapter 9, Safety signs and their use.)

12.8 Health surveillance: noise

12.8.1 Where risk assessment shows that exposure to noise may be causing problems, the employer is required to provide health surveillance of the seafarers at risk in accordance with Chapter 7, Health surveillance.

12.8.2 Health surveillance should include:

- regular hearing checks to measure the sensitivity of hearing over a range of sound frequencies;

- informing employees about the results of their hearing checks;
- keeping records; and
- encouraging seafarers to seek further advice from a doctor when hearing damage is suspected.

12.8.3 The organisation responsible for the carrying out of health surveillance should use the most appropriate form of health surveillance in the circumstances.

12.8.4 Companies should arrange regular hearing checks for all seafarers who are regularly exposed to potentially harmful noise levels.

12.8.5 Further guidance is available in the Maritime and Coastguard Agency (MCA)'s official guide to complying with the Merchant Shipping and Fishing Vessels (Noise at Work) Regulations 2007.

12.9 Noise arising from music and entertainment

MGN 377(M+F)

12.9.1 A code of conduct has been drawn up by HSE and industry representatives from the music and entertainment sector. The Code enables those sectors to meet the requirements of HSE's noise regulations. The provisions of the HSE Code are equally relevant to the provision of music and entertainment on ships, including vessels on inland waterways, although the applicable legislation for ships will be the Merchant Shipping and Fishing Vessels (Control of Noise at Work) Regulations 2007 and not HSE's regulations.

*S.I. 2007/3077 and
MGN 353(M+F)*

Vibration

12.10 Types of vibration and their effects

12.10.1 Hand–arm (or hand-transmitted) vibration comes from the use of hand-held power tools or other vibrating equipment. Regular and frequent exposure to hand–arm vibration can lead to permanent health effects. Occasional exposure is unlikely to cause ill health.

12.10.2 Whole-body vibration occurs through the shaking or jolting of the body through a supporting surface, e.g. when controlling or riding on a vessel at high speed in choppy seas, using mobile equipment or standing next to a ship's main engines or generators. Whole-body vibration can also be made worse by poor design of the working environment, incorrect seafarer posture, and exposure to shocks and jolts. A primary symptom of whole-body vibration is back pain.

12.11 Exposure limits set by the vibration regulations

The following table describes the daily EAVs and ELVs for hand–arm and full-body vibration.

	Hand–arm vibration (standardised to eight-hour reference period)	Whole-body vibration	
Daily exposure action value	2.5 m/s ² A(8)	0.5 m/s ² A(8)	Above this limit, Companies are required to reduce seafarer's exposure to vibration.
Daily exposure limit value	5 m/s ² A(8)	1.15 m/s ² A(8)	The maximum amount of vibration an employee may be exposed to on any single day.

12.12 Determining vibration levels

12.12.1 The Company is required to control the risks from hand–arm and whole-body vibration. In most cases, it is simpler to make a broad assessment of the risk rather than try to assess exposure in detail.

12.12.2 During the assessment, attention should be paid to:

- which, if any, processes/operations involve regular exposure to vibration, including that emanating from the vessel itself;
- whether there are any warnings of vibration risks in equipment handbooks; and
- any symptoms that might be caused by hand–arm or whole-body vibration and whether the equipment being used, or the vessel itself, produces high levels of vibration or uncomfortable strains on hands and arms, or is causing back pain.

12.12.3 If exposure to vibration is causing problems, a risk assessment should be undertaken by a competent person who has read and understood the vibration regulations.

12.12.4 As an alternative, the Company may choose either to use available vibration data or to have measurements made to estimate exposures if they want to be more certain of whether the risk is high, medium or low.

12.12.5 The Company may be able to get suitable vibration data from the equipment handbook or the equipment supplier. Should such data be reasonably representative of the way equipment is used on the vessel, it should be suitable for use in estimating seafarers' exposure.

12.12.6 It is also necessary to note how long seafarers are exposed to vibration. Once the relevant vibration data and exposure times have been collected, it will be necessary to calculate each seafarer's daily exposure. This could be by means of an exposure calculator such as HSE's one on vibration at work available from its website or, alternatively, by using the simple exposure points system table below.

Tool vibration (m/s ²)	3	4	5	6	7	10	12	15
Points per hour (approximate)	20	30	50	70	100	200	300	450

12.12.7 Multiply the points assigned to the tool vibration by the number of hours of daily 'trigger time' for the tool(s) and then compare the total with the EAV and ELV points:

- 100 points per day = exposure action value (EAV).
- 400 points per day = exposure limit value (ELV).

12.13 Mitigation

12.13.1 If exposure to vibration is causing problems, the Company is required to do all that is practicable to eliminate the risk or minimise it.

12.13.2 The Company should group work activities according to whether they are high, medium or low risk. Action plans should be prioritised for seafarers at greatest risk. As a general guide, the controls described in section 12.2 should be followed.

12.13.3 Alternative work methods that eliminate or reduce exposure to vibration should be sought.

12.14 Mitigation: hand–arm vibration

12.14.1 The Company should design workstations to minimise the load on seafarers' hands, wrists and arms and, where appropriate, use devices such as jigs and suspension systems to reduce the need to grip heavy tools tightly.

12.14.2 The Company should ensure equipment provided for tasks is suitable and can do the work efficiently. The tool causing the lowest vibration level that is suitable and can do the work efficiently should be

selected. The use of high-vibration tools should be avoided wherever possible.

12.14.3 When work equipment requires replacement because it is worn out, the Company should choose replacements that are suitable for the work to be carried out, efficient and, wherever possible, cause lower vibration levels. It is recommended that the Company has a policy on purchasing suitable equipment, taking account of vibration emission, efficiency and any specific requirements.

12.14.4 Appropriate maintenance programmes for equipment should be drawn up to prevent avoidable increases in vibration through the use of blunt or damaged equipment or consumable items.

12.14.5 Seafarers using equipment that can cause vibration should be provided with appropriate training and instruction on its correct use.

12.14.6 The Company should plan tasks to avoid seafarers being exposed to vibration for long, continuous periods.

12.14.7 Seafarers should be provided with protective clothing where appropriate. Whilst gloves can be used to keep hands warm, they may not in themselves provide protection from vibration.

12.14.8 Further guidance is available in the MCA's official guide to complying with the Merchant Shipping and Fishing Vessels (Control of Vibration at Work) Regulations 2007.

12.15 Mitigation: whole-body vibration

12.15.1 Vibration may be reduced by regular maintenance of engines and machinery, adjusting the speed of operation or other settings. Seafarers should be provided with information on how to minimise vibration in this way. Severe shocks or jolts should be avoided as far as possible.

12.15.2 When exposure to vibration is unavoidable, the risk of harm can be reduced by:

- scheduling work to avoid long periods of exposure to vibration in a single day;
- planning work so that seafarers do not have to sit in one position for too long;
- ensuring that seafarers maintain good posture while working, e.g. arranging tasks as far as possible to avoid twisting and stretching;
- where possible, adjusting seating to provide good lines of sight, adequate support to the back, buttocks, thighs and feet, and ease of reach for foot and hand controls;

- providing adequate rest periods, e.g. allow a short break between operations in small fast vessels or mobile machinery and manual handling, to give tired muscles time to recover before handling heavy loads;
- if working in cold and damp conditions, ensuring that seafarers wear warm, and (if necessary) waterproof clothing; cold exposure may accelerate the onset or worsen the severity of back pain.

When all reasonable steps have been taken to avoid exposure to vibration and to reduce the level of vibration, the final resort for compliance with the ELV is to limit the duration of exposure.

MGN 436(M+F)

12.15.3 Marine guidance note MGN 436(M+F) gives guidance on mitigating the risks from whole-body vibration for those working in small, fast craft.

12.15.4 Further guidance is available in the MCA's official guide to complying with the Merchant Shipping and Fishing Vessels (Control of Vibration at Work) Regulations 2007.

12.16 Health surveillance and health monitoring: vibration

12.16.1 If there is considered to be a potential risk of harm to seafarers from hand–arm vibration, health surveillance should be provided for vibration-exposed seafarers in accordance with Chapter 7, Health surveillance, of this Code. This will apply when seafarers:

- are likely to be regularly exposed above the EAV of 2.5 m/s² A(8);
- are likely to be exposed occasionally above the EAV and where the risk assessment identifies that the frequency and severity of exposure may pose a risk to health; or
- have a diagnosis of hand–arm vibration syndrome (HAVS) (even when exposed below the EAV).

12.16.2 Specific guidance on health surveillance for hand–arm vibration risks is available on the HSE website.

12.16.3 Monitoring symptoms of back pain may be useful for identifying health problems and intervening to prevent problems being caused or made worse by work activities. It can also provide information on the effectiveness of current control methods in place, and identify those who are particularly sensitive to whole-body vibration. Older seafarers, people with back problems, young seafarers and pregnant seafarers are at greater risk. Guidance on health monitoring for those at risk from whole-body vibration is available on the HSE website.

MGN 353(M+F)

12.17 Additional guidance

Sources of additional guidance are listed in marine guidance note MGN 353(M+F).

12.18 Other physical agents

Guidance on protection from artificial optical radiation and electromagnetic fields are listed in the Appendices.

Blank page

Annex 12.1 Examples of typical dB(A) levels

Examples of noise levels in different locations are given below in order to enable personnel to appreciate when and where a potentially harmful noise exposure may exist.

120 dB(A)	60 metres from a jet aircraft taking off. Between two running 1800 rpm diesel generators.
110 dB(A)	1 metre from a riveting machine. In a small ship engine room with 900 rpm diesel main engines and a 1550 rpm diesel generator.
105 dB(A)	1 metre from cylinder tops of a slow speed (120 rpm) main diesel engine.
100 dB(A)	Between two running diesel generators (600 rpm).
95 dB(A)	In a slow speed (120 rpm) diesel main engine room at the after end on the floor plate level or in an open side flat.
90 dB(A)	Noisy factory, machine shop, quieter parts of ships' engine rooms.
80 dB(A)	15 metres from a pneumatic drill.
70 dB(A)	Noisy domestic machinery (vacuum cleaner at 3 metres).
60 dB(A)	Inside large public building (e.g. supermarket).
50 dB(A)	Inside a house in a suburban area during daytime.
40 dB(A)	Quiet city area outdoors at night. Library whisper at 1 metre.
25–30 dB(A)	Countryside at night with no wind. Quiet church.
0	Threshold of hearing of young persons of normal hearing.

These levels are only illustrative and noise levels can vary between similar locations. This is especially true of engine rooms because engine noise can vary considerably with the type of installation.

Blank page

Annex 12.2 Daily exposure to different sound levels

In the circumstances that occur on board ship, where personnel move from one place to another and the length of time spent in each place may vary, they may be exposed to different levels of noise throughout the day.

The following figures give a guide to the acceptable maximum daily noise doses for unprotected ears, based on dB(A) sound energy received.

less than	80 dB(A)		no limit (24 hours)
	82 dB(A)	for	16 hours
	85 dB(A)	for	8 hours
	90 dB(A)	for	2 hours
	95 dB(A)	for	50 minutes
	100 dB(A)	for	15 minutes
	105 dB(A)	for	5 minutes
	110 dB(A)	for	1 minute

As an alternative illustration and equivalent to the above figures, the maximum daily noise dose for unprotected ears is halved for each increase of 3 dB(A).

Recommended maximum limits for different areas on board ship

The limits below should be regarded as maximum levels, rather than desirable levels and, as appropriate, take account of the attenuation (noise reduction) that can be achieved with ear protectors.

Area	Recommended limit
Machinery spaces – general	90 dB(A)
Machinery spaces – unmanned	110 dB(A)
Machinery control rooms	75 dB(A)
Wheelhouse/bridge/chart room/radar room	65 dB(A)
Bridge wings	70 dB(A)
Radio room/communications centre	60 dB(A)
Galleys, serveries, pantries	75 dB(A)
Normally unoccupied spaces	90 dB(A)
Sleeping cabins, day cabins, hospital	60 dB(A)
Offices, conference rooms, etc.	65 dB(A)
Mess rooms, recreation rooms, recreation areas	65 dB(A)
Open deck areas	75 dB(A)
Corridors, changing rooms, bathrooms, lockers and similar spaces	80 dB(A)
Ship's whistle	110 dB(A)

MGN 352(M+F),
Annex 1

Blank page

Annex 12.3 Personal hearing protection

1. The hearing protection required to be provided by virtue of the Merchant Shipping and Fishing Vessels (Control of Noise at Work) Regulations 2007 is a last resort to control noise exposure. It should only be used:

- as a short-term measure until other controls to reduce the noise exposure have been introduced; or
- when all reasonably practicable measures have been taken and a risk to hearing remains.

2. Any hearing protection provided to seafarers is required to comply with the requirements of the Merchant Shipping and Fishing Vessels (Personal Protective Equipment) Regulations 1999. However, not all hearing protectors are the same and different types may be more suitable for different seafarers or indeed the work being undertaken. In this respect the main types of hearing protection are:

- earmuffs, which completely cover the ear – however, the effectiveness of earmuffs may be reduced if the wearer is also wearing glasses (see section 8.6.4);
- earplugs, which are inserted in the ear canal (see section 8.6.3); and
- semi-inserts (also called ‘canal caps’), which cover the entrance to the ear canal.

3. In choosing what form of hearing protection to provide, Companies should use the results from their noise assessment and information from hearing protection suppliers to make the best choice of hearing protection for the particular work being undertaken. Whatever form of protection is chosen, it must:

- reduce employees’ noise exposure to below 85 dB(A);
- be suitable for the employees’ working environment – consider comfort and hygiene; and
- be compatible with other protective equipment used by the employee, e.g. safety helmet, dust mask and eye protection.

Wherever possible, seafarers should be provided with a suitable range of effective hearing protection so they can choose the one that suits them best. Some seafarers may prefer a particular type, or may not be able to use some types of hearing protection because of the risk of ear infections.

Particular consideration should be given to those seafarers who wear spectacles or eye protection similar to spectacles, which have arms that

go over the ear. In such cases, earmuffs may not fit securely against the ear because of the presence of the spectacle arms and thus provide inadequate protection against noise. In such circumstances, another form of ear protection may be more suitable.

4. Maintenance

Companies should ensure that hearing protection works effectively and check that:

- its overall condition is still good and it is clean;
- earmuff seals are undamaged;
- the tension of the headbands is not reduced;
- there are no unofficial modifications; and
- compressible earplugs are soft, pliable and clean.

5. Supervision

Companies should ensure that seafarers use hearing protection when required to. In this context, Companies may want to:

- include the need to wear hearing protection in their safety policy, and put someone in authority in overall charge of issuing it and making sure that replacement hearing protection is readily available;
- carry out spot checks to see that the rules are being followed and that hearing protection is being used properly;
- consider whether failure to use hearing protectors when required to do so should be included in the Company's disciplinary procedures; and
- ensure that all managers and supervisors set a good example and wear hearing protection at all times when in ear-protection zones.

CHAPTER 13

SAFETY OFFICIALS

13.1 Introduction

13.1.1 Every person on board has a responsibility for safety:

- The Company is responsible for ensuring the overall safety of the ship and that safety on board is properly organised and coordinated.
- The master has the day-to-day responsibility for the safe operation of the ship and the safety of those on board.
- Each employer is responsible for the health and safety of their workers.
- Heads of department are responsible for health and safety in their own department.
- Each officer/manager is responsible for health and safety for those they supervise and others affected.
- Each individual seafarer or worker is responsible for their own health and safety and that of anyone affected by their acts and omissions.

S.I. 1997/2962

13.1.2 Under merchant shipping legislation, specific responsibilities are also given to those with designated roles in ensuring the safety of those on the ship. In this chapter, those with a designated safety role on board are referred to as 'safety officials', and this term includes safety officers, safety representatives and other members of safety committees.

13.1.3 As described in Chapter 1, Managing occupational health and safety, the development of a positive 'safety culture' and the achievement of high standards of safety depend on good organisation and the whole-hearted support of management and all seafarers. Those with specific safety responsibilities are more likely to perform well when management is clearly committed to health and safety. It is also important that procedures are in place so that all seafarers can cooperate and participate in establishing and maintaining safe working conditions and practices.

13.1.4 Some sections of this chapter apply equally on all ships, whether or not safety officials are appointed or elected by law. Other sections, where indicated, apply only to ships with five or more seafarers, where safety officials are appointed or elected as required by law. The information and guidance here is designed to assist them in their functions, and to advise companies and masters how to fulfil their duty to assist them.

13.2 Employer duties

Reg. 14(1)

13.2.1 This section applies to all ships. Every employer is required to appoint one or more competent persons to promote health and safety in their undertaking. On board some large ships, where there are personnel working who are employed by several different employers, each employer must appoint (a) competent person(s). They do not have to work on the ship themselves, but to be 'competent' for the task they should have a knowledge of the duties undertaken by those for whom they are responsible, and should ensure that any specific risks encountered as a result of that particular working environment are dealt with appropriately, e.g. by checking that the Company has adequate safety procedures for all on board, and by coordinating risk assessments with the Company.

13.2.2 The employer may 'appoint' themselves where, in a small organisation, there is no one else available to take on this responsibility. Alternatively, they may employ someone from outside their own undertaking to advise on health and safety, provided that person is competent.

Reg. 19(1)

13.2.3 The employer must provide the competent person(s) with all relevant information they need to do their job. This includes a copy of the Company's safety policy and risk assessments, information about the duties of personnel, and any information provided by other employers about risks and safety procedures in shared workplaces.

Reg. 20(1)

13.2.4 The employer is required to consult workers or their elected representatives on health and safety matters, in particular:

- arrangements for the appointment of a competent person;
- the findings of the risk assessment;
- arrangements for health and safety training; and
- the introduction of new technology.

The matters to be discussed might also include the selection of work equipment and/or protective clothing and equipment, installation of safety signs, follow-up to accidents and other incidents, and arrangements for health surveillance.

13.2.5 Seafarers and other workers on board or their elected representatives must be allowed to make representations to the Company or their employer about health and safety matters without disadvantage to themselves. Such representations should be given adequate consideration, perhaps in conjunction with the safety committee, and any agreed measures to improve safety implemented as soon as reasonably practicable.

Reg. 20(3)

13.2.6 It is also the Company's and the employer's responsibility to ensure that workers or their elected representatives have access to relevant information and advice about health and safety matters from inspection agencies and health and safety authorities and, from their own records, about accidents, serious injuries and dangerous occurrences.

Reg. 20(4)

13.2.7 The Company and the employer must give elected representatives adequate time off normal duties, without loss of pay, to enable them to exercise their rights and carry out their function effectively. Safety representatives must not suffer any disadvantage for undertaking this function.

13.3 Company duties

13.3.1 The regulations

S.I. 1997/2962,
Regs 15–18

13.3.1.1 This section applies only to ships on which five or more seafarers are working. The regulations dealing with safety officials give duties to the Company for the appointment of ships' safety officers (see section 13.3.2 of this Code), the election of safety representatives with specified powers (section 13.3.3) and the appointment of a safety committee (section 13.3.4).

13.3.1.2 The Secretary of State may grant ad hoc exemptions to specific ships or classes of ships subject to any relevant special conditions. This is to allow different arrangements to be made in cases where the requirements of the regulations would be difficult to apply. An example might be a multi-crew ship with alternate crews working on a regular shift basis. In considering a request for exemption, the Maritime and Coastguard Agency (MCA) would need to be satisfied that effective alternative arrangements existed, and would make it a condition of the exemption that these were continued.

13.3.2 Appointment of safety officers

Reg. 15

13.3.2.1 On every seagoing ship on which five or more seafarers are employed, the Company is required to appoint a safety officer. The master must record the appointment of a safety officer – this should be in the official logbook.

13.3.2.2 The safety officer is the safety adviser aboard the ship and can provide valuable assistance to the Company and to all on board in meeting the statutory responsibilities for health and safety. Some training may be provided on board, but the safety officer should have attended a suitable safety officer's training course.

Suitable safety officer training should cover the following topics:

- The tasks of the safety committee.
- The rights and roles of members of the safety committee.
- How to carry out risk assessment and management.
- How to provide the necessary advice to resolve safety concerns or problems and to encourage adherence to prevention principles.
- Supervision of safety tasks assigned to crew and other seafarers on board, and passengers where applicable.
- Accident and incident investigation, analysis and making appropriate corrective and preventative recommendations to prevent their recurrence.
- How to obtain relevant information on a safe and healthy working environment from the competent authority and the Company.
- Effective means of communication with a multinational crew.
- The commitment required to promote a safe working environment on board.

In addition, the safety officer should be familiar with the following:

- The occupational safety and health policy and programmes used on board.
- The safety tasks assigned to crew and other personnel on board, and passengers where applicable.

The safety officer should be familiar with the principles and practice of risk assessment, and should be available to advise those preparing and reviewing risk assessments. It is recognised that, where the safety officer also has other responsibilities (e.g. chief officer) they may well conduct risk assessments themselves. However, the general principle is that the safety officer takes an independent view of safety on behalf of the Company.

13.3.2.3 Although not prohibited by the regulations, the appointment of the master as the safety officer is not generally advisable. This is because the safety officer is required amongst other duties to make representations and recommendations on health and safety to the master.

13.3.2.4 If possible, the Company should avoid appointing as safety officer anyone to whom the master has delegated the task of giving medical treatment. This is because one of the duties of the safety officer is to investigate incidents, and they would not be able to give proper attention to this function while providing medical treatment for any casualties.

Reg. 17

13.3.3 Election of safety representatives

13.3.3.1 On every ship on which five or more seafarers are working, the Company must make arrangements for the election of safety representatives. The regulations specify that no safety representative may have fewer than two years' consecutive sea service since attaining the age of 18, which in the case of a safety representative on board a tanker shall include at least six months' service on such a ship.

13.3.3.2 The Company must make rules for the election of safety representatives and cannot disqualify particular persons. It is recommended that the Company should consult with any seafarers' organisation representing seafarers on the ship when making these rules. The master should organise the election of a safety representative within three days of being requested to do so by any two persons entitled to vote.

13.3.3.3 The number of safety representatives who should be elected will vary according to the number of seafarers on board and where appropriate the number of different departments or working groups. As far as practicable, seafarers at all levels and in all departments should have effective representation.

13.3.3.4 The master must record the election or appointment of every safety representative in writing – this should be either in the official logbook or in the minutes of safety committee meetings (see below).

13.3.3.5 When there is a substantial change in those working on board, the master should remind seafarers of their right to elect new safety representatives.

13.3.3.6 Regulation 17, governing arrangements for the election of safety representatives, does not apply where there are existing agreed arrangements under land-based legislation (The Safety Representatives and Safety Committee Regulations 1977 or The Offshore Installations (Safety Representatives and Safety Committees) Regulations 1989 or the Health and Safety (Consultation with Employees) Regulations 1996).

13.3.4 Appointment of a safety committee

Reg. 17(4)

13.3.4.1 The Company is required to appoint a safety committee on every ship with five or more seafarers. The committee must be chaired by the master, and members will include, as a minimum, the safety officer and any elected safety representatives. If practical, in addition to the Company's competent person, any competent person appointed by other employers should be invited to attend.

13.3.4.2 The master must record the appointment of a safety committee in writing – this should normally be in the official logbook or minutes of the committee’s meetings.

13.3.4.3 The composition of a safety committee recommended above does not preclude the appointment of other temporary members. However, the committee should be kept compact enough to maintain the interest of members and enable it to function efficiently. Where possible, the relevant shore managers with responsibility for safety on board may attend safety committee meetings on board ship and should in any event see the committee’s minutes. On short-haul ferries on which different crews work a shift system, a scheme of alternate committee members may be adopted to secure proper representation.

13.3.4.4 Where large numbers of seafarers work in separate departments (e.g. passenger ship galleys and restaurants), departmental sub-committees may be formed on lines similar to those of the main committee and under the chairmanship of a senior member of the department who should serve as a member of the main safety committee in order to report the views of the sub-committee.

13.3.4.5 It is preferable to appoint as secretary someone other than a safety official, as officials need to concentrate on the discussion rather than on recording it.

13.3.5 Termination of appointments

13.3.5.1 A safety officer’s appointment ends as soon as the officer ceases to work in the particular ship or their appointment is otherwise terminated.

13.3.5.2 The appointment of a safety representative cannot be terminated by the Company, employer or master. They can resign or seafarers can elect another in their place. Otherwise they remain a safety representative for as long as they serve on the ship.

13.3.5.3 A safety committee may be disbanded only when there are fewer than five seafarers working on board the ship. A safety committee can operate whether or not there is an elected safety representative.

13.3.5.4 For ships with fewer than five seafarers on board, the master should ensure that information sharing, training and consultations on health and safety issues are carried out on board.

13.3.6 Support for safety officials

Reg. 19(1)

13.3.6.1 The Company and master have a duty to facilitate the work of any safety official, providing them with access to a copy of this Code and any relevant legislation, marine notices and other information, including:

- findings of the risk assessment and measures for protection in place;
- any other factors affecting the health and safety of those working on the ship;
- details of firefighting, first aid and other emergency procedures; and
- statistical information taken into account when conducting risk assessments.

13.3.6.2 Relevant information might include that concerning dangerous cargoes, maintenance work, the hazards of machinery, plant and equipment, processes and substances in use, and appropriate precautions. This will require coordination with all employers to obtain information about the findings of their risk assessment.

13.3.6.3 The Company and master, in cooperation with other employers, must also ensure that safety officials have the necessary resources and means. This will include providing any necessary accommodation and office supplies. They should also allow them sufficient time off from their duties without loss of pay, to enable them to fulfil their functions or undertake any necessary health and safety training.

13.3.7 Company recording of accidents

*Reg. 19(2)
S.I. 2012/1743 as
amended*

13.3.7.1 On a ship where no safety officer is appointed under the regulations, the Company must ensure that a record is kept of all incidents resulting in death, or serious injury as defined in the Merchant Shipping (Accident Reporting and Investigation) Regulations 2012. This record must be available on request to any elected representative, and any person duly authorised by the Secretary of State.

13.3.8 Receiving representations about health and safety

13.3.8.1 The Company and employers must enable seafarers and others working on board or their elected representatives to make representations about health and safety, and should also accept representations or recommendations from the safety officer. The Company and master will also receive representations from competent persons appointed under regulation 15, safety officers and safety committees. These should be carefully considered and any agreed measures should be implemented as soon as reasonably practicable.

13.3.8.2 The reaction to such representations will be seen as a measure of commitment to health and safety on board. All representations received, from any source, should be considered carefully. If there is likely to be a delay in giving an answer, then whoever has made the representations should be informed as soon as possible. Safety suggestions should be implemented, when it is feasible and reasonable to do so, as soon as reasonably practicable. If suggestions for health and safety measures are rejected, reasons should be given in writing. It is a good practice to acknowledge all suggestions put forward, whether or not a written response is needed.

13.3.8.3 It is most important that the master takes a close interest in the work of the safety officials on board. The master should check that the safety officer is fulfilling their duties effectively, but should also give encouragement and support. The master is in much the best position to ensure that the committee works successfully, by encouraging participation and cooperation from all members.

13.3.8.4 The accident reporting regulations govern when an incident should be reported to the Marine Accident Investigation Branch (MAIB) of the Department for Transport. It may sometimes be appropriate for the Company to inform other ships in the fleet of an incident, and give appropriate recommendations on action to be taken, in accordance with the Company's safety management system.

S.I. 2012/1743 as amended

13.4 Duties of safety officers

S.I. 1997/2962, Reg. 16

13.4.1 General advice to safety officers

13.4.1.1 It is very important that the safety officer maintains a good working relationship with safety representatives by, for example, inviting the relevant safety representatives to join in the regular inspection of each part of the ship or, while carrying out an investigation, consulting them on safety matters and arrangements, and in particular on any follow-up action proposed.

13.4.1.2 The safety officer's relationship with the safety committee is rather different since the safety officer is both a member of the committee and also to some extent subject to its direction. A committee has the right to inspect any of the records that a safety officer is required by law to keep, and has the power to require the safety officer to carry out any health or safety inspections considered necessary.

13.4.2 Advice on compliance with safety requirements

13.4.2.1 The safety officer is required by the regulations to try to ensure compliance with the provisions of this Code and any health and safety guidance and instructions for the ship.

Reg. 16

13.4.2.2 The safety officer's role should be a positive one, seeking to initiate or develop safety measures before an incident occurs rather than afterwards. The safety officer should do the following:

- Be on the lookout for any potential hazards and the means of preventing incidents.
- Try to develop and sustain a high level of safety consciousness among seafarers so that individuals work and react instinctively in a safe manner and have full regard to the safety not only of themselves but also of others. The objective is to become the ship's adviser on safety to whom the master, officers and all seafarers will naturally turn for advice or help on safe working procedures.
- Where unsafe practice is observed, approach the individual or responsible officer concerned to suggest improvements in the method of working or use the safety committee to discuss examples of dangerous or unsafe practices in a particular area. If this brings no improvement, the safety officer should consider approaching the head of department or, as a last resort, the master to use their influence.
- Ensure that each worker joining the ship is instructed in all relevant health and safety arrangements, and of the importance attached to them before starting work. A suggested outline for this induction is given in Chapter 2, Safety induction.
- Where possible, ensure that arrangements are made for each new entrant to work with a seafarer who is thoroughly safety conscious.
- Remind experienced seafarers joining the ship for the first time of the importance of a high level of safety consciousness and of setting a good example to less experienced seafarers.

13.4.2.3 The safety officer should also promote safety on board, subject to the agreement of the master, by:

- arranging the distribution of booklets, leaflets and other advisory material on safety matters;
- supervising the display of posters and notices, replacing and renewing them regularly;
- arranging for the showing of films on safety publicity and, where appropriate, organising subsequent discussions on the subjects depicted;
- encouraging seafarers to submit ideas and suggestions for improving safety and enlisting their support for any proposed safety measures which may affect them (the person making a suggestion should always be informed of decisions reached and any action taken); and

- effectively communicating new requirements or advice in relevant shipping legislation, marine notices and Company and ship's rules and instructions relating to safety at work about the ship.

13.4.3 Investigation of accidents and dangerous occurrences

13.4.3.1 The safety officer has a duty to investigate notifiable accidents or dangerous occurrences affecting persons on board ship or during access, as well as potential hazards to health and safety and any reasonable complaints made by any personnel, and to make recommendations to the master. It is good practice to record and investigate as appropriate all incidents reported by personnel or passengers.

13.4.3.2 Additional health or safety investigations or inspections may be commissioned by the safety committee.

13.4.4 Safety inspections

13.4.4.1 The regulations require the safety officer to ensure that health and safety inspections of each accessible part of the ship are carried out at least once every three months, or more frequently if there have been substantial changes in the conditions of work.

13.4.4.2 'Accessible' should be taken as meaning all those parts of the ship to which any seafarer has access without prior authority.

13.4.4.3 Deciding whether 'substantial changes in the conditions of work' have taken place is a matter of judgement. Changes are not limited to physical matters such as new machinery but can also include changes in working practices or the presence of possible new hazards. A record should be kept of all inspections.

13.4.4.4 It is not necessary to complete an inspection of the whole ship at one time, as long as each accessible part of the ship is inspected every three months. It may be easier to get quick and effective action on recommendations arising out of an inspection if one section is dealt with at a time. The safety officer should ensure that the inspections are carried out when necessary. Before beginning any inspection, previous reports of inspections of the particular section should be read, together with the recommendations made and the subsequent action taken. The control measures identified in any relevant risk assessment should also be read, and compliance with them checked during the inspection. Any recurring problems should be noted and, in particular, recommendations for actions that have not been put into place. It is important, however, not to allow the findings of previous inspections to prejudice any new recommendations.

13.4.4.5 It is not possible to give a definitive checklist of everything to look for but safe access, the environment and working conditions are major items. Suggestions for consideration on these particular issues are given in Annex 13.1.

13.4.4.6 The safety officer is required to make representations and where appropriate recommendations to the master, and through the master to the Company, about any deficiency in the ship in respect of statutory requirements relating to health and safety, relevant merchant shipping notices and the provisions of this Code.

13.4.4.7 In order to fulfil this function properly, the safety officer needs to be familiar with the appropriate regulations. The introduction of new regulations or of amendments to existing regulations will be announced in marine notices issued by the MCA.

13.4.5 Record of accidents and dangerous occurrences

13.4.5.1 The safety officer must maintain a record of all accidents and dangerous occurrences in accordance with procedures in the ship's safety management system. On a ship where no safety officer is appointed, this duty falls to the Company. These records must be made available on request to any safety representative, the master or to any person duly authorised by the Secretary of State.

13.4.6 Duty to stop dangerous work

Reg. 16(1)9f

13.4.6.1 The safety officer has a duty to stop any work in progress which they reasonably believe may cause an accident and immediately inform the master (or a nominated deputy) who is responsible for deciding when work can safely be resumed.

13.4.6.2 This does not apply to an emergency action to safeguard life even though that action itself may involve a risk to life. The safety officer is not required by these regulations to carry out their duties to inspect, keep records or make recommendations at a time when emergency action to safeguard life or the ship is being taken.

13.4.6.3 The safety officer should also encourage other seafarers to stop any work that the seafarer reasonably believes could cause an accident.

13.5 Powers of safety representatives

13.5.1 Unlike the safety officer, the safety representative has powers not duties, although membership of the safety committee imposes certain obligations.

13.5.2 Safety representatives may, with the agreement of the safety officer, participate in investigations and inspections carried out by the

safety officer or, after notifying the master or a nominated deputy, may carry out their own investigation or inspection.

13.5.3 They may also make representations to the Company or the relevant employer on potential hazards and dangerous occurrences, and to the master, Company or employer on general health and safety matters, such as the findings of the risk assessment, health and safety training, and the introduction of new technology.

13.5.4 They may request, through the safety committee, that the safety officer undertakes an investigation and reports back to them, and may inspect any of the records the safety officer is required to keep under the regulations. They should ensure that they see all incident reports submitted to the MAIB under the accident reporting regulations (see section 13.3.8.4).

13.6 Advice to safety representatives

13.6.1 Safety representatives should be familiar with the relevant safety regulations and guidance for UK ships, regulations, marine notices and guidance issued by the MCA.

13.6.2 The effectiveness of safety representatives will depend to a large extent on good cooperation between them, the Company, other employers, the master, heads of department and safety officer.

13.6.3 Safety representatives should:

- put forward their views and recommendations in a firm but reasonable and helpful manner;
- be sure of the facts;
- be aware of the legal position; and
- be conscious of what is reasonably practicable.

13.6.4 Having made recommendations, they should request to be kept informed of any follow-up actions taken, or the reasons why such action was not possible.

13.6.5 If a safety representative finds that their efforts are being obstructed, or they are denied facilities, they should bring the matter to the attention of the safety officer or of the master through the safety committee. It should be the aim to settle any difficulties on board ship or through the relevant employer or the Company. If this proves impossible, the problem should be referred to the trade union or to the MCA.

13.7 Advice to safety committees

13.7.1 The safety committee is a forum for consultation between the master, safety officials and others of matters relating to health and safety. It may be used by individual employers for consultation with the Company and seafarers. Its effectiveness will depend on the commitment of its members, in particular that of the master. Because of its broad membership, and with the master as its chairman, the committee has the means to take effective action in all matters which it discusses other than those requiring the authorisation of the Company and individual employers. Safety committee meetings should not be used for the purposes of instruction or training.

13.7.2 The frequency of meetings will be determined by circumstances, but the committee should meet regularly, taking into account the pattern of operation of the ship and the arrangement for manning and with sufficient frequency to ensure continuous improvement in safety. In particular, a meeting should also be held after any serious incident or accident on the ship, if the normal meeting is not due within a week.

13.7.3 An agenda (together with any associated documents and papers, and the minutes of the previous meeting) should be circulated to all committee members in sufficient time to enable them to digest the contents and to prepare for the meeting.

13.7.4 If there is a particularly long agenda, it may be better to hold two meetings in fairly quick succession rather than one long one. If two meetings are held, priority at the first meeting should, of course, be given to the more urgent matters.

13.7.5 The first item on the agenda should always be the minutes of the previous meeting. This allows any correction to the minutes to be recorded and gives the opportunity to report any follow-up action taken.

13.7.6 The last item but one should be 'any other business'. This enables last-minute items to be introduced, and prevents the written agenda being a stop on discussion. Any other business should be limited to important issues that have arisen since the agenda was prepared. All other items should be submitted for inclusion in the agenda of the next meeting.

13.7.7 The last item on the agenda should be the date, time and place of the next meeting.

13.7.8 Minutes of each meeting should record concisely the business discussed and conclusions reached. A copy should be provided to each committee member. They should be agreed as soon after the meeting as possible, or amended if necessary, and then agreed under the first agenda item of the following meeting (see section 13.7.5).

13.7.9 A minutes file or book should be maintained, together with a summary of recommendations recording the conclusions reached, in order to provide a permanent source of reference and so ensuring continuity should there be changes in personnel serving on the committee.

13.7.10 All seafarers should be kept informed on matters of interest which have been discussed, e.g. by posting summaries or extracts from the minutes on the ship's noticeboards. Suggestions may be stimulated by similarly posting the agenda in advance of meetings.

13.7.11 Relevant extracts of agreed minutes should be forwarded through the master to the Company and, where appropriate, individual employers, even when the matters referred to have already been taken up with them. A record of response or action taken by the Company should be maintained.

13.8 Accident investigation

S.I. 2012/1743

13.8.1 The investigation of accidents and incidents plays a very important part in safety. It is by the identification and study of accidents principally through the MAIB's accident reporting system that similar events may be prevented in future.

MGN 458(M+F)

13.8.2 Marine guidance note MGN 458(M+F) provides guidance on how to comply with the statutory requirements.

*S.I. 1997/2962,
Reg. 16(1)(b)*

13.8.3 The master is responsible for the statutory reporting of accidents and dangerous occurrences covered by the regulations. Where a safety officer is on board, however, it is their statutory duty to investigate every such incident and it is expected that the master will rely extensively on the results and record of the safety officer's investigation when completing their report. The various stages of the typical investigation might proceed as follows:

- When an incident occurs, priority must be given to the safety of the injured and of those assisting them, and to the immediate safety of the area. When sufficient help is available, however, the safety officer should, if possible, avoid involvement with the rescue operation and concentrate on establishing the immediate facts concerning the incident.

- First, the names should be recorded – and addresses in case of non-crew personnel – of all those present in the vicinity of the incident. Not all are likely to be witnesses to the actual incident but this can be ascertained later. The position of the injured should be noted and marked, and the use and condition of any protective clothing, equipment or tools, etc. likely to have been in use. Any portable items that might have some relevance to the investigation should be put into safe storage. Sketches and photographs are often useful.
- When the injured have been removed, the safety officer should carry out a more detailed examination at the scene of the incident, watching out for any changes that might have occurred since the incident and any remaining hazards.

13.8.4 The points to look out for will depend on the circumstances. For example, after an incident during boarding, the following should be noted:

- Compliance with control measures identified by the risk assessment.
- The type of access equipment in use.
- The origin of the access equipment, e.g. ship's own, provided from shore.
- The condition of the access equipment itself, noting particularly any damage such as a broken guardrail or rung. The position and extent of any damage should be examined so that it may be compared with witnesses' statements, and it should be noted whether the damage was present before, or occurred during or as a result of the incident. (If the damage was present before the incident it might have been potentially dangerous but it may not necessarily have been a factor in the particular incident.)
- Any effect of external factors on the condition of the equipment, e.g. ice, water or oil on the surface.
- The deployment of the equipment, i.e. the location of the quayside and shipboard ends of the equipment.
- The rigging of the equipment, the method of securing, the approximate angle of inclination.
- The use of ancillary equipment (safety net, lifebuoy and lifeline, lighting).
- The safety of shipboard and quayside approaches to the equipment, e.g. adequate guardrails, obstructions and obstacles.

- Any indication of how the incident might have happened, but remember that subsequent interviews with witnesses must be approached with an open mind.
- The weather conditions at the time.
- Distances where these are likely to be helpful or relevant.

13.8.5 Interviews of witnesses should take place as soon as possible after the incident when memories are still fresh. There may be people who were not actually witnesses but who may nevertheless have valuable contributions to make, e.g. a seafarer who was present when an order was given. These persons should not be overlooked. If it is not possible for some reason to interview a particular person, they should be asked to send the safety officer their own account of the incident.

13.8.6 The actual interview should be carried out in an informal atmosphere designed to put the witness at their ease. To start with, the safety officer should explain the purpose of the interview and obtain some details of the witness's background. It is important to keep any personal bias out of the interview. The witness should be asked to relate the event in their own way with as few interruptions as possible. The accuracy of what is said should be tested. There may, for example, be discrepancies between the account of one witness and those of other witnesses, between different parts of a statement, or with the safety officer's own observations, which the safety officer may want to query. Leading questions implying an answer should be avoided, as should simple questions requiring only a yes/no answer which save the witness from thinking about what they are saying. Finally, the safety officer should go over the statement with the witness to ensure that it has been accurately recorded.

13.8.7 Statements for signature by the witness should be prepared as quickly as possible but if the witness changes their mind about signing a statement, it should be annotated by the safety officer that it has been prepared on the basis of an interview with the witness who had subsequently declined to sign it or comment further. Where the witness asks for extensive alterations to the original statement a fresh statement may have to be prepared, but the original statement should be annotated by the safety officer and retained.

13.8.8 It is helpful to adopt a standard format for statements by incident witnesses. A suggested format is at Annex 13.2.

13.8.9 It is worth emphasising the importance of distinguishing between facts and opinions. Facts can normally be supported by evidence whereas opinions are personal beliefs. An investigation must depend on the facts gathered but opinions can be helpful in pursuing a particular line of enquiry and should not be disregarded.

13.8.10 Any record of incidents and dangerous occurrences (see section 13.4.5.1) should at least contain:

- details of incidents/dangerous occurrences/investigations/complaints/inspections;
- date;
- persons involved;
- nature of injuries suffered;
- all statements made by witness;
- any recommendations/representations; and
- any action taken.

13.8.11 Additionally, it is suggested that it should contain:

- a list of witnesses, addresses, positions and occupations;
- the whereabouts of original signed statements made by witnesses;
- the date when the accident/dangerous occurrence reports were sent to the MAIB if applicable;
- a list of items collected, why and where stored; and
- an index.

13.8.12 The record should be kept with the ship because it must be made available on request to the safety representative and safety committee, if any. It is also a necessary item of reference for safety officers on board the ship. If the ship is sold and remains on the UK register, the record should be transferred with the ship. Where the ship becomes a foreign ship the record should be retained by the original owners.

Blank page

Annex 13.1 Checklist for safety officer's inspection

The following are examples of questions that the safety officer should consider. This is not intended to be an exhaustive list, and should be varied according to the particular design or conditions on a particular ship.

Means of access/safe movement

- Are means of access, if any, to the area under inspection (particularly ladders and stairs), in a safe condition, well lit and unobstructed?
- If any means of access is in a dangerous condition, for instance when a ladder has been removed, is the danger suitably blocked off and have warning notices been posted?
- Is access through the area of inspection both for transit and working purposes clearly marked, well lit, unobstructed and safe?
- Are fixtures and fittings over which seafarers might trip or which project (particularly overhead, thereby causing potential hazards), suitably painted, cushioned or marked?
- Is any gear that has to be stowed within the area suitably secured?
- Are all guardrails in place, secure and in good condition?
- Are all openings through which a person could fall suitably fenced?
- If portable ladders are in use, are they properly secured and at a safe angle?

Working environment

- Is the area safe to enter?
- Are lighting levels adequate?
- Is the area clear of rubbish, combustible material, spilled oil, etc.?
- Is ventilation adequate?
- Are seafarers adequately protected from exposure to noise where necessary?
- Are dangerous goods and substances left unnecessarily in the area or stored in a dangerous manner?
- Are loose tools, stores and similar items left lying around unnecessarily?

Working conditions

- Is machinery adequately guarded where necessary?
- Are any necessary safe operating instructions clearly displayed?
- Are any necessary safety signs clearly displayed?
- Are permits to work used when necessary?
- Are seafarers working in the area wearing any necessary protective clothing and equipment?
- Is that protective clothing and equipment in good condition and being used correctly?
- Is there any evidence of defective plant or equipment and if so what is being done about it?
- Is the level of supervision adequate, particularly for inexperienced seafarers?
- What practicable safety improvements could be made?

General

- Are all statutory regulations and company safety procedures being complied with?
- Is the safety advice in publications such as this Code, merchant shipping notices, etc. being followed where possible?
- Can the seafarers in the area make any safety suggestions?
- Have any faults identified in previous inspections been rectified?

Annex 13.2 Voluntary statement

Relating to an accident on board/name of ship/official number
..... on/date of accident/at/time of accident.

Particulars of witness

Name:

Rank and occupation:

Home address of crew members:

.....
.....
.....
.....

Address of employment of others:

.....
.....
.....
.....

Statement of witness

I make this statement voluntarily, having read it before signing it and believing the same to be true.

Signature of witness:

Date: Time:

Particulars of interviewer

Name:

Rank:

Blank page

CHAPTER 14

PERMIT TO WORK SYSTEMS

14.1 Introduction

14.1.1 Based on the findings of the risk assessment, appropriate control measures should be put in place to protect those who may be affected. This chapter covers permits to work, which are formal records to confirm that control measures are in place when particular operations are being carried out.

14.1.2 In this chapter and its annexes, any reference to a 'competent person' means a person designated and authorised for the task covered by a permit to work under the safety management system, and 'authorised officer' means a person designated and authorised for the purposes of issuing and closing permits to work under the safety management system.

14.2 Permit to work systems

14.2.1 There are many types of operation on board ship when the routine actions of one person may inadvertently endanger another, or when a series of action steps needs to be taken to ensure the safety of those engaged in a specific operation. In all instances, it is necessary, before the work is done, to identify the hazards and then to ensure that they are eliminated or effectively controlled. Ultimate responsibility rests with the Company to see that this is done.

14.2.2 The permit to work system consists of an organised and predefined safety procedure. A permit to work does not in itself make the job safe, but contributes to measures for safe working.

14.2.3 The safety management system for individual ships will determine when permit to work systems should be used, and the form of the permit to work. In using a permit to work, the following principles apply:

- The permit should be relevant and as accurate as possible. It should state the location and details of the work to be done, the nature and results of any preliminary tests undertaken, the measures undertaken to make the job safe and the safeguards that need to be taken during the operation.

- The permit should specify the period of its validity (which should not exceed 24 hours) and any time limits applicable to the work that it authorises.
- Only the work specified on the permit should be undertaken.
- Before signing the permit, the authorised officer should ensure that all measures specified as necessary have in fact been taken, or procedures are in place.
- The authorised officer retains responsibility for the work until they have either closed the permit or formally transferred it to another authorised officer who should be made fully conversant with the situation. Anyone who takes over from the authorised officer, either as a matter of routine or in an emergency, should sign the permit to indicate transfer of full responsibility.
- The competent person responsible for carrying out the specified work should countersign the permit to indicate their understanding of the safety precautions to be observed.
- On completion of the work, the competent person should notify the authorised officer and get the permit closed.
- The competent person carrying out the specified work should not be the same person as the authorised officer.

14.2.4 Annex 14.1 gives examples of permits to work for various types of activity. The examples in this annex show different approaches: sections 14.1.1 and 14.1.2 show permits to work which record that safety measures have been put in place before the work commences (dangerous (enclosed) spaces and work at height); section 14.1.3 hands the site over to the competent person carrying out the work, and sets out the safety measures that need to be put in place. This second type should only be used when alternative safety procedures are in place to ensure that measures have been carried out before work begins. These examples may be adapted to the circumstances of the individual ship or the particular job to be carried out, in the light of the risk assessment.

14.3 Sanction to test systems

14.3.1 A sanction to test may be required when additional controls are needed for the testing of high-risk systems, such as high-voltage systems. Where required, a sanction to test should be issued in an identical manner to a permit to work. A sanction to test should not be issued on any apparatus on which a permit to work is still in force, or on which another sanction to test is in force.

14.3.2 A sanction to test should be issued when testing operations require the removal of the circuit main earth. Note: maintenance and repair cannot be carried out under a sanction to test.

14.3.3 Annex 14.2 gives an example of a sanction to test for testing work carried out on electrical high-voltage systems **over** 1000 volts. The example shows the headings for each section and each section's requirements. These should be adapted to the circumstances of the individual ship or ship's electrical high-voltage system, or the particular job to be carried out, in light of the risk assessment.

Blank page

Annex 14.1 Permits to work

Permits to work would normally be required for the following categories of work:

- entry into dangerous (enclosed) space;
- gas testing/equipment;
- hot work;
- working at height/over the side;
- general electrical (under 1000 volts);
- electrical high voltage (over 1000 volts);
- working on deck during adverse weather; and
- lifts, lift trunks and machinery.

This list is not exhaustive. Permits to work, following a similar format, may be required and developed for other categories of work.

Blank page

Annex 14.1.1

PERMIT TO WORK: ENTRY INTO DANGEROUS (ENCLOSED) SPACE

Note (i): The authorised officer should insert the appropriate details when the sections for other work or additional precautions are used.

Note (ii): The competent person should tick each applicable box as they make their check.

Note (iii): This permit to work contains five sections.

SECTION A – Scope of work

Location (name of space)

Plant apparatus/identification (designation of machinery/equipment)

.....

Work to be done (reason for entry)

.....

Permit issued to (name of competent person carrying out work or in charge of the work party)

.....

This permit is valid: from hours Date

to hours

SECTION B – Checklists

Has a risk assessment been carried out for the proposed work? Y/N

Has a toolbox talk been carried out? Y/N

No conflict with any other permit to work in force? Y/N

B1 – Pre-entry preparation

To be completed by the authorised officer

Checklist	Checked
1. Space thoroughly ventilated.	
2. Atmosphere tested and found safe.	
3. Space secured for entry (verified all isolations, lock outs and tag outs are in place for safe entry and work).	
4. Testing equipment available for regular checks while space is occupied and after breaks.	
5. Arrangements for ventilation for duration of permit to work.	
6. Adequate access and lighting.	
7. Rescue and resuscitation equipment available at entrance.	
8. Competent person in attendance at entrance.	
9. Relevant officer of the watch advised of planned entry.	
10. Communication arrangements agreed between attendant and those entering, including emergency signals.	
11. Emergency and evacuation procedures agreed and in place.	
12. All equipment to be used of appropriate type.	
13. Personal protective equipment to be used: safety helmet, safety harness as necessary.	

B2 – Pre-entry checklist

To be completed by each person entering the space

	Names of persons entering the space			
I have received instructions and authorisation from the authorised officer to enter the dangerous space.				
Section 1 of this permit has been completed by the authorised person.				
I have agreed and understand the communication procedures.				
I have agreed upon a reporting interval of minutes.				
Emergency and evacuation procedures have been agreed and are understood.				
I have witnessed the testing of the atmosphere within the space and am satisfied it is safe to enter.				
I am aware that the space must be vacated immediately in the event of ventilation failure or if the atmosphere test shows a change from agreed safe criteria.				
Signatures of persons entering the space				

B3 – Breathing apparatus and other equipment

To be completed by the competent person

Checklist	Checked
1. Those entering the space familiar with any breathing apparatus to be used	
2. Breathing apparatus tested and found satisfactory	
3. Means of communication tested and found satisfactory	
4. Those entering wearing rescue harnesses and lifelines where practicable	

B4 – Other work/additional precautions

To be completed by the authorised officer

Checklist	Checked

SECTION C – Certificate of checks

I confirm that I am satisfied that all precautions have been taken and that safety arrangements will be maintained for the duration of the work.

Competent person

Name Signature

Time Date

I am satisfied that all precautions set out in B1 to B4 have been taken and that safety arrangements will be maintained for the duration of the work.

Authorised officer

Name Signature

Time Date

Note: After signing the receipt, this permit to work should be retained by the competent person in charge at the place where the work is being carried out until the work is complete and the clearance section signed.

SECTION D – Personnel entry

Names	Time in	Time out

SECTION E – Cancellation of certificate

The work has been completed*/cancelled* and all persons under my supervision, materials and equipment have been withdrawn.

Competent person

Name Signature

Time Date

* Delete words not applicable and where appropriate state:

The work is complete*/incomplete* as follows: [description]

.....

.....

.....

.....

The worksite has been inspected; I accept that all persons, material and equipment have been withdrawn, and the site is secured against entry*/ safe for entry*.

Authorised officer

Name Signature

Time Date

*Delete words not applicable.

Blank page

Annex 14.1.2

PERMIT TO WORK: WORKING AT HEIGHT/OVER THE SIDE

Note (i): The authorised officer should indicate the sections applicable by ticks in the left-hand boxes next to headings, deleting any subheading not applicable.

Note (ii): The authorised officer should insert the appropriate details when the sections for other work or additional precautions are used.

Note (iii): The competent person should tick each applicable right-hand box as they make their check.

Note (iv): This permit to work contains four sections.

SECTION A – Scope of work

Location (name of space)

.....

Plant apparatus/identification (designation of machinery/equipment)

.....

Work to be done [description]

.....

Permit issued to (name of competent person carrying out work or in charge of the work party)

.....

This permit is valid: from hours Date.....
to hours

NOTE: The validity of this permit to work should not exceed 24 hours.

SECTION B – Checklists

To be completed by the authorised officer (AO) and competent person (CP)

B1 – Preliminary checklist

Checklist	Checked (AO)	Checked (CP)
Has a risk assessment been carried out for the proposed work?		
Has a toolbox talk been carried out?		
No conflict with any other permit to work in force?		

B2 – Preparation checklist

Checklist	Checked (AO)	Checked (CP)
1. Duty officer informed		
2. Warning notices posted		
3. On-deck supervisor identified		
4. Equipment in good order		
5. Work on funnel: <ul style="list-style-type: none">• advise duty engineer;• isolate whistle.		
6. Work near radar scanners/radio aerials: <ul style="list-style-type: none">• isolate radar and scanner/radio room notified;• notices placed to stop the use of radar/radio.		
7. Work over the side: <ul style="list-style-type: none">• advise duty officer/engineer;• lifebuoy and lifeline ready.		
8. Personal protective equipment to be used: <ul style="list-style-type: none">• safety helmet;• safety harness and line attached to a strong point;• lifejacket;• other (please list).		
9. All tools to be raised and lowered secured on a lanyard/belt or in a bag.		
10. Has a plan been agreed and necessary equipment been put in place to achieve an effective rescue?		

SECTION C – Certificate of checks

I confirm that I am satisfied that all precautions have been taken and that safety arrangements will be maintained for the duration of the work and no attempt will be made by me or people under my charge to work on any other apparatus or in any other area.

Competent person

Name Signature
Time Date

I am satisfied that all precautions have been taken and that safety arrangements will be maintained for the duration of the work and no attempt will be made by me or people under my charge to work on any other apparatus or in any other area.

Authorised officer

Name Signature
Time Date

Note: After signing the receipt, this permit to work should be retained by the competent person in charge at the place where the work is being carried out until work is complete and the clearance section signed.

SECTION D – Cancellation of certificate

The work has been completed*/cancelled* and all persons under my supervision, materials and equipment have been withdrawn and warned that it is no longer safe to work on the apparatus detailed in this permit to work.

Competent person

Name Signature
Time Date

* Delete words not applicable and where appropriate state:

The work is complete*/incomplete* as follows: [description] (*Delete words not applicable)

.....
.....
.....
.....

The worksite has been inspected; I accept that all persons, material and equipment have been withdrawn and all persons warned that it is no longer safe to work on the apparatus detailed in this permit to work.

Authorised officer

Name Signature

Time Date

Annex 14.1.3

PERMIT TO WORK: GENERAL

VESSEL:											
AREA OF VESSEL:	PTW No: _____ / _____										
1. AUTHORISED OFFICER (AO):											
TIME:											
1.1 WORK DESCRIPTION (Please use BLOCK CAPITALS at all times except for signatures)											
Category of work (delete as required): HOT WORK/DANGEROUS SPACE WORK/WORK AT HEIGHT/ OVERSIDE WORK/GAS TESTING/EQUIPMENT											
Equipment to be worked on:											
Proposed work description:	<table border="1"> <tr> <th>COMPETENT PERSONS (CPs)</th> <th></th> </tr> <tr> <td>1</td> <td>4</td> </tr> <tr> <td>2</td> <td>5</td> </tr> <tr> <td>3</td> <td>6</td> </tr> <tr> <td></td> <td>7</td> </tr> </table>	COMPETENT PERSONS (CPs)		1	4	2	5	3	6		7
COMPETENT PERSONS (CPs)											
1	4										
2	5										
3	6										
	7										
Requested by (AO):	Signature: _____ Company: _____										

HAS RISK ASSESSMENT OF THIS TASK BEEN CONDUCTED? YES/NO – If no, **STOP THE JOB** until one is provided.
 HAS TOOLBOX TALK BEEN CONDUCTED? YES/NO HAS LOLER LIFTING PLAN BEEN CONDUCTED? YES/NO

2. PRECAUTIONS: Delete as required. Leave applicable item clear.

2.1 GENERAL			
(a) Inform other personnel who may be affected	YES/NO	(d) Rope off area	YES/NO
(b) Provide additional access, lighting, ventilation	YES/NO	(e) Post warning signs	YES/NO
(c) Visit to work site required	YES/NO	(f) Provide radio communications	YES/NO
2.2 PERSONAL PROTECTIVE EQUIPMENT REQUIRED			
Safety helmet	YES/NO	Coveralls	YES/NO
Safety boots	YES/NO	Gloves	YES/NO
Safety goggles	YES/NO	Safety harness	YES/NO
Other (list)			
2.3 HOT WORK		2.4 ENTRY INTO DANGEROUS (ENCLOSED) SPACES	
(a) Fire watch required	YES/NO	CONTACT MASTER	(a) Isolate from systems
(b) Safety watch during breaks	YES/NO		(b) Risk of oxygen deficiency
(c) Portable extinguisher to be at site	YES/NO		(c) Need to wear breathing apparatus/mask
(d) Shielding to prevent spread of sparks	YES/NO		(d) Provide additional ventilation
2.5 ISOLATION/ENERGY RELEASE PROTECTION			(e) Provide additional lighting
If isolation is required, lock down to be confirmed by chief engineer.			(f) Rescue plan provided *required*
Certificate to be provided and attached to permit to work.			(g) Portable monitor in use by entry team *required*
Certificate number: _____			(h) Appoint crew standby person
If third-party action, crew standby person must be additional to contractor standby person.			
2.6 WORKING AT HEIGHT/OVER THE SIDE			
Have alternative means for task been explored?	YES/NO	Rescue plan provided *required*	YES/NO
Work crew at least two people *required*	YES/NO	Continuous comms est. with bridge	YES/NO
Life ring with line readily available	YES/NO	Warning notices posted	YES/NO
Suitable bridge equipment to be locked out			
2.7 CONTRACTOR CONTROL OF WORK SITE			
I hereby sign that I agree to take complete control of (insert work site) _____ at the time of issuance of this permit to work and have satisfied myself that all required isolations are in place to secure this site. – NO CREW IS NOW TO ENTER THIS SITE.			
AO TO SIGN TO TAKE CONTROL OF SITE		Signed (AO): _____	
2.8 GAS TESTING/EQUIPMENT			
Vessels: Serial no. _____ Calib. date: _____ Gas testing result: _____			
If outside contractor, certificate must be attached.			
2.9 ENSURE NO CONFLICT WITH ANY OTHER PERMIT Completed by (AO signature): _____			
3. AUTHORISATION BY AO (as named in Part 1)			
Authority is hereby given for the work detailed in Part 1.1 to be carried out, provided the precautions in Part 2 are strictly observed.			
AUTHORISED BY (AO):		SIGNATURE:	
TIME:		DATE:	

PERMIT IS VALID FOR A PERIOD OF 12 HOURS FROM THE TIME AUTHORISED, UNLESS EXTENDED UNDER SECTION 5

4. ACCEPTANCE

We accept the conditions of the permit as stated above and will inform all competent persons involved in the work of the precautions to be taken. We will display a copy of the permit at the work site at all times during the task.	
ACCEPTED BY CP:	SIGNATURE:
ACCEPTED BY AO:	SIGNATURE:
TIME:	DATE:

5. EXTENSION (Site should be inspected prior to extension being granted)

Permit must not exceed 24 hrs	Signature
First extension granted at: 6hrs on:	
Second extension granted at: 6hrs on:	

6. COMPLETION (Delete as required for 6.1)

6.1 Work is complete	YES/NO	All tools/apparatus have been removed and secured	YES/NO
Site is in a safe condition	YES/NO	Normal operations may be resumed	YES/NO
Name (AO):	Signature:	Date:	Time:
6.2 The worksite has been inspected; I accept that all equipment is operational, the site is safe, and that I take back full control of this site.			
CLOSED BY (AO):	Signature:	Date:	Time:

Annex 14.2 Sanction to test: electrical high voltage (over 1000 volts)

Note (i): The authorised officer should indicate the sections applicable by ticks in the left-hand boxes, deleting any subheading not applicable.

Note (ii): The authorised officer should insert the appropriate details when the sections for other work or additional precautions are used.

Note (iii): The competent person should tick each applicable right-hand box as they make their check.

Note (iv): This sanction to test contains six sections.

SECTION A – Scope of work

Location (name of space)

.....

Plant apparatus/identification (designation of machinery/equipment)

.....

Work to be done [description]

.....

Sanction to test issued to (name of competent person carrying out work or in charge of the work party)

.....

This sanction to test is valid: from hours Date
to hours

NOTE: The validity of this sanction to test should not exceed 24 hours.

SECTION B – Checklists

To be completed by the authorised officer (AO) and competent person (CP)

B1 – Preliminary checklist

Checklist	Checked (AO)	Checked (CP)
Has a risk assessment been carried out for the proposed work?		
Has a toolbox talk been carried out?		
No conflict with any other permit to work in force?		

B2 – Isolation data checklist

Checklist	Checked (AO)	Checked (CP)
1. The above apparatus is dead and has been isolated from the system at the following points: [description]		
2. Circuit main earths have been applied to the equipment at the following points. These earths may be removed and replaced to your instructions. [description]		
3. Safety locks [detail location fitted and identify lock set]		
4. Additional precautions to avoid danger have been taken by: [description]		
5. Caution/danger notices have been applied at all points of isolation as listed above and safety signs positioned as follows:		
6. Presence of other hazards including list of other relevant permits to work/ sanctions to test:		
7. Treat all other apparatus and areas as dangerous. Further precautions:		

SECTION C – Certificate of checks

I accept responsibility for carrying out the work on the apparatus detailed in this sanction to test and no attempt will be made by me or by persons under my charge to work on any other apparatus or in any other area. I confirm that the above equipment is dead and isolated from all live conductors and connected to earth.

I am satisfied that all precautions set out in Section B have been taken and that safety arrangements will be maintained for the duration of the work.

Safety key no. Received/applied*
(*Delete word not applicable)

Competent person

Name Signature

Time Date

I confirm that the above equipment is dead and isolated from all live conductors and connected to earth. I am satisfied that all precautions set out in Section B have been taken and that safety arrangements will be maintained for the duration of the work.

Safety key no. Received/applied*
(*Delete word not applicable)

Authorised officer

Name Signature

Time Date

Note: After signing the confirmation, this sanction to test should be retained by the competent person in charge at the place where the work is being carried out until the work is complete and the clearance section signed.

SECTION D – Clearance of sanction to test

The work for which this sanction to test has been completed*/cancelled* and all persons under my supervision have been withdrawn and warned that it is no longer safe to work on the apparatus detailed in this sanction to test.

All work materials and equipment have been removed.

Competent person

Name Signature

Time Date

Safety key no. Received/applied*

The worksite has been inspected; I accept that all persons, material and equipment have been withdrawn, and the site is secured against entry*/ safe for entry.*

(*Delete words not applicable)

SECTION E – Cancellation of sanction to test

This sanction to test is cancelled.

Authorised officer

Name Signature

Time Date

Safety key no. Received/applied*

* Delete words not applicable and where appropriate state:

The work is complete*/incomplete* as follows: [description]

.....
.....
.....
.....

CHAPTER 15

ENTERING DANGEROUS (ENCLOSED) SPACES

*IMO Resolution
A.1050(27)*

15.1 Introduction

15.1.1 An enclosed space is one that:

- has limited openings for entry and exit;
- has inadequate ventilation; and
- is not designed for continuous worker occupation.

Any enclosed space deprived of regular and constant ventilation may become a 'dangerous space'. The UK regulations define a dangerous space as: 'Any enclosed or confined space in which it is foreseeable that the atmosphere may at some stage contain toxic or flammable gases or vapours, or be deficient in oxygen, to the extent that it may endanger the life or health of any person entering that space.'

15.1.2 Some spaces may be a dangerous space only temporarily, perhaps due to the type of cargo carried or work to be undertaken, e.g. a compartment during spray painting.

15.1.3 Any enclosed space is potentially life threatening and every precaution should be taken both prior to entry and while inside. The dangers may not be readily apparent and, despite testing, isolated areas with very low oxygen content or small concentrations of toxic gases may exist. N.B.: A single inhalation with a 5% oxygen content may result in instantaneous loss of consciousness and subsequent death. Similarly, small concentrations of a toxic substance may result in loss of consciousness and subsequent death. Therefore, it is essential that all necessary precautions are taken including a risk assessment and the completion of a permit to work.

15.1.4 Based on the findings of the risk assessment, appropriate control measures should be put in place to protect anyone who may enter an enclosed space. Procedures (such as systems of work, permits to work and emergency procedures) should be part of a ship's safety management system. This chapter identifies control measures for entry into enclosed spaces.

15.1.5 A dangerous space may not necessarily be enclosed on all sides, e.g. ships' holds may have open tops but the nature of the cargo makes the atmosphere in the lower hold dangerous. Such places are not usually

considered to be dangerous spaces but the atmosphere may become dangerous because of a change in the condition inside or in the degree of enclosure or confinement, which may occur intermittently, e.g. in diving bells or saturation chambers. Personnel need to exercise caution before entering any space on board a ship that has not been opened for some time. Examples of such spaces are:

- cargo spaces;
- double bottoms;
- fuel tanks;
- ballast tanks;
- cargo pump rooms;
- cargo compressor rooms;
- cofferdams;
- chain lockers;
- void spaces;
- duct keels;
- inter-barrier spaces;
- boilers;
- engine crankcases;
- engine scavenge air receivers;
- CO₂ rooms;
- battery lockers;
- sewage tanks; and
- adjacent connected spaces, e.g. cargo space access ways.

This is not an exhaustive list, and awareness of potential risks is necessary for all spaces on board ship. If in any doubt, any such space should be regarded as dangerous and appropriate action taken.

15.1.6 Any dangerous (enclosed) spaces on board ship should be identified using risk assessment and kept under review. It is recommended that an inventory is made of any enclosed spaces that seafarers may enter where there is any likelihood that they might become dangerous. The inventory should record the characteristics of the space, the likely hazard and measures to prevent entry unless safety procedures are followed. Any difficulties inherent in rescue from the space should also be considered, and solutions identified, so that in the event of an

emergency, the crew is in the best position to respond quickly. This inventory should be reviewed regularly.

15.1.7 In addition:

- if there is any unexpected reduction in or loss of the means of ventilating spaces that are usually continuously or adequately ventilated, such spaces should also be dealt with as dangerous spaces; and
- when it is suspected that there could be a deficiency of oxygen in any space, or that toxic gases, vapours or fumes could be present, then such a space should be considered to be dangerous.

15.1.8 Entrances to all unattended dangerous spaces on a ship should be kept locked or secured against entry. Any hatches to readily accessible enclosed spaces should be marked as the entrance to a dangerous space. When the space is open for work to be carried out, an attendant should be posted or a barrier and warning sign put in place. As far as possible, work should be arranged in such a way that no one has to enter the space.

15.1.9 All crew should be given on-board training and familiarisation with the risks of entry into dangerous spaces on board. Training should include as a minimum:

- identification of the hazards likely to be faced during entry into enclosed spaces;
- knowledge of the procedures for assessment of the space;
- knowledge of the procedures for safe entry; and
- recognition of the signs of adverse health effects caused by exposure to hazards during entry.

15.2 Duties and responsibilities of a competent person and an authorised officer

*IMO Resolution
A.1050(27)*

15.2.1 A competent person means a person with sufficient theoretical knowledge and practical experience to make an informed assessment of the likelihood of a dangerous atmosphere being present or subsequently arising in the space, including taking measurements of the atmosphere.

15.2.2 An authorised officer means a person authorised to permit entry into an enclosed space and with sufficient knowledge of control and elimination of hazards, and of the procedures to be established and complied with on board, to be able to ensure that the space is safe for entry. (International Maritime Organization (IMO) Resolution A.1050(27) refers to this person as the 'responsible officer').

15.2.3 On the basis of their risk assessment, the authorised officer should decide the procedures to be followed for entry into a potentially dangerous space. These will depend on whether the assessment shows that:

- there is minimal risk to the life or health of a person entering the space then or at any future time;
- there is no immediate risk to health and life but a risk could arise during the course of work in the space; or
- the risk to life or health is immediate.

15.2.4 Where the assessment shows that there is no immediate risk to health or life but that a risk could arise during the course of the work in the space, the precautions described in sections 15.3 to 15.10 should be taken as appropriate.

15.2.5 Where the risk to health or life is immediate, then the additional requirements specified in section 15.11 are necessary.

15.2.6 On inland waterway vessels, harbour craft and other small ships operating close to shore, seafarers may never be expected to enter a dangerous space, because shore-based companies or personnel may be engaged to carry out any inspection or other work in dangerous spaces. In such cases, some of the requirements of this chapter may not apply, e.g. the requirement to have atmosphere-testing equipment on board the ship at all times, and the requirement for entry drills. However, **all** seafarers should have on-board training to help them recognise the risks from dangerous spaces and to familiarise them with any applicable procedures. When the competent person and authorised officer are shore-based personnel, no entry into a potentially dangerous space should be permitted until such suitably qualified persons are present.

15.2.7 When shore-side personnel are contracted to enter a dangerous space on a ship in a UK port, the requirements of the Confined Spaces Regulations 1997 apply. While the master retains overall authority for any activity on board their ship, the employer of the shore-side team is responsible to ensure compliance with the Confined Spaces Regulations 1997. The Company should satisfy themselves that the shore-side personnel have sufficient training; equipment and arrangements for rescue in accordance with the Confined Spaces Regulations 1997, Approved Code of Practice, or suitable equivalent arrangements. Once a permit to work has been issued, the shore-side personnel should take responsibility for the operation and for rescue arrangements. It is not sufficient to rely on emergency services for rescue arrangements, although they should still be notified in the event of any such emergency; nor should the ship's crew be designated to provide back-up support.

15.3 Precautions before entering a dangerous space

15.3.1 The following precautions should be taken as appropriate before a potentially dangerous space is entered, so as to make the space safe for entry without breathing apparatus and to ensure it remains safe whilst persons are within the space.

- A competent person should make an assessment of the space and an authorised officer to take charge of the operation should be appointed, see section 15.3.
- The potential hazards should be identified – see section 15.4.
- The space should be prepared, vented and secured for entry – see section 15.5.
- The atmosphere of the space should be tested – see section 15.6.
- A permit to work system should be used – see section 15.7.
- Procedures for preparation and entry should be agreed – see sections 15.8 and 15.9.
- Emergency procedures should be in place.

15.3.2 When the procedures listed in the previous paragraph have been followed and it has been established that the atmosphere in the space is or could be unsafe, then the additional requirements (including the use of breathing apparatus appropriate to the type and size of the space), as specified in section 15.11 should also be followed.

15.3.3 In addition to pre-entry testing of the atmosphere, it is recommended that any person entering a potentially dangerous space should wear a personal atmosphere-monitoring device ('multimeter') capable of detecting oxygen deficiency, carbon monoxide, toxic gases and explosive atmospheres. It is important to recognise that carrying a personal atmosphere monitor is no substitute for pre-entry testing.

15.4 Identifying potential hazards

15.4.1 In carrying out their assessment, the competent person must take into account any cargo previously carried in the space, ventilation, the coating of the space, the degree of corrosion and any other relevant factors. The factors affecting adjacent spaces may be different from those affecting the space to be entered, but may affect the atmosphere in the space to be entered.

Oxygen deficiency

15.4.2 If an empty tank or other confined space has been closed for a time, the oxygen content may have been reduced for a number of reasons. The following are examples only:

- Rusting may have occurred due to oxygen combining with steel.
- Oxygen-absorbing chemicals may have been present.
- Oxygen-absorbing cargoes may have been carried, including:
 - grain, grain products and residues from grain processing (such as bran, crushed grain, crushed malt or meal) hops, malt husks and spent malt;
 - oilseeds, products from oil seeds (such as seed expellers, seed cake, oil cake and meal);
 - copra;
 - wood in such forms as packaged timber, round wood logs, pulpwood, props (pit props and other prop-wood) woodchips, wood-shavings, wood pellets and sawdust;
 - jute, hemp, flax, sisal, kapok, cotton and other vegetable fibres, empty bags, cotton waste, animal fibres, animal and vegetable fabric, wool waste and rags;
 - fish, fishmeal and fish-scrap;
 - guano;
 - sulphidic ores and ore concentrates;
 - charcoal, coal lignite and coal products;
 - direct reduced iron (DRI);
 - dry ice;
 - metal wastes and chops, iron swarf, steel and other turnings, borings, drillings, shavings, filings and cuttings; and
 - scrap metal.
- Gases from volatile cargoes may have displaced the oxygen in tanks.
- Hydrogen may have been produced in a cathodically protected cargo tank used for ballast.
- Oxygen may have been displaced by the use of carbon dioxide or other fire-extinguishing or preventing media, or inert gas in the tanks or inter-barrier spaces of tankers or gas carriers.
- Nitrogen or another inert gas may have been used to purge tanks.

Oxygen-enriched atmosphere

15.4.3 This may arise from:

- leaks from damaged or poorly maintained hoses, pipes and valves;
- leaks from poor connections;
- opening valves deliberately or accidentally;
- not closing valves properly after use;
- using an excess of oxygen in welding, flame cutting or a similar process; or
- poor ventilation where oxygen is being used.

Because oxygen is odourless, colourless and tasteless, an oxygen-enhanced atmosphere cannot be easily detected by human senses. However, because oxygen aids combustion, even a small increase in the concentration of oxygen in the air produces an increased risk of fire – including spontaneous combustion – or explosion.

Toxicity of oil

15.4.4 Hydrocarbon gases are flammable as well as toxic and may be present in fuel or cargo tanks that have contained crude oil or its products.

15.4.5 Hydrocarbon gases or vapours may also be present in pump rooms and cofferdams, duct keels or other spaces adjacent to cargo tanks due to the leakage of cargo.

15.4.6 The components in the vapour of some bunker oils and oil cargoes, such as benzene and hydrogen sulphide, are very toxic.

Toxicity of other substances

15.4.7 Some of the cargoes carried in bulk, liquid, gas or packaged form may be toxic or liable to emit toxic gas; appropriate testing for toxic gas should be carried out as per 15.6.11.

15.4.8 There is the possibility of leakage from drums of chemicals or other packages of dangerous goods where there has been mishandling, incorrect stowage, or damage due to heavy weather.

15.4.9 Inert gas does not support life. In addition, trace components that are often present in the inert gas, such as carbon monoxide, sulphur dioxide, nitric oxide and nitrogen dioxide, are very toxic.

15.4.10 The interaction of vegetable or animal oils, sewage or slops from drilling operations with sea water may lead to the release of hydrogen sulphide, which is very toxic.

15.4.11 Hydrogen sulphide or other toxic gases may be generated where the residue of grain or similar cargoes permeates into or chokes bilge-pumping systems.

15.4.12 The chemical cleaning, painting or repair of tank coatings may involve the release of solvent vapours.

15.4.13 Fumigants may have been used on cargoes in the space (see section 21.7).

Flammability

15.4.14 Flammable vapours may still be present in cargo or other tanks that have contained oil products or chemical or gas cargoes.

15.4.15 Cofferdams and other spaces that are adjacent to cargo and other tanks may contain flammable vapours, should there have been leakage into the space.

Other hazards

15.4.16 Although the inhalation of contaminated air is the most likely route through which harmful substances enter the body, some chemicals can be absorbed through the skin.

15.4.17 Some of the cargoes in bulk, liquid, gas or packaged form are irritants or corrosive if permitted to come into contact with the skin; appropriate testing should be carried out as per 15.6.11.

15.4.18 Disturbance of rust, scale or sludge residues of cargoes of animal, vegetable or mineral origin, or of water that could be covering such substances, may lead to the release of toxic or flammable gases.

15.5 Preparing and securing the space for entry

15.5.1 When opening the entrance to a potentially dangerous space, precautions should be taken in case pressurised or unpressurised vapour or gases are released from it. The space should be thoroughly ventilated, either by natural or mechanical means, and then tested (see section 15.6) to ensure that all harmful gases have been removed and no pockets of oxygen-deficient atmosphere remain. Any vented gases should be discharged away from the area, thereby not contaminating the immediate area of the entry point to the space or other spaces.

15.5.2 The space should be isolated and secured against the ingress of dangerous substances by blanking off pipelines or other openings and by closing valves, in accordance with the risk assessment and on-board procedures. Valves should then be secured in the closed position, or some other means used to indicate that they are not to be opened. Remote-operated valves should, where practicable, have their remote

actuators inhibited with notices placed locally and on the relevant controls. The officer on watch should be informed.

15.5.3 Where necessary, any sludge or other deposit liable to give off fumes should be cleaned out. This may in itself lead to the release of gases, and precautions should be taken (see section 15.11).

15.5.4 Compressed oxygen should not be used to ventilate any space.

15.5.5 When appropriate, pumping operations or cargo movements should be suspended when entry is being made into a dangerous space.

15.6 Testing the atmosphere of the space

15.6.1 From January 2016, ships are required to carry atmosphere-testing equipment. This must be capable of measuring concentrations of oxygen, flammable gases or vapours, hydrogen sulphide and carbon monoxide prior to entry.

15.6.2 Manufacturers' instructions for atmosphere testing equipment should have clearly defined calibration requirements. Where the operation of the ship permits access more frequently than the manufacturer's recommended calibration renewal period (e.g. ferry services), the calibration equipment may be kept ashore, and arrangements for calibration should be clear from the ship's SMS. Otherwise, calibration equipment should be carried on board.

15.6.3 Testing should be carried out by remote means before entry and at regular intervals thereafter. Testing of a space should be carried out using properly calibrated and maintained equipment, and only by competent persons trained in the use of the equipment.

15.6.4 If testing by remote means is not possible (e.g. where remote double-bottom tanks have to be entered), it should be assumed that the atmosphere is hazardous until proven otherwise. The person selected to enter the space to test the atmosphere should only do so in accordance with the additional precautions specified in section 15.11, which include the wearing of breathing apparatus. Testing of the space should be carried out at different levels.

15.6.5 Personal monitoring equipment should not be used as a means of determining whether a dangerous space is safe prior to entry. This equipment is designed for personal use only, to provide a warning against oxygen deficiency, toxic gases and explosive atmospheres whilst the wearer is in the space.

MSC.1 Circ 1477

Testing for oxygen deficiency

15.6.6 The normal level of oxygen in the atmosphere is 20.8%. Any variation from that may indicate a problem and should be investigated further. For example, when the oxygen reading is 20%, consideration should be given to further testing for toxic gases, where appropriate, because toxic gases may have displaced some oxygen (see section 15.6.11). Once other risks are discounted, a steady reading of at least 20% oxygen by volume should be obtained before entry is permitted.

15.6.7 A combustible gas indicator cannot be used to detect oxygen deficiency.

Testing for flammable gases and vapours

15.6.8 The combustible gas element of the detector detects the amount of flammable gas or vapour in the air. An instrument capable of providing an accurate reading at low concentrations should be used to judge whether the atmosphere is safe for entry.

15.6.9 The combustible gas element of the detector is calibrated on a standard gas. When testing for other gases and vapours, reference should be made to the calibration curves supplied with the instrument. Particular care is required should accumulations of hydrogen and methane be suspected, because high levels may affect the accuracy of the device.

15.6.10 In deciding whether the atmosphere is safe to work in, a 'nil' reading on a suitably sensitive combustible gas indicator is desirable but, where the readings have been steady for some time, up to 1% of the lower flammable limit may be accepted, e.g. for hydrocarbons in conjunction with an oxygen reading of at least 20% by volume.

Testing for toxic gases

15.6.11 The presence of certain gases and vapours on chemical tankers and gas carriers is detected by fixed or portable gas or vapour detection equipment. It is difficult to measure the quantities of these toxic products at the safe level without specialised equipment and trained personnel. If this equipment is not available for use, the period of gas freeing should be considerably extended. Where measurement can be carried out, the readings obtained by this equipment should be compared with the workplace exposure limit (WEL) for the contaminant given in the latest edition of the Health and Safety Executive (HSE) Guidance Note EH40, which can be found on the HSE website. (Workplace exposure limits are sometimes known as occupational exposure limits (OELs) and are given in international industry safety guides.) Workplace exposure limits provide guidance for the level of exposure to toxic substances. Entry should not be authorised if the atmosphere measures over 50% of the WEL. However, it is necessary to know for which chemical a test is being

made in order to use the equipment correctly, and it is important to note that not all chemicals may be tested by these means. Tests for specific toxic contaminants, such as benzene, should be undertaken depending on the nature of the previous contents of the space. The safety data sheets for previous cargoes or fuel carried should be referred to.

15.6.12 When a toxic chemical is encountered for which there is no means of testing, then the additional requirements specified in section 15.11 should also be followed.

15.6.13 If a separate combustible gas indicator is used, this is not suitable for measuring levels of gas at or around its workplace exposure limit, where there is solely a toxic, rather than a flammable, risk. This level will be much lower than the flammable limit, and the indicator may not be sufficiently sensitive to give accurate readings.

Blank page

15.7 Use of control systems

15.7.1 Entry into a dangerous space should be planned in advance and use should be made of a permit to work system. Details of the arrangements to be followed in a permit to work system are described in Chapter 14, Permit to work systems (a sample permit to work can be found in Annex 14.1).

15.7.2 For situations for which a well-established safe system of work exists, a checklist may exceptionally be accepted as an alternative to a full permit to work, provided that the principles of the permit to work system are covered and the risks arising in the dangerous space are low.

15.7.3 No person should enter a dangerous space unless authorised to do so by an authorised officer. Only the minimum number of trained personnel required to do the work should be authorised to enter. Those entering must be wearing appropriate clothing. All equipment used must be in good working condition and inspected before use.

15.8 Safety precautions before entry

15.8.1 The space and its access areas should be adequately illuminated.

15.8.2 No source of ignition should be taken or put into the space unless the authorised officer is satisfied that it is safe to do so.

15.8.3 A rescue plan should be in place (see section 15.14). In all cases, rescue and resuscitation equipment should be positioned ready for use at the entrance to the space. A risk assessment should identify what rescue equipment may be required for the particular circumstances but, as a minimum, this should include:

- appropriate breathing apparatus, with fully charged spare cylinders of air;
- lifelines and rescue harnesses;
- torches or a lamp (approved for use in a flammable atmosphere, if appropriate); and
- a means of hoisting an incapacitated person from the confined space, if appropriate.

15.8.4 Breathing equipment may be bulky and limit movement in the space. Before entry is permitted, it should be established that entry with breathing apparatus is possible. Any difficulty of movement within any part of the space, or any problems if any incapacitated person had to be removed from the space (as a result of breathing apparatus or lifelines or rescue harnesses being used), should be considered. Risks should be minimised or entry prohibited.

15.8.5 Lifelines should be long enough for the purpose and capable of being firmly attached to the harness, but the wearer should be able to detach them easily should they become tangled. They should not be relied upon as the sole means of recovering a casualty from a space.

15.8.6 When necessary, a rescue harness should be worn to make it easier to recover a casualty in the event of an accident.

15.8.7 In addition to rescue harnesses, wherever practicable, hoisting equipment should be used. Hoisting equipment should be attended by personnel stationed at the entrance who have been trained in how to pull an unconscious person from a dangerous space.

15.8.8 At least one competent person, with appropriate equipment, should be posted to remain as an attendant at the entrance to the space whilst it is occupied.

15.8.9 An agreed and tested system of communication should be established:

- between any person entering the space and the attendant at the entrance; and
- between the attendant at the entrance to the space and the officer on watch.

15.9 Procedures and arrangements during entry

15.9.1 Ventilation should continue during the period that the space is occupied and during temporary breaks. In the event of a failure of the ventilation system, any personnel in the space should leave immediately.

15.9.2 The atmosphere should be tested periodically whilst the space is occupied and personnel should be instructed to leave the space should there be any deterioration of the conditions. Testing should be carried out more frequently if there is any possibility of change in the conditions in the space. Should a personal gas detector give an alarm, everybody should leave the space immediately.

15.9.3 If unforeseen difficulties or hazards develop, the work in the space should be stopped and everybody should leave the space so that the situation can be re-assessed. Permits should be withdrawn and only re-issued, with any appropriate revisions, after the situation has been re-assessed.

15.9.4 If any personnel in a space feel in any way adversely affected, they should give the pre-arranged signal to the attendant standing by the entrance and immediately leave the space.

15.9.5 Should an emergency occur, the general (or crew) alarm should be sounded so that back-up is immediately available to the rescue team. Under no circumstances should the attendant enter the space.

15.9.6 If air is being supplied through an airline to the person in the space, a check should be made immediately that the air supply is being maintained at the correct pressure.

15.10 Procedures on completion

15.10.1 On expiry of the permit to work, everyone should leave the space and the entrance to the space should be closed or otherwise secured against entry or, alternatively, where the space is no longer a dangerous space, declared safe for normal entry.

15.11 Additional requirements for entry into a space where the atmosphere is suspect or known to be unsafe

15.11.1 If the atmosphere is considered to be suspect or unsafe to enter, then the space should only be entered if it is essential for testing purposes, for the safety of life or of the ship, or for the working of the ship. Breathing apparatus should always be worn (see section 15.13). The number of persons entering the space should be the minimum compatible with the work to be performed.

15.11.2 Except in the case of an emergency, or where impracticable because movement in the space would be seriously impeded, two air supplies should be available. While working, the wearer should use the continuous supply provided from outside the space. If it becomes necessary to change over to the self-contained supply, the user should immediately exit from the space.

15.11.3 Precautions should be taken against any disruption to the air supply while the individual is inside the enclosed space. Special attention should be given to supplies originating from the engine room.

15.11.4 Where remote testing of the space is not reasonably practicable, or where a brief inspection only is required, a single air supply may be acceptable provided that the wearer of breathing apparatus is so situated that they can be removed from the space immediately in the case of an emergency.

15.11.5 When appropriate, portable lights and other electrical equipment should be of a type approved for use in a flammable atmosphere.

15.11.6 Should there be a risk of chemicals, whether in liquid, gaseous or vapour form, coming into contact with the skin and/or eyes, then protective clothing should be worn.

15.12 Training, instruction and information

15.12.1 The Company should provide any necessary training, instruction and information to seafarers in order to ensure that the requirements of the Entry into Dangerous Spaces Regulations are complied with. This should include:

- recognition of the circumstances and activities likely to lead to the presence of a dangerous atmosphere;
- the hazards associated with entry into dangerous spaces, and the precautions to be taken;
- the use and maintenance of equipment and clothing required for entry into dangerous spaces; and
- instruction and drills in rescue from dangerous spaces.

S.I. 1988/1638

15.12.2 It is recommended that all seafarers whose duties may involve entry into enclosed spaces should attend a dedicated course for entry into enclosed spaces.

15.13 Breathing apparatus and resuscitation equipment

15.13.1 No one should enter a space where the atmosphere is unsafe or suspect without wearing breathing apparatus that is designed for the purpose and which they are trained to use, even to rescue another person.

15.13.2 As described in section 15.11.2, breathing apparatus for those working in a dangerous space will usually comprise a continuous supply from outside the space and a self-contained supply to enable the wearer to escape to a safe atmosphere in the event of difficulty with, or failure of, the continuous supply. It should not be necessary to remove any part of the equipment or any protective clothing to change over to the self-contained supply. Air-purifying respirators are not suitable because they cannot supply clean air from an independent source.

15.13.3 Equipment for use with two air supplies may consist of:

- conventional self-contained breathing apparatus of the open circuit compressed air type that is approved to EN 137:2006 and has been additionally tested for use with an airline connection; or
- compressed airline breathing apparatus incorporating an emergency self-contained supply. The compressed airline breathing apparatus should be of the demand-valve type and approved to BS EN 14593 or BS EN 14594 or, for self-rescue purposes, to BS 1146:2005 (or equivalent standard). The emergency self-contained supply should comply with the relevant parts of the appropriate standard.

The capacity of the self-contained supply should be sufficient for the wearer to escape to a safe atmosphere. When determining this capacity it should be recognised that, under stress or in difficult conditions, the wearer's breathing rate may be in excess of the nominal breathing rate of 40 litres per minute.

15.13.4 The authorised officer should make sure that the supply of air from outside the space is continuous and available only to those working in the space. Pipelines or hoses supplying air should be placed so that they are not likely to be damaged or distorted so that supply might be interrupted. If the purpose for which such airlines are used is not immediately apparent to personnel not engaged in the entry, then notices should be posted at appropriate positions. When a mechanical pump is being used, it should frequently be checked carefully to ensure that it continues to operate properly. Any air pumped directly into a pipeline or put into reserve bottles must be filtered and should be as fresh as possible. Pipelines or hoses used to supply air should be thoroughly blown through to remove moisture and freshen the air before connection to breathing apparatus and face masks. It is essential that where the air supply is from a compressor sited in a machinery space, the engineer of the watch is informed so that the compressor is not shut down until the work is completed.

15.13.5 Everyone likely to use breathing apparatus must be instructed by a competent person in its proper use.

15.13.6 The authorised officer and the person about to enter the space should undertake the full pre-wearing check and donning procedures recommended in the manufacturer's instructions for the breathing apparatus. In particular, they should check that:

- there will be sufficient clean air at the correct pressure;
- low-pressure alarms are working properly;
- the face mask fits correctly against the user's face so that, combined with pressure of the air coming into the mask, there will be no ingress of oxygen-deficient air or toxic vapours when the user

inhales (it should be noted that facial hair or spectacles may prevent the formation of an air-tight seal between a person's face and the face mask);

- the wearer of the breathing apparatus understands whether or not their air supply may be shared with another person and, if so, is also aware that such procedures should only be used in an extreme emergency; and
- when work is being undertaken in the space, the wearer should keep the self-contained supply for use if there is a failure of the continuous supply from outside the space.

15.13.7 When in a dangerous space:

- no one should remove their own breathing apparatus; and
- breathing apparatus should not be removed from a person unless it is necessary to save their life.

15.13.8 It is recommended that resuscitators of an appropriate kind should be provided where any person may be required to enter a dangerous space. Where entry is expected to occur at sea, the ship should be provided with appropriate equipment. Otherwise entry should be deferred until the ship has docked and use can be made of shore-side equipment.

Maintenance of equipment for entry into dangerous spaces

15.13.9 All breathing apparatus, rescue harnesses, lifelines, resuscitation equipment and any other equipment provided for use in, or in connection with, entry into dangerous spaces, or for use in emergencies, should be properly maintained, inspected periodically and checked for correct operation by a competent person, and a record of the inspections and checks should be kept. All items of breathing apparatus should be inspected for correct operation before and after use.

15.13.10 Equipment for testing the atmosphere of dangerous spaces, including oxygen meters, should be kept in good working order and, where applicable, regularly serviced and calibrated. Manufacturers' recommendations, which should always be stored with the equipment, should be complied with at all times.

15.14 Preparation for an emergency

15.14.1 On all SOLAS ships, an emergency drill for rescue from an enclosed space should be carried out every two months. Regular drills are recommended on other ships where the crew may be required to enter an enclosed space. Drills should as a minimum include:

- checking and use of personal protective equipment required for entry;
- checking and use of communication equipment and procedures;
- checking and use of instruments for measuring the atmosphere in enclosed spaces;
- checking and use of rescue equipment and procedures; and
- instructions in first-aid and resuscitation techniques.

15.14.2 For every entry to a dangerous space, a rescue plan should be in place. Suitable rescue equipment should be available at the entry to the space, and roles allocated in the event of an emergency arising. Selection of such equipment should take into account the depth and volume of the space, the size of the access way, the potential distance of the casualty from the point of entry and the resources available to assist in the rescue.

Emergency rescue arrangements

15.14.3 In the event of an alarm being raised, no one should enter any dangerous space to attempt a rescue without taking suitable precautions for their own safety. Failure to do so will put the would-be rescuer's life at risk and almost certainly prevent the person they intended to rescue being brought out alive. Many multiple fatalities have occurred as a result of individuals recklessly attempting a rescue without taking adequate precautions.

15.14.4 Should an emergency occur, the general (or crew) alarm should be sounded so that back-up is immediately available to the rescue team. Under no circumstances should the attendant enter the space.

15.14.5 Once help has arrived, the situation should be evaluated and the rescue plan put into effect. An attendant should remain outside the space at all times to ensure the safety of those entering the space to undertake the rescue.

15.14.6 Once the casualty is reached, the checking of the air supply must be the first priority. Unless they are gravely injured, they should be removed from the dangerous space as quickly as possible.

15.14.7 Self-contained breathing apparatus that is specifically suited for such applications must be worn. If it is found that it is not possible to enter a tank wearing a self-contained breathing apparatus, the bottle

harness may be removed and passed through the access but the face mask must always be worn. Care should be taken to ensure that the harness does not drop onto or pull on the supply tube and dislodge the face mask.

15.14.8 An emergency escape breathing device (EEBD) is **not** suitable for rescue. This is a supplied air or oxygen device, designed only to be used for escape from a compartment that has a hazardous atmosphere. It should not be worn by a rescuer to attempt a rescue of persons in any circumstances.

Entering a dangerous (enclosed) space

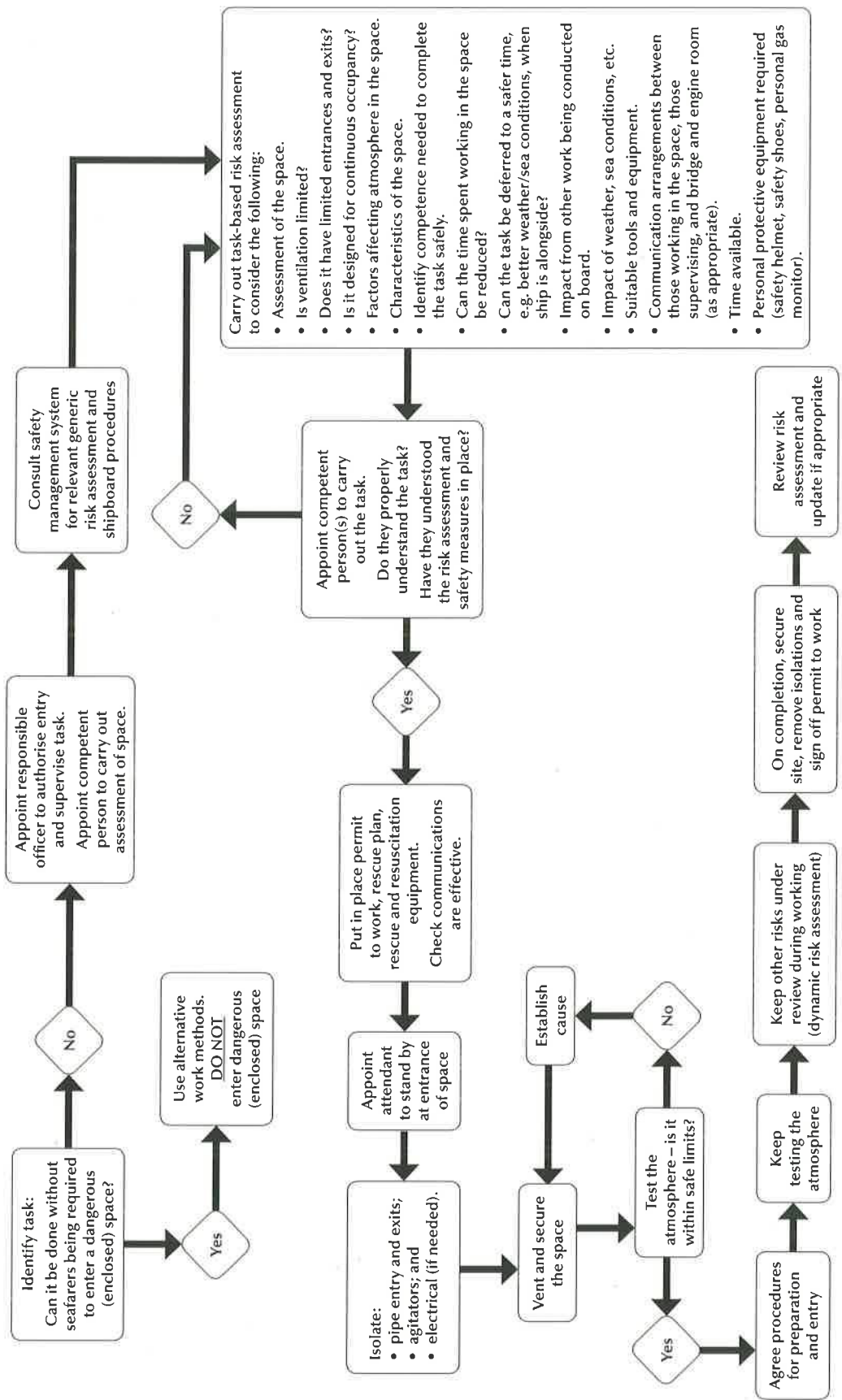

Blank page

CHAPTER 16

HATCH COVERS AND ACCESS LIDS

16.1 Introduction

16.1.1 Based on the findings of the risk assessment, appropriate control measures should be put in place to protect those workers whose health and safety may be put at risk by the operation of hatch covers and access lids. This chapter identifies some areas that may require attention in respect of these.

16.1.2 When handling hatch covers and access lids, appropriate personal protective equipment should be worn at all times.

16.2 General

16.2.1 Any hatch covering used on a ship should be of sound construction and material, of adequate strength for the purpose for which it is used, free from patent defect and properly maintained.

16.2.2 A hatch covering should not be used unless it can be removed and replaced without endangering any person.

16.2.3 Information showing the correct replacement position should be clearly marked, except where hatch coverings are interchangeable or incapable of being incorrectly replaced. No hatch cover should be replaced contrary to the ship's plan showing the correct replacement position.

16.2.4 A hatch should not be used unless the hatch covering has been completely removed or, if not completely removed, is properly secure.

16.2.5 Before a vessel departs, all weather deck hatch covers should be secured in the correct closed position. Whilst the vessel is at sea, they should be regularly inspected to ensure that integrity is maintained.

16.2.6 All hatch covers should be properly maintained. Defective or damaged covers should be replaced/repared as soon as possible.

16.2.7 Where covers and beams are still used, they should only be used if they are a good fit and overlap their end supports to an extent that is adequate but not excessive.

16.2.8 All personnel involved with the handling and/or operation of hatch covers should be properly instructed in their handling and operation. All stages of opening or closing hatches should be supervised by a responsible person.

16.2.9 When hatches are open, the area around the opening and in the hatchways should be appropriately illuminated and guardrails erected where necessary. Guardrails should be tight, with stanchions secured in position, and properly maintained.

16.2.10 When lifting appliances are used, they should be attached to hatch covers from a safe position and without personnel being exposed to any danger.

16.2.11 No loads should be placed over or work take place on any section of hatch cover unless it is known that the cover is properly secured and can safely support the load.

16.2.12 Partly opened unguarded hatches should never be temporarily covered with anything that could conceal the opening; this would present a serious hazard for any person walking across the hatch.

16.2.13 Unless hatches are fitted with coamings to a height of at least 760 mm (30 inches), they should be securely covered or fenced to a height of 1 metre (39 inches) when not in use for the passage of cargo.

16.2.14 Hatch covers should only be used in accordance with the manufacturer's instructions.

16.3 Mechanical hatch covers

16.3.1 The manufacturer's instructions for the safe operation, inspection, maintenance and repair of the type of mechanical hatch cover fitted should always be followed.

16.3.2 During operations, personnel should keep clear of the hatches and the cover stowage positions. The area should be kept clear of all items that might foul the covers or the handling equipment.

16.3.3 Special attention should be paid to the trim of the vessel when handling mechanical covers. The hatch locking pins or preventers of rolling hatch covers should not be removed until a check wire is fast to prevent premature rolling when the tracking is not horizontal.

16.3.4 Hatch wheels should be kept greased and free from dirt and the coaming runways and drainage channels kept clean. The rubber sealing joints should be properly secured and in good condition so as to provide a proper weather-tight seal.

16.3.5 All locking and tightening devices should be secured in place on a closed hatch at all times when at sea. Securing cleats should be kept greased. Cleats, top-wedges and other tightening devices should be checked regularly whilst at sea.

16.3.6 Hatch covers should be properly secured immediately after closing or opening. They should be secured in the open position with chain preventers or by other suitable means. No one should climb on to any hatch cover unless it is properly secured.

16.3.7 Except in the event of an emergency endangering health or safety, no person should operate a hatch covering that is power-operated unless authorised to do so by a responsible ship's officer.

16.4 Non-mechanical hatch covers

16.4.1 Each non-mechanical hatchway should be provided with an appropriate number of properly fitting hatch covers, pontoons or slab hatches, which are adequately marked to show the correct replacement position.

16.4.2 Pontoon hatches and hatch slabs should be handled with care and properly stowed, stacked so as not to endanger or impede the normal running of the vessel.

16.4.3 When a crane or derrick is used to handle pontoons or slab hatches, it should be positioned directly over them to lessen the risk of violent swinging once the weight has been taken.

16.4.4 Appropriate gear of adequate strength should be specially provided for the lifting of pontoons and slab hatches. The crane or winch should be operated by a competent person under the direction of a ship's officer or other experienced person.

16.4.5 Hatch covers should not be removed or replaced until a check has been made that all persons are out of the hold or clear of the hatchway.

16.5 Non-mechanical manually handled hatch covers

16.5.1 Each non-mechanical manually handled hatchway should be provided with an appropriate number of properly fitting beams and hatch covers, pontoons or slab hatches, which are adequately marked to show the correct replacement position. For wooden hatch covers, an adequate number of properly fitting tarpaulins, batten bars, side wedges and locking bars should be provided so that the hatch will remain secure and weather tight for all weather conditions.

16.5.2 Manually handled hatch covers should be capable of being easily lifted by two people. Such hatch covers should be of adequate thickness and strength and provided with handgrips. Wooden hatch boards should be strengthened by steel bands at each end. One person should not attempt to handle hatch covers unaided unless the covers are designed for single-handed operation.

16.5.3 Hatch boards, hatch beams and tarpaulins should be handled with care and properly stowed, stacked and secured so as not to endanger or impede the normal running of the vessel. Hatch boards should be removed working from the centre towards the sides, and replaced from the sides towards the centre. Where tarpaulins are used, personnel should walk forwards and not backwards so they can see where they are walking.

16.5.4 When a crane or derrick is used to handle beams, it should be positioned directly over the beam to lessen the risk of violent swinging once the weight has been taken.

16.5.5 Appropriate gear of adequate strength should be specifically provided for the lifting of beams. Slings should be of adequate length, secured against accidental dislodgement while in use and fitted with control lanyards. The angle between arms of slings at the lifting point should not exceed 120°, in order to avoid undue stress. The crane or winch should be operated by a competent person under the direction of a ship's officer or other experienced person.

16.5.6 Beams and hatch covers remaining in position in a partly opened hatchway should be securely pinned, lashed, bolted or otherwise properly secured against accidental dislodgement.

16.5.7 Hatch covers and beams should not be removed or replaced until a check has been made that all persons are out of the hold or clear of the hatchway. Immediately before beams are to be removed, a check should be made that pins or other locking devices have been freed.

16.5.8 No one should walk out on a beam for any purpose.

16.5.9 Hatch covers should not be used in the construction of deck or cargo stages or have loads placed on them that are liable to damage them. Loads should not be placed on hatch coverings without the authority of a ship's officer.

16.6 Steel-hinged inspection/access lids

16.6.1 Inspection/access hatch lids should be constructed of steel or similar material, and hinged so they can be easily and safely opened or closed. Those on weather decks should be seated on watertight rubber

gaskets and secured weather tight by adequate dogs, side cleats or equivalent tightening devices.

16.6.2 When not secured, inspection/access hatch lids should be capable of being easily and safely opened from above and from below.

16.6.3 Adequate handgrips should be provided in accessible positions to lift inspection/access hatches by hand without straining or endangering personnel.

16.6.4 Heavy or inaccessible hatch lids should be fitted with counterweights so that they can easily be opened by one or two persons. Where a counterweight cannot be fitted due to inaccessibility, the hatch lids should be supplied with a purchase or pulley with eye-plates or ringbolts fitted in appropriate positions so that the hatch can be opened and closed without straining or endangering personnel.

16.6.5 Where hatch lids are fitted with a security device, they should be capable of being opened easily from below in the event of an emergency.

16.6.6 The hatch lids when open should be easily and safely secured against movement or accidental closing. Adequate locking pins, steel hooks or other means should be provided.

16.7 Access to holds/cargo/other spaces

16.7.1 Entry to holds/cargo/other spaces should only be undertaken on the authority of a responsible ship's officer, who should ensure prior to granting authority that the space has been adequately ventilated and, where appropriate, tested for noxious gases/oxygen content. All other appropriate pre-entry precautions should be undertaken (see Chapter 15, Entering dangerous (enclosed) spaces).

16.7.2 Entry should be made where at all possible through the permanent means of access. When this is not possible, portable ladders may be used (see section 17.3). Where necessary, lifelines and safety harnesses should be used.

Blank page

CHAPTER 17

WORK AT HEIGHT

17.1 Introduction

*S.I. 2010/332 and
MGN 410(M+F)*

17.1.1 Anyone working in a location where there is a risk of falling may be regarded as working at height. This includes undertaking work inside a tank, near an opening such as a hatch, or on a fixed stairway. Further guidance is contained in marine guidance note MGN 410(M+F).

17.1.2 Work at height should be subject to risk assessment, and suitable control measures should be taken to protect those who may be put at risk. Depending on the severity of the risk, a permit to work may be required (e.g. for working aloft).

17.2 General

17.2.1 Work should only be carried out at height if there is no reasonably practicable alternative to doing so. Where a reasonably practicable alternative does exist, it should be adopted. Where work must be carried out at height, the Company must ensure that such work is properly planned, appropriately supervised and carried out in as safe a manner as is reasonably practicable. Planning should include the carrying out of a risk assessment, which may include consideration of potential risks from falling objects or fragile surfaces and planning for emergency situations. Guidance on planning for emergency situations while working at height can be found in Annex 17.1.

17.2.2 Only competent persons should engage in any activity relating to work at height, or use of equipment for work at height, including the organisation, planning and supervision of such activities. Where a seafarer is being trained to undertake such work, they must be supervised by another seafarer who is competent to supervise and undertake that activity.

17.2.3 Personnel under 18 years of age, or with less than 12 months' experience at sea, should not work aloft unless it forms part of their planned training, and unless they are accompanied by a competent person or otherwise adequately supervised.

17.2.4 Work equipment should be selected that is fit for purpose and meets the requirements of Chapter 18, Provision, care and use of work equipment, of this Code. It should be used in accordance with safe procedures and good practice.

S.I. 2006/2183

17.2.5 Personnel working at a height may not be able to give their full attention to the job and, at the same time, guard themselves against falling. Proper precautions should, therefore, always be taken to ensure personal safety when work has to be done aloft or when working outboard. It must be remembered that the movement of a ship in a seaway and poor weather conditions, even when alongside, will add to the hazards involved in work of this type. A stage, ladder, scaffolding, bosun's chair or scaffold tower should be used when work is to be done beyond normal reach. Any equipment being used should be in a good state of repair.

17.2.6 Personnel working aloft should wear a safety harness with a lifeline or other arresting device at all times (see section 8.10). A safety net should be rigged where necessary and appropriate. Additionally, where work is done overside, a working lifejacket (personal flotation device) or buoyancy garments should be worn (see section 8.12) and a lifebuoy with sufficient line attached should be kept ready for immediate use. Personnel should be under observation from a person on deck.

17.2.7 Other than in emergency situations, personnel should not work overside whilst the vessel is under way. If such work has to be undertaken, lifeboats or rescue boats should be ready for immediate use. Any such work should be closely monitored/watched by a responsible person.

17.2.8 Before undertaking work near the ship's whistle, the officer responsible should ensure that it is isolated and that warning notices are posted on the bridge and in the machinery spaces.

17.2.9 Before undertaking work on the funnel, the officer responsible should inform the duty engineer to ensure that steps are taken to reduce as far as practicable the emission of steam, harmful gases and fumes.

17.2.10 Before undertaking work in the vicinity of radio aerials, the officer responsible should inform the radio room or person in charge of radio equipment so that no transmissions are made whilst there is a risk to personnel. A warning notice should be placed on the communications equipment or the equipment isolated.

17.2.11 Where work is to be done near the radar scanner, the officer responsible should inform the officer on watch so that the radar and scanner are isolated. A warning notice should be put on the radar equipment until the necessary work has been completed.

17.2.12 On completion of the work of the type just described, the person responsible should, where necessary, inform the appropriate person that the precautions taken are no longer required and that isolations and warning notices can be removed.

17.2.13 Work aloft should not be carried out in the vicinity of cargo working unless it is absolutely essential. Care must always be taken to avoid risks to anyone working or moving below. Suitable barriers should be erected and warning notices displayed.

17.2.14 Tools and stores should be sent up and lowered by line in suitable containers, which should be secured in place for stowage of tools or materials not presently being used. Tools should be secured by a lanyard, e.g. to the seafarer's wrist or harness, when in use. No one should place tools where they can be accidentally knocked down and may fall on someone below, nor should tools be carried in pockets from which they may easily fall.

17.2.15 Tools should be handled with extra care when hands are cold and greasy and where the tools themselves are greasy.

17.3 Portable ladders

MGN 410(M+F)

17.3.1 Working from ladders should be avoided as far as possible but, where necessary, personnel must use a safety harness with a lifeline secured above the work position, where practicable.

17.3.2 A portable ladder should only be used where no safer means of access is reasonably practicable. It is very important that the ladder is checked regularly by a competent person. Annex 17.2 (reproduced from MGN 410(M+F)) gives further guidance.

17.3.3 Wooden ladders should not be painted or treated so as to hide defects and cracks. When not in use, they should be stowed safely in a dry, ventilated space away from any heat source.

17.3.4 Portable ladders should be pitched at 75° from the horizontal, on a firm base, properly secured against slipping or shifting sideways and be so placed as to afford a clearance of at least 150 mm behind the rungs. Where practicable, the ladder should extend to at least 1 metre above any upper landing place, unless there are other suitable handholds.

17.3.5 When portable extending ladders are in use, there should be sufficient overlap between the extensions.

17.3.6 Personnel negotiating a ladder should use both hands, and not attempt to carry tools or equipment in their hands. When working, three points of contact with the ladder should be maintained (both feet and a handhold).

17.3.7 Planks should not be supported on rungs of ladders to be used as staging, nor should ladders be used horizontally for such purposes.

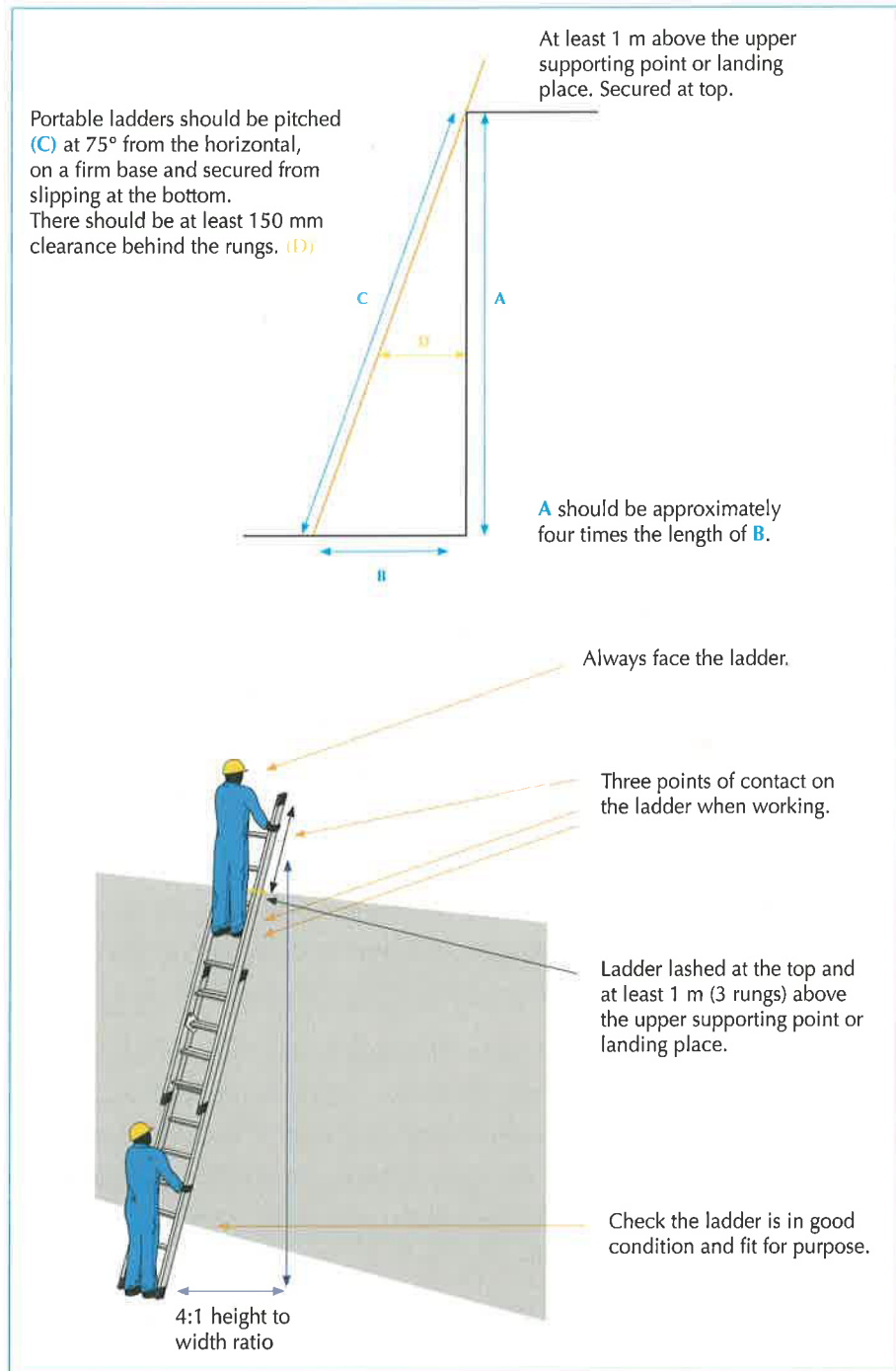

17.4 Cradles and stages

17.4.1 Cradles should be at least 430 mm (17 inches) wide and fitted with guardrails or stanchions with taut ropes to a height of 1 metre (39 inches) from the floor. Toe-boards add safety. Annex 17.3 (reproduced from MGN 410(M+F)) gives further guidance.

17.4.2 Planks and materials used for the construction of ordinary plank stages must be carefully examined to ensure adequate strength and absence of defects.

17.4.3 Wooden components of staging should be stowed in a dry, ventilated space and not subjected to heat.

17.4.4 Ancillary equipment, lizards, blocks and gantlines should be thoroughly examined before use.

17.4.5 When a stage is rigged overside, the two gantlines used in its rigging should be at least long enough to trail into the water to provide additional lifelines should a person fall. A lifebuoy and line should be kept ready nearby.

17.4.6 Gantlines used for working aloft should not be used for any other purpose and should be kept clear of sharp edges when in use.

17.4.7 The anchoring points for lines, blocks and lizards must be of adequate strength and, where practicable, be permanent fixtures to the ship's structure. Integral lugs should be hammer tested. Portable rails or stanchions must not be used as anchoring points. Any anchoring points should be treated as lifting points and should be inspected/tested in accordance with Chapter 19, Lifting plant and operations, of this Code.

17.4.8 Stages and staging that are not suspended should always be secured against movement. Hanging stages should be restricted against movement to the extent practicable.

17.4.9 In machinery spaces, staging and its supports should be kept clear of contact with hot surfaces and moving parts of machinery. In the engine room, a crane gantry should not be used directly as a platform for cleaning or painting, but can be used as the base for a stable platform if suitable precautions are taken.

17.4.10 Where personnel working from a stage are required to raise or lower themselves, great care must be taken to keep movements of the stage small and closely controlled.

17.4.11 Guidance for rail and trolley systems for overside working is in MGN 422(M).

17.5 Bosun's chair

17.5.1 When used with a gantline, the chair should be secured to it with a double-sheet bend and the end seized to the standing part with adequate tail. Annex 17.3 (reproduced from MGN 410(M+F)) gives further guidance.

17.5.2 Hooks should not be used to secure bosun's chairs unless they are of the type that, because of their special construction, cannot be accidentally dislodged, and have a marked safe working load that is adequate for the purpose.

17.5.3 On each occasion that a bosun's chair is rigged for use, the chair, gantlines and lizards must be thoroughly examined and renewed if there is any sign of damage. They should be load tested to at least four times the load they will be required to lift before a person is hoisted.

17.5.4 When a chair is to be used for riding topping lifts or stays, it is essential that the bow of the shackle, and not the pin, rides on the wire. The pin in any case should be seized.

17.5.5 When it is necessary to haul a person aloft in a bosun's chair, it is generally done only by hand rather than by using a winch. In the case of mast access on large sailing yachts, a winch may be used by a competent person, providing a risk assessment has been completed and effective safety measures put in place to control the risks identified.

17.5.6 If a seafarer is required to lower themselves while using a bosun's chair, they should first frap both parts of the gantline together with a suitable piece of line to secure the chair before making the lowering hitch. The practice of holding on with one hand and making the lowering hitch with the other is dangerous. It may be prudent to have someone standing by to tend the lines.

17.6 Working from punts

17.6.1 Punts should be stable and provided with suitable fencing. Unsecured trestles and planks should not be used to give additional height. Safety lines and a working lifejacket should be used.

17.6.2 Before a punt is put to use, the person in charge should have due regard to the strength of tides and other hazards, such as wash from passing vessels.

17.6.3 When work is to be done at or near the stern or near bow/stern thrusters, the person in charge should inform the duty deck and engineering officers so that equipment is isolated and/or warning notices placed in the engine room, on the bridge and at any local controls.

17.6.4 The duty engineer and deck officers should also be informed by the person in charge when personnel are working in the vicinity of ship's side discharges so that they are not used until the work is completed. Equipment should be isolated and/or notices to this effect should be attached to the relevant control valves and not removed until the work is completed.

17.7 Scaffolding, including scaffolding towers

17.7.1 Annex 17.4 (reproduced from MGN 410(M+F)) gives further guidance.

17.7.2 Only scaffolding of an approved design should be used and rigged in conformity with a generally recognised configuration. If necessary, a calculation of its strength should be carried out and recorded.

17.7.3 Care should be taken when assembling and dismantling the scaffold.

17.7.4 Great care should be taken to ensure the stability of the structure and safe access to it. If it is a mobile structure, it should be securely fixed to ensure that it cannot inadvertently move while in use.

17.7.5 Anyone rigging or dismantling scaffolding should have received adequate training.

17.7.6 Measures, such as adequate safety rails, should be incorporated to prevent the risk of persons or objects falling off.

17.7.7 Care must be taken to ensure that the safe working load of the structure is not exceeded.

Blank page

Annex 17.1 Emergency planning for work at height

MGN 410(M+F)

1. Planning should also take into account the possibility of emergencies occurring that result in workers requiring rescue from where they are working at height. Sources of available guidance are listed in Annex D of MGN 410(M+F) – note, in particular, the Work at Height Association guidance as regards rescue. In conjunction with the risk assessment, consideration must be given to circumstances that might occur when work is undertaken at height and how rescue could be achieved. The following questions may be a useful guide:
 - What type of emergency could occur requiring the rescue of a worker, e.g. is it likely to be a fall from height to the deck or into an open hold, a fall that leaves a worker suspended from a safety harness or from the equipment on which they were working, or might it even involve a full or partial collapse of that equipment?
 - Is access likely to be readily available to the worker or workers concerned should a rescue situation occur?
 - How difficult will it be to recover a fallen or suspended worker from a hold to deck level or to lower a fallen or suspended worker to deck level?
 - What level of competence will be required of those involved in the rescue?
 - Will any specialist equipment be required?
 - Are there any hazards that could potentially be encountered during the rescue, e.g. is the worker requiring rescue in an area where oxygen deficiency or other hazardous atmosphere could be a problem for rescuers?
 - Is appropriate protective equipment readily available to rescuers in situations referred to in the bullet point above?
 - Are rescuers, or others on board, appropriately trained in the provision of appropriate medical care to a worker who has fallen or become suspended whilst working at height?

Note: This list is only illustrative and should not be considered definitive.

2. It is understood that seafarers will wish to rescue a colleague in distress as quickly as possible. However, experience shows that undue haste can result in additional casualties, because appropriate safety precautions are not followed by potential rescuers before a rescue is attempted. Whilst, therefore, the aim should be to rescue the casualty as expeditiously as possible, the health and safety of the rescuers themselves should not be put at risk.

3. When a ship is in port, there may be a tendency to await the arrival of the local emergency services. However, there may be delays to the emergency service. It is, therefore, essential that appropriate procedures and measures are in place on board to deal with any emergencies and rescues that could potentially arise, whether at sea or in port. The aim in any situation requiring the rescue of a person suspended whilst working at height should be to rescue the suspended person, whether injured or uninjured, as safely and promptly as possible, having regard to all the circumstances including the health and safety of the rescuers.
4. A person left suspended at height in a harness for a significant period of time may suffer from symptoms like suspension syncope or suspension intolerance. This includes tingling in arms and legs and feelings of faintness.
5. During and after rescue, standard first-aid guidance should be followed. If a rescuer is unable to immediately release a conscious casualty from a suspended position, elevation of the legs by the casualty or the rescuer where safely possible may help prolong tolerance of suspension. Up-to-date guidance on the treatment of suspension syncope/intolerance is given on the Health and Safety Executive (HSE) website, along with 'Advice for first-aiders responding to harness suspension incidents'.

Annex 17.2 Requirements for ladders

1. A ladder shall be positioned so as to ensure its stability during use.
2. A suspended ladder shall be attached in a manner that:
 - makes it secure;
 - ensures it cannot be displaced; and
 - prevents it from swinging.

The last two bullet points do not apply to a rope ladder.

3. Portable ladders shall rest on footing that is stable, firm, of sufficient strength and of suitable size and composition safely to support the ladder so that its rungs or steps remain horizontal.

Where, owing to the movement of the ship, it is not reasonably practicable to ensure that the rungs or steps of a portable ladder remain horizontal, all appropriate measures to ensure the stability of the portable ladder shall be taken.

4. The feet of a portable ladder shall be prevented from slipping during use by:
 - securing the stiles at or near their upper or lower ends;
 - using an anti-slip device; or
 - any other arrangement of equivalent effectiveness.
5. A ladder used for access shall be long enough to protrude sufficiently above the place of landing to which it provides access, unless other measures have been taken to ensure a firm handhold.
6. No interlocking or extension ladder shall be used unless its sections are prevented from moving relative to each other while in use.
7. A mobile ladder shall be prevented from moving before it is stepped on.
8. A ladder shall be used in such a way that:
 - a secure handhold and secure support are always available to the user; and
 - the user can maintain a safe handhold when carrying a load by hand.

Blank page

Annex 17.3 Requirements for rope access and positioning techniques

Equipment should be inspected before each use, and thoroughly examined by a competent person at least every three months in accordance with a specified schedule.

1. A rope access or positioning technique shall only be used if:
 - subject to the next bullet point, it involves a system comprising at least two separately anchored ropes, of which one ('the working rope') is used as a means of access, egress and support and the other is a safety rope;
 - the seafarer is provided with and uses a suitable harness and is connected by it to the working rope and the safety rope;
 - the working rope is equipped with safe means of ascent and descent and has a self-locking system to prevent the seafarer falling should they lose control of their movements;
 - the safety rope is equipped with a mobile fall prevention system that is connected to and travels with the seafarer;
 - the working rope and the safety rope should take different leads;
 - ropes should be protected from right angles or sharp edges; and
 - the tools and other accessories to be used by the seafarer are secured to their harness or seat or by some other suitable means.
2. A rope access or positioning technique may involve a system comprising a single rope where:
 - the risk assessment has demonstrated that the use of a second line would entail higher risk to persons; and
 - appropriate measures have been taken to ensure safety.

Blank page

Annex 17.4 Requirements for scaffolding

1. Strength and stability calculations for scaffolding shall be carried out unless:
 - a note of the calculations, covering the structural arrangements contemplated, is available; or
 - the scaffolding is assembled in conformity with a generally recognised standard configuration.
2. Depending on the complexity of the scaffolding chosen, an assembly, use and dismantling plan shall be drawn up by a competent person. This may be in the form of a standard plan, supplemented by items relating to specific details of the scaffolding in question.
3. A copy of the plan, including any instructions it may contain, shall be made available for the use of the person supervising and the seafarers concerned in the assembly, use, dismantling or alteration of the scaffolding.
4. The bearing components of the scaffolding shall be prevented from slipping by:
 - attachment to the bearing surface;
 - provision of an anti-slip device; or
 - any other arrangement of equivalent effectiveness.
5. The load-bearing surface of the scaffolding shall be of sufficient capacity.
6. The scaffolding shall be positioned to ensure its stability.
7. Wheeled scaffolding shall be prevented by appropriate devices from moving accidentally during work at height.
8. The dimensions, form and layout of scaffolding decks shall:
 - be appropriate to the nature of the work to be performed;
 - be suitable for the loads to be carried; and
 - permit work and passage in safety.
9. Scaffolding decks shall be assembled in such a way that their components are prevented from moving inadvertently during work at height.
10. There shall be no dangerous gaps between the scaffolding deck components and the vertical collective safeguards to prevent falls.

11. When any part of a scaffold is not available for use, including during the assembly, dismantling or alteration of scaffolding, it shall be:
 - marked with general warning signs in accordance with the Merchant Shipping and Fishing Vessels (Safety Signs and Signals) Regulations 2001; and
 - suitably delineated by physical means preventing access to the danger zone.

12. Scaffolding shall be assembled, dismantled or significantly altered only under the supervision of a competent person and by seafarers who have received appropriate and specific training in the operations envisaged in accordance with regulation 12 of the Merchant Shipping and Fishing Vessels (Health and Safety at Work) Regulations 1997 No. 2962 and regulation 11 of the Merchant Shipping and Fishing Vessels (Provision and Use of Work Equipment) Regulations 2006 No. 2183, which shall include:
 - understanding the plan for the assembly, dismantling or alteration of the scaffolding;
 - safety during the assembly, dismantling or alteration of the scaffolding;
 - measures to prevent the risk of persons or objects falling;
 - safety measures in the event of changing weather conditions that could adversely affect the safety of the scaffolding;
 - permissible loads; and
 - any other risks that the assembly, dismantling or alteration of the scaffolding may entail.

13. For the purposes of this annex, 'competent person' means the person possessing the knowledge or experience necessary for the performance of the duties imposed on that person by this annex.

CHAPTER 18

PROVISION, CARE AND USE OF WORK EQUIPMENT

18.1 Suitability of work equipment

18.1.1 The term 'work equipment' applies to any machinery, appliance, apparatus, tool or installation provided for use at work. The exception to this is any safety equipment or apparatus provided in compliance with the International Convention for the Safety of Life at Sea (SOLAS) requirements, which is subject to other merchant shipping regulations.

18.1.2 Provision and use of work equipment on UK ships is governed by the Merchant Shipping and Fishing Vessels (Provision and Use of Work Equipment) Regulations 2006. The first part of this chapter lays down the basic safety standards applying to all work equipment. Sections 18.21 and onwards cover practical safety advice arising from the use of equipment on board ships. Some types of equipment that pose particular risks are covered by later sections. Lifting equipment, because of the serious hazards it presents, is dealt with in more detail in Chapter 19, Lifting plant and operations.

18.1.3 Work equipment provided on board is generally the responsibility of the Company. Where any work equipment is provided from ashore, responsibility for its condition will rest with the shore provider. However, the Company has responsibility to ensure that it is appropriately maintained while on board and used safely.

18.1.4 All work equipment should comply with any relevant standards laid down by merchant shipping or general UK regulations. Any equipment not covered by regulations or type approvals should comply with the appropriate British or European Standard or its nearest international equivalent. See Annex 18.1 for more details.

18.1.5 In addition, work equipment should be:

- suitable for the work to be carried out;
- properly adapted for that purpose; and
- capable of being used without any significant risks to the health and safety of any seafarer.

*S.I. 2006/2183
(as amended) and
MGN 331(M+F)*

Reg. 6(1)

18.1.6 Specific risks that should be considered include:

- mechanical risks such as crushing, impact, trapping or entanglement, cutting or friction; and
- non-mechanical risks such as noise, vibration, electrical hazards, temperature and radiation.

18.1.7 The regulations also draw attention to the following specified hazards:

- Any article or substance falling or being ejected from work equipment.
- Rupture or disintegration of parts of work equipment.
- Work equipment catching fire or overheating.
- The unintended or premature discharge of any article or any gas, dust, liquid, vapour or other substance that is produced, used or stored in the work equipment.
- The unintended explosion of the work equipment or any article or substance produced, used or stored in it.
- Work equipment being struck by lightning while being used.

18.1.8 Where any seafarer using work equipment is, or could be, exposed to one or more of the hazards listed, the Company should ensure that any significant risk to their health and safety is either prevented by the provision of appropriate work equipment or protective devices or, where that is not practicable, adequately controlled by appropriate means.

*S.I. 1999/2205
and MSN
1870(M+F)*

18.1.9 Tools should be used only for the purpose for which they were designed. Personnel should ensure that they use the correct tools or equipment for a task. Use of unsuitable tools or equipment may lead to accidents and incidents. Loose clothing or jewellery should never be worn while using machinery, because there is a risk that it may become caught in moving parts. For the same reason, long hair should always be tied back and covered with a hair net or safety cap. Personal protective equipment (PPE) should be provided and worn as required by the Merchant Shipping and Fishing Vessels (Personal Protective Equipment) Regulations 1999 and merchant shipping notice MSN 1870(M+F).

18.1.10 Only those competent to use equipment should do so. Seafarers new to the industry should always be trained in the proper use of any equipment before they are allowed to use it.

18.1.11 Incorrect use of tools and equipment can cause accidents and incidents, as well as damage to the equipment in question. Instructions

for use should always be consulted and followed when they are available.

18.1.12 When not in use, equipment should be stowed in a tidy and correct manner. Any cutting edges should be protected.

Regs 7 and 25

18.2 Maintenance

18.2.1 All work equipment is to be maintained in good repair and efficient working order in accordance with the manufacturer's instructions.

18.2.2 Maintenance should include regular inspections by a competent person. When there is any suspicion that any work equipment is not working properly, or has been subject to any treatment likely to cause damage, it should be taken out of service until it can be inspected and any necessary repairs or maintenance undertaken.

18.2.3 The decision on what maintenance work is required rests with the Company/competent person; however, the following should normally form part of a maintenance routine:

- Greasing of bearings, etc. should be thorough and frequent because bearings and other moving parts that are dry will impose additional loads that can lead to failure.
- The condition of all ropes and chains should be checked regularly for wear, damage or corrosion, and replaced as necessary.
- Regular function tests should be carried out on all controls, emergency stop controls, brakes, safety devices, etc. to ensure that they are operating correctly. Such checks should be carried out before the equipment is used.

18.2.4 Work equipment should, as far as possible, be constructed or adapted to permit maintenance operations to be carried out while the equipment is shut down. Where this is not possible, appropriate protective measures must be put in place to enable such maintenance operations to be carried out safely without exposing the person carrying out such maintenance, or any other person, to any significant risk to their health and safety. Such protective measures may include:

- keeping exposure of the dangerous part to the minimum necessary;
- authorisation of the exposure by a responsible ship's officer or other responsible person;
- permitting only a competent person to carry out the operation;

- ensuring that any person working close to the machinery has enough clear space and adequate light while they are working;
- ensuring that any person operating close to the machinery has adequate instruction in safe systems of work for that machinery, the dangers arising from its operation and the precautions to be taken; and
- the placing and display of a conspicuous warning notice on or close to the machinery.

18.2.5 Where any machinery has a maintenance log, the log should be kept up to date.

Reg. 8

18.3 Inspection

18.3.1 Where the safety of work equipment depends on the installation conditions, the equipment should be inspected by a competent person after the initial installation, or after re-assembly at a new site or in a new location, and before being put into service for the first time. This is to ensure that it has been installed correctly, in accordance with the manufacturer's instructions, and is safe to use. In this context, inspection means the carrying out of such visual or more rigorous inspection by a competent person and may include testing when it is considered appropriate.

18.3.2 Inspections should cover factors such as the standard of welding or other fixing and materials used, together with the strength of any part of the ship that supports it and to which it is attached. Account should also be taken of any inspection requirements or guidance produced by the manufacturer. Work equipment should be re-inspected at regular intervals, not exceeding five years or more frequently if recommended by the manufacturer, to ensure that no deterioration in its installation has occurred.

18.3.3 Structures should be examined frequently for corrosion, cracks, distortion or wear of bearings, securing points, etc. Hollow structures, such as gantries or masts, should also be checked for water trapped inside them. If water is found, the structure should be drained, suitably treated where practicable, and then sealed to prevent further ingress of water.

18.3.4 Any work equipment exposed to conditions causing deterioration should be inspected by a competent person at suitable intervals. On each occasion that exceptional circumstances have occurred that may jeopardise the safety of the work equipment, an additional inspection should take place to enable any necessary remedial action to be taken to ensure its continuing safety. In this context,

exceptional circumstances include modification work, accidents, exposure to weather and prolonged periods of inactivity.

18.3.5 The results of all inspections are to be recorded and all such records are to be retained, readily available for inspection, until such time as a further inspection has been undertaken and recorded.

18.3.6 Where any ship's work equipment is to be used outside the ship, or work equipment from outside the ship is obtained for use on the ship, it must be accompanied by physical evidence that the last inspection required to be carried out under the Merchant Shipping and Fishing Vessels (Provision and Use of Work Equipment) Regulations 2006 has actually been carried out. In this context, used outside the ship includes equipment used on the quayside, dock or jetty, the ship's boats, pontoons or on board another ship; it also applies to equipment operated by workers who are not employed by the Company.

18.3.7 Any work equipment used for lifting loads, including personnel, is also subject to the provisions of the Merchant Shipping and Fishing Vessels (Lifting Operations and Lifting Equipment) Regulations 2006, which set out specific requirements for the inspection, testing and thorough examination of such lifting equipment. This is dealt with in detail in Chapter 19, Lifting plant and operations, of this Code.

Reg. 9

18.4 Specific risks

18.4.1 Based on the findings of the risk assessment, appropriate control measures should be put in place to protect those who may be at risk whilst using work equipment.

18.4.2 Where a specific risk to health or safety is identified in relation to a particular item of work equipment, its use and any repairs, modifications or maintenance must only be carried out by seafarers who have been specifically designated to perform the particular task. These seafarers shall be competent, and shall have been provided with appropriate training either as a result of the seafarer's overall training for the position currently held, or provided by other qualified persons on board or ashore, including the manufacturer of the equipment.

Reg. 10

18.5 Information and instructions

18.5.1 All seafarers who use work equipment, and any managers or supervisors, should have access to all necessary health and safety information and written instructions relating to the use of that equipment. These should be in an easily understood form and should include information and, where appropriate, written instructions on the conditions in which the work equipment may be used and its

method of use. This should include foreseeable abnormal situations and the action to be taken if such a situation occurs; and information on any conclusions drawn from previous experience of using that work equipment.

18.5.2 Where any seafarer likely to use any item of work equipment does not understand the language in which such information and instructions are provided, appropriate measures should be taken to ensure that the information/instructions are provided in a language that the seafarer understands.

Reg. 11

18.6 Training

18.6.1 All seafarers who use work equipment, or who supervise its use, should have received adequate training covering the method of use of the equipment, any risks that may arise from its use and any precautions to be taken.

18.6.2 Similarly, seafarers specifically designated to carry out repairs, modifications, maintenance or servicing to work equipment, or who supervise such work, should have received adequate training for that purpose when the use of that equipment may involve a specific health and safety risk to the person using it, e.g. electrical equipment or mechanical cutting equipment.

18.6.3 In accordance with the International Safety Management (ISM) Code for Merchant Shipping, all such training is to be recorded and should indicate when full competence is achieved.

18.6.4 All instruction or information must be in the working language of the vessel.

Reg. 34

18.7 Duty of seafarers

18.7.1 All seafarers should comply fully with all instructions or training they have been given in respect of the use of any work equipment. No seafarer should operate any item of work equipment unless they are competent, and authorised, to do so.

Reg. 13

18.8 Dangerous parts of work equipment

18.8.1 Every dangerous or exposed working part of work equipment is to be provided with appropriate guards or protection devices. Such guards or protection devices are to be maintained and/or replaced as necessary and are to be kept in position when the relevant parts are in motion.

18.8.2 All guards or protection devices provided should:

- be of substantial construction;
- not give rise to any additional hazard;
- not be easily removed;
- be situated at a sufficient distance from the danger zone;
- not restrict the view of the operator of the equipment more than is necessary; and
- be so constructed or adapted that they allow operations necessary to fit or replace parts and for the carrying out of maintenance work, but restrict access only to the area where work is to be carried out and, where possible, without having to dismantle the guard or protection device.

18.8.3 The reference in section 18.8.2, bullet point four, to a danger zone means the zone within or around work equipment where the presence of a seafarer would expose them to a significant risk to their health or safety.

Reg. 14

18.9 Electrical equipment

18.9.1 All ship's electrical equipment and installations should be constructed, installed, operated and maintained in such a way that there is no electrical hazard to the ship or any person.

18.9.2 Isolation equipment and PPE appropriate to the ship's electrical installation should be carried, supplied and used as and when required.

Reg. 16

18.10 High or very low temperatures

18.10.1 Where any equipment, parts of equipment or anything produced by, used by, or stored in such equipment has the potential to burn, scald or cause any other injury to any seafarer by virtue of being at a high or low temperature, appropriate measures should be taken to prevent injury.

18.10.2 Appropriate measures may include guards or barriers to the hazardous parts of the equipment, isolation of the equipment or the provision of PPE.

Reg. 17

18.11 Controls for starting or making a significant change in operating conditions

18.11.1 Where any work equipment could constitute a risk to the health or safety of seafarers because it contains moving parts or is mobile,

it must be fitted with one or more controls for the purposes of starting it and controlling any change in its speed, pressure or other operating conditions. Additionally, it must only be possible to start the machine or change its speed, etc. by operation of the relevant control.

18.11.2 The requirements in the preceding paragraph do not apply to any automatic restarting or other changes in the operating conditions that occur as a result of the normal operating cycle of any work equipment.

Reg. 18

18.12 Stop controls

18.12.1 In addition to the requirements of section 18.11, where any work equipment could constitute a risk to health and safety, one or more readily accessible controls must be provided to either bring it to a stop or otherwise render it safe.

18.12.2 Any stop control must override any control required by section 18.11.

Reg. 19

18.13 Emergency stop controls

18.13.1 In addition to the requirements for stop controls under section 18.12, where any work equipment could constitute a risk to health and safety, one or more readily accessible emergency stop controls should be provided. An emergency stop control must override any controls required by sections 18.11 and 18.12.

Reg. 20

18.14 Controls

18.14.1 All operational controls for work equipment should be clearly visible and identifiable, including the provision of appropriate marking where necessary. No control should be placed in a position where any seafarer operating it is exposed to any significant risk to their health and safety.

18.14.2 Any seafarer operating the controls of any work equipment should be able to ensure from the control position that no other seafarer will be exposed to any significant risk to their health and safety as a result of the starting up or use of that equipment. Where such an arrangement is not reasonably practicable, appropriate systems of work must be introduced to ensure that no seafarer is exposed to any significant risk to their health and safety as a result of the starting up or use of the equipment. This may include audible, visible or other suitable warning devices, as required by sections 18.19 or 18.20 so that any seafarers likely to be affected are aware that the equipment is about to be started.

18.14.3 Any seafarers who are in the position where they would be exposed to a risk to their health and safety as a result of the starting or stopping of work equipment must be given sufficient time and suitable means to get out of the way prior to the starting or stopping of the equipment.

Reg. 21

18.15 Control systems

18.15.1 Any control systems for work equipment should be safe and take account of any risks to health and safety that might result from damage to or breakdown of that control system. In this context, a control system cannot be considered safe unless:

- its operation does not create any increased risk to health or safety;
- any fault in, or damage to, any part of the control system, or the loss of power supply to it, does not result in additional or increased risk to health or safety; and
- it does not impede the operation of any stop control required by sections 18.12 and 18.13 above.

Reg. 22

18.16 Isolation from sources of energy

18.16.1 Where the risk assessment indicates the need, work equipment should be provided with a suitable system for isolating it from all its sources of energy. Any isolating system should be clearly identified, capable of being locked off and indicated in the appropriate permit to work.

18.16.2 Suitable measures must also be in place to ensure that re-connection of any energy source to work equipment does not expose the seafarer using the equipment to any significant risk to their health and safety. Such measures must also be identified in the risk assessment and identified on the permit to work.

Reg. 23

18.17 Stability of work equipment

18.17.1 Where the safe use of any work equipment depends on its stability, it should be stabilised by use of clamps or another appropriate method.

18.17.2 In deciding the most appropriate method for stabilising work equipment, the potential movement of a ship under all conditions should be taken into account.

Reg. 24

18.18 Lighting

18.18.1 Adequate lighting, appropriate for the work to be undertaken, should be provided at any place where work equipment is used.

Reg. 26
MGN 556(M+F)

18.19 Markings

18.19.1 Where any health and/or safety markings are required to comply with the requirements of the Merchant Shipping and Fishing Vessels (Safety Signs and Signals) Regulations 2001, such markings that comply with MGN 556(M+F) and Chapter 9, Safety signs and their use, of this Code are to be provided and applied to the equipment in such a way that they are clearly visible to any person using or in the vicinity of that equipment.

Reg. 27

18.20 Warnings

18.20.1 Where any work equipment is required to be fitted with warning signs, warning devices, etc., their meaning should be clear and they should be easily seen or heard.

18.21 Hand tools

18.21.1 Damaged or worn tools should not be used, and cutting edges should be kept sharp and clean. Repair and dressing of tools should be carried out by a competent person.

18.21.2 Wherever practicable, a tool in use should be directed away from the body, so that if it slips it does not cause injury. However, when using a spanner more control is gained by pulling towards the body. When using a tool with a cutting edge, both hands should be kept behind the blade.

18.21.3 A chisel is best held between thumb and base of index finger with thumb and fingers straight, with palm of hand facing towards the hammer blow.

18.21.4 A saw should not be forced through the material being cut: it should be pushed with a light, even movement.

18.22 Portable power-operated tools and equipment

18.22.1 Power-operated equipment may be dangerous unless properly maintained, handled and used, and should only be operated by competent persons. The flexible cables of electric tools should comply with the relevant British or International Standard. Before work begins, personnel should ensure that power supply leads and hoses are in good

condition, laid safely clear of all potentially damaging obstructions and do not obstruct safe passage. Where they pass through doorways, the doors should be secured open.

18.22.2 The risk of electric shock is increased by perspiration and locations that are damp, humid or have large conductive surfaces. In such conditions, power tools should be operated from low voltage supplies, i.e. no more than 55 volts AC with a maximum of 30 volts to earth or 50 volts DC.

18.22.3 When it is not practicable to use low voltages, other precautions such as a local isolating transformer supplying one appliance only or a high-sensitivity earth leakage circuit breaker (also known as a residual current device) should be used.

18.22.4 The risk associated with portable electric tools also applies to portable electric lamps. The supply to these should not exceed 110 volts.

18.22.5 Double-insulated tools should not be used on ships outside the accommodation because water can provide a contact between live parts and the casing, increasing the risk of a fatal shock. An earth leakage circuit breaker may also fail to operate when used with such tools because there may be no earth wire in the power supply cable fitted to the tool.

18.22.6 Chain linkages or similar devices should be fitted between sections of pneumatic hose to prevent whiplash in the event of breakage. Alternatively, safety valves that close off the lines can be used.

18.22.7 Accessories and tool pieces (drill bits, chisel, etc.) should be absolutely secure in the tool. In particular, retaining springs, clamps, locking levers and other built-in safety devices on pneumatic tools should be replaced after the tool piece is changed. Accessories and tool pieces should not be changed while the tool is connected to a power source.

18.22.8 Correct safety guards should be securely fixed to appliances requiring them and should be checked for security before starting any operation. Such guards should only be removed when the equipment is not operating. If removal whilst operating is essential for maintenance or examination of the equipment, the following precautions should be taken:

- Removal should be authorised by a responsible person, and only a competent person should carry out the work or examination.
- There should be adequate clear space and lighting for the work to be done.

- Anyone working close to the machinery should be told what the risks are and instructed in a safe system of work and precautions to take.
- A warning notice should be conspicuously posted.

18.22.9 During temporary interruptions to work (e.g. meal breaks, and on completion of a task), equipment should be isolated from power sources and left safely or stowed away correctly.

18.22.10 When a work operation causes high noise levels, hearing protection should be worn. When flying particles may be produced, the face and eyes should be protected (see Chapter 8, Personal protective equipment).

18.22.11 The vibration caused by reciprocating tools (pneumatic drills, hammers, chisels, etc.) or high-speed rotating tools can give rise to a permanent disablement of the hands known as 'dead' or 'white' fingers. In its initial stages, this appears as a numbness of the fingers and an increasing sensitivity to cold but, in more advanced stages, the hands become blue and the fingertips swollen. Seafarers subject to the symptoms described should not use such equipment. Other seafarers should be advised not to use them for more than 30 minutes without a break, unless the risk assessment indicates a lesser period of use. Further information is given in Chapter 12, Noise, vibration and other physical agents.

18.23 Workshop and bench machines (fixed installations)

18.23.1 Fixed installations should only be operated by competent personnel. The operator should check a machine every time before use, and ensure that all safety guards and devices are in position and operative, that all tool pieces (drill bits, cutting blades, etc.) are in good condition, and that the work area is adequately lit and free from clutter.

18.23.2 No machine should be used when a guard or safety device is missing, incorrectly adjusted or defective, or when it is itself in any way faulty. If any defect is identified, the machine should be isolated from its power source until it has been repaired.

18.23.3 During operations, personnel should ensure that work pieces are correctly secured in position, and that machine residues (swarf, sandings, etc.) do not build up excessively and are disposed of in a correct and safe manner.

18.23.4 Whenever machinery is left unattended, even if only briefly, the power supply should be switched off and isolated, and the machinery and any safety guards should be re-checked before resuming work.

18.24 Abrasive wheels

18.24.1 Abrasive wheels should be selected, mounted and used only by competent persons and in accordance with manufacturers' instructions. They are relatively fragile and should be stored and handled with care.

18.24.2 Manufacturers' instructions should be followed on the selection of the correct type of wheel for the job in hand. Generally, soft wheels are more suitable for hard material and hard wheels for soft material.

18.24.3 Before a wheel is mounted, it should be brushed clean and closely inspected to ensure that it has not been damaged in storage or transit. The soundness of a vitrified wheel can be further checked by suspending it vertically and tapping it gently. If the wheel sounds dead, it is probably cracked and should not be used.

18.24.4 A wheel should not be mounted on a machine for which it is unsuitable. It should fit freely but not loosely to the spindle; if the fit is unduly tight, the wheel may crack as the heat of the operation causes the spindle to expand.

18.24.5 The clamping nut should be tightened only sufficiently to hold the wheel firmly. When the flanges are clamped by a series of screws, the screws should be first screwed home with the fingers and diametrically opposite pairs tightened in sequence.

18.24.6 The speed of the spindle should not exceed the stated maximum permissible speed of the wheel.

18.24.7 A strong guard, enclosing as much of the wheel as possible, should be provided and kept in position at every abrasive wheel, both to contain wheel parts in the event of a burst and to prevent an operator having contact with the wheel (see also section 18.22.8 above).

18.24.8 When a work rest is provided, it should be properly secured to the machine and adjusted as close as practicable to the wheel, the gap normally being not more than 1.5 mm (1/16 inch).

18.24.9 The side of a wheel should not be used for grinding: it is particularly dangerous when the wheel is appreciably worn.

18.24.10 The work piece should never be held in a cloth or pliers.

18.24.11 When dry grinding operations are being carried out and when an abrasive wheel is being trued or dressed, suitable transparent screens

should be fitted in front of the exposed part of the wheel and operators should wear properly fitting eye protectors. Eye protection should always be worn for grinding operations.

18.25 Hydraulic/pneumatic/high-pressure jetting equipment

18.25.1 Seafarers using hydraulic/pneumatic/high-pressure systems should have received adequate training and be competent to use such equipment. Manufacturers' operating guidelines should be followed at all times. Equipment should not be operated at pressures that exceed manufacturers' recommendations.

18.25.2 Before starting work, seafarers should ensure that the equipment and supply systems are in sound condition, and that incorporated safety devices are in place and functioning correctly. Where equipment is defective or suspect, systems should be shut down, isolated and depressurised to allow effective replacement or repair. Such repairs should only be carried out by authorised competent personnel using approved components.

18.25.3 Before activating a pressure system, and also when closing it down, the recommended checks should be made to ensure that no air pockets or trapped pressure are in the system, because these may cause erratic action of the equipment.

18.25.4 When handling hydraulic fluid, personnel should ensure that:

- the correct grade is used when topping up systems;
- spillages are cleaned up immediately;
- any splashes of such fluid onto skin areas are cleaned off immediately – many such fluids are mineral based;
- naked lights are kept away from equipment during service/ test periods – hydraulic fluids may give off vapours that may be flammable.

18.25.5 In the event of a high-pressure release of oil, air or any other substance that penetrates the skin, medical advice should be sought immediately.

18.25.6 Seafarers using high-pressure jetting equipment should wear the correct protective equipment. Such systems may involve use of a heated supply source and operators should therefore guard against splashing and scalding. Warning notices should be displayed on approaches to areas where such work is being undertaken to warn other seafarers of the use

of a high-pressure system in the area. Finally, seafarers should take great care in ensuring that the direction of such jetting is safe.

18.25.7 When compressed air is used, the pressure should be kept no higher than is necessary to undertake the work satisfactorily.

18.25.8 Compressed air should not be used to clean the working space and in no circumstances should it be directed at any part of a person's body.

18.26 Hydraulic jacks

18.26.1 Jacks should be inspected before use to ensure that they are in a sound condition and that the oil in the reservoir reaches the minimum recommended level.

18.26.2 Before a jack is operated, care should be taken to ensure that it has an adequate lifting capability for the work for which it is to be used, and that its foundation is level and of adequate strength.

18.26.3 Jacks should be applied only to the recommended or safe jacking points on equipment.

18.26.4 Equipment under which seafarers are required to work should be properly supported with chocks, wedges or by other safe means – never by jacks alone.

18.26.5 Jack operating handles should be removed if possible when not required to be in position for raising or lowering the jack.

Reg. 28

18.27 Carrying of seafarers on mobile work equipment

18.27.1 No seafarer is to be carried on any mobile work equipment unless it is designed for that purpose. In this context, designed for that purpose includes being fitted out in such a way as to minimise risks to the safety of any seafarer, including any risks from wheels or tracks. Such equipment must also incorporate measures to prevent it rolling over or, where that is not possible, reduce the risks to health or safety of seafarers should it roll over whilst being used. Such measures could include:

- stabilisation of the work equipment to prevent it rolling over;
- provision of a protection structure so that the work equipment cannot fall on its side;
- provision for a structure giving sufficient clearance around the seafarers being carried if the work equipment can overturn further than that; or

- any device that is equally effective in providing protection for the seafarers being carried.

18.27.2 Where there is a risk of any seafarer being carried by mobile work equipment being crushed in the event of it rolling over, it should be fitted with a restraining system for the person. This does not apply to a fork-lift truck with a structure as described in section 18.27.1, bullet points two and three.

Reg. 29

18.28 Overturning of fork-lift trucks

18.28.1 Any fork-lift truck to which section 18.27.2 applies and which carries a seafarer must be adapted or equipped to minimise the risk to health or safety from its overturning. In deciding what adaptations are required, account should be taken of the manner and conditions in which the fork-lift truck is being used.

18.28.2 Any seafarer operating a fork-lift truck must have received appropriate safety training including that relating to the individual type of fork-lift truck.

Reg. 30

18.29 Use of mobile work equipment

18.29.1 Where mobile work equipment is to be used on board a ship:

- no ship's powered vehicle or powered mobile lifting appliance shall be driven in the course of a work activity except by a competent person who is authorised to do so;
- where work equipment is moving around in a work area, appropriate traffic rules are drawn up and followed for the safety of seafarers and others;
- seafarers on foot should, so far as is reasonably practicable, be prevented from entering the area of operation of self-propelled work equipment;
- where work cannot be done properly unless seafarers on foot are present, appropriate measures are in place to prevent them from being injured by the work equipment.

18.29.2 Seafarers should be carried on mobile work equipment only when safe facilities are provided for this purpose. The speed of the work equipment should be adjusted as necessary for the safety of the seafarers.

18.29.3 Mobile work equipment fitted with a combustion engine should not be used in working areas unless sufficient ventilation can be guaranteed, so that the operation of the combustion engine presents no risk to the health or safety of seafarers.

Reg. 31

18.30 Self-propelled work equipment

18.30.1 When any self-propelled work equipment could present a hazard to health and safety while in motion:

- it should be fitted with a means (e.g. a key-operated switch) for preventing it from being started by an unauthorised person;
- where there is more than one item of rail-mounted work equipment in motion at the same time, it should be fitted with appropriate facilities for minimising the consequences of a collision;
- it should be fitted with braking and stopping devices;
- it should be fitted with emergency facilities operated by a readily accessible control or automatic system for braking and stopping if the main device fails;
- where the driver's direct field of vision is inadequate to ensure safety, there are adequate devices for improving their vision;
- if used in the dark:
 - it is to be fitted with lighting appropriate to the work to be carried out; and
 - it is sufficiently safe for such use;
- if it or anything carried or towed by it involves a risk from fire and is liable to injure seafarers, it should carry appropriate fire-fighting appliances, unless such appliances are kept sufficiently close to it.

Reg. 32

18.31 Remote-controlled self-propelled work equipment

18.31.1 Where any remote-controlled self-propelled equipment could endanger the safety of seafarers while it is in motion, it must be set up in such a way that it stops automatically once it leaves its control range. Additionally features to guard against the risk of crushing or other impact should be incorporated.

Reg. 33

18.32 Drive units and power take-off shafts

18.32.1 Where the seizure of a drive unit or power take-off could present a risk to seafarers, appropriate measures including the provision of guards or other protection devices referred to in section 18.8.1 should be taken.

18.33 Ropes

18.33.1 The safety of a ship or individual crew member is often dependent on the rope that is being used.

18.33.2 Many types of rope of both man-made and natural fibre are available, each with different properties and with different resistance to contamination by substances in use about the ship that may seriously weaken the rope. The following table is a guide to the resistance of the main rope types but is indicative only of the possible extent of deterioration of rope; in practice, much depends on the precise formulation of the material, the amount of contamination the rope receives and the length of time and the temperature at which it is exposed to contamination. In some cases, damage may not be apparent even on close visual inspection.

Substance	Resistance to chemicals of rope made of:					
	Manila or sisal	Polyamide (nylon)	Polyester	Polypropylene	Polyethylene (HMPE)	Aramid
Sulphuric (battery) acid	None	Poor	Good	Very good	Good	Poor
Hydrochloric acid	None	Poor	Good	Very good	Very good	Good
Typical rust remover	Poor	Fair	Good	Very good		
Caustic soda	None	Good	Fair	Very good	Very good	Good
Liquid bleach	None	Good	Very good	Very good	Very good	Good
Creosote, crude oil	Fair	None	Good	Very good		
Phenols, crude tar	Good	Fair	Good	Good	Very good	Good
Diesel oil	Good	Good	Good	Good		
Synthetic detergents	Poor	Good	Good	Good		
Chlorinated solvents, e.g. trichloroethylene (used in some paint and varnish removers)	Poor	Fair	Good	Poor	Very good	Good
Other organic solvents	Good	Good	Good	Good	Very good	Very good

18.33.3 Ropes should be stored away from heat, sunlight and extreme cold, if possible in a separate compartment that is dry and well ventilated, away from containers of chemicals, detergents, rust removers, paint strippers and other substances capable of damaging them. Mooring ropes should be covered by tarpaulins or, if the ship is on a long

voyage, stowed away. Any accidental contamination should be reported immediately for cleansing or other action.

18.33.4 Man-made fibre ropes have high durability and low water absorption and are resistant to rot. Mildew does not attack man-made fibre ropes but moulds can form on them. This will not normally affect their strength.

18.33.5 Polypropylene ropes, which have the best all-round resistance to attack from harmful substances, are generally preferred. However, they may be subject to degradation in strong sunlight ('actinic degradation'), and should not be exposed for long periods. They should also be of a type providing grip comparable to that of manila or sisal ropes.

18.33.6 New rope, three-strand fibre rope and wire should be taken out of a coil in such a fashion as to avoid disturbing the lay of the rope.

18.33.7 Ropes should be inspected internally and externally before use for signs of deterioration, undue wear or damage.

18.33.8 When using steel wire ropes, it is important that they are properly installed, maintained and lubricated as appropriate to their use. Manufacturers' guidelines and recommendations for use should be followed. When eyes are formed, they should be made by eye-splicing or using appropriate compression fittings (using swages or ferrules). The use of bulldog grips is discouraged, and they must not be used on lifting wires or mooring wires. Annex 18.2 gives further information regarding bulldog grips.

18.34 Characteristics of man-made fibre ropes

18.34.1 Safe handling of man-made fibre ropes requires techniques that differ from those for handling natural fibre ropes.

18.34.2 Man-made fibre ropes are relatively stronger than those of natural fibre and so for any given breaking strain have appreciably smaller circumferences; however, wear or damage will diminish strength to a greater extent than the same amount of wear or damage would on a natural fibre rope. Recommendations for substitution of natural fibre ropes by man-made fibre ropes are given in the table on the following page.

18.34.3 Careful inspection of man-made fibre ropes for wear externally and internally is necessary. A high degree of powdering between strands indicates excessive wear and reduced strength. Ropes with high stretch suffer greater inter-strand wear than others. Hardness and stiffness in some ropes, polyamide (nylon) in particular, may also indicate overworking.

Manila		Polyamide (nylon, etc.)		Polyester (terylene)		Polypropylene	
Diameter (mm)	Size	Diameter (mm)	Size	Diameter (mm)	Size	Diameter (mm)	Size
48	6	48	6	48	6	48	6
56	7	48	6	48	6	52	6.5
64	8	52	6.5	52	6.5	56	7
72	9	60	7.5	60	7.5	64	8
80	10	64	8	64	8	72	9
88	11	72	9	72	9	80	10
96	12	80	10	80	10	88	11
112	14	88	11	88	11	96	12

Diameter given for three-strand, size number for eight-strand plaited.

18.34.4 Unlike natural fibre ropes, man-made fibre ropes give little or no audible warning of approaching breaking point.

18.34.5 Rope of man-made material stretches under load to an extent that varies according to the material. Polyamide rope stretches the most. Stretch imparted to man-made fibre rope, which may be up to double that of natural fibre rope, is usually recovered almost instantaneously when tension is released. A break in the rope may therefore result in a dangerous backlash and an item of running gear breaking loose may be projected with lethal force. Snatching of such ropes should be avoided; when it may occur inadvertently, personnel should stand well clear of the danger areas. The possibility of a mooring or towing rope parting under the load is reduced by proper care, inspection and maintenance and by its proper use in service, but it can nevertheless still happen without warning.

18.34.6 Man-made fibre ropes may easily be damaged by melting if frictional heat is generated during use. Too much friction on a warping drum may fuse the rope with consequential sticking and jumping of turns, which can be dangerous. Polypropylene is more liable to soften than other material. To avoid fusing, ropes should not be surged unnecessarily on winch barrels. For this reason, a minimum of turns should be used on the winch barrel; three turns are usually enough but, on whelped drums, one or two extra turns may be needed to ensure a good grip; these should be removed as soon as practicable.

18.34.7 The method of making eye splices in ropes of man-made fibres should be chosen according to the material of the rope.

- Polyamide (nylon) and polyester fibre ropes need four full tucks in the splice each with the completed strands of the rope, followed by two tapered tucks for which the strands are halved and quartered for one tuck each respectively. The length of the splicing tail from the finished splice should be equal to at least three rope diameters. The portions of the splice containing the tucks with the reduced number of filaments should be securely wrapped with adhesive tape or other suitable material.
- Polypropylene ropes should have at least three but not more than four full tucks in the splice. The protruding spliced tails should be equal to three rope diameters at least.
- Polythene ropes should have four full tucks in the splice with protruding tails of three rope diameters at least.

18.34.8 Mechanical fastenings should not be used in lieu of splices on man-made fibre ropes because strands may be damaged during application of the mechanical fastening, and the grip of the fastenings may be much affected by slight, unavoidable fluctuations in the diameter of the strands.

18.34.9 Man-made fibre stoppers of like material (but not polyamide) should be used on man-made fibre mooring lines, preferably using the 'West Country' method (double and reverse stoppering).

18.35 Laundry equipment

MSN 1838(M)

18.35.1 All seafarers required to work in a laundry, or use any part of the equipment there, must be fully instructed on the proper operation of the machinery. When a seafarer is under 18 years of age, they should not work on industrial washing machines, hydro-extractors, calender presses or garment presses unless they have been fully trained in the operation of the machine and the precautions to be observed and, if appropriate, are closely supervised by a competent person.

18.35.2 Equipment should be inspected before use for faults and damage. Particular attention should be paid to the automatic cut-off or interlocking arrangements on washing machines, hydro-extractors, etc., and the guards and emergency stops on presses, calender presses, mangling and wringing machines. Any defect or irregularity found during inspection, or apparent during operation of the equipment, should be reported immediately and the use of the machine discontinued until such time as any necessary repairs or adjustments have been carried out. A notice warning against use should be displayed prominently on the defective machine.

18.35.3 Frequent and regular inspection, with thorough checking of all electrical equipment and apparatus, is also necessary to ensure the standard of maintenance essential for laundries.

18.35.4 Machines should not be overloaded and loads should be distributed uniformly.

18.35.5 Reliance should not be placed entirely on interlocking or cut-off arrangements on the doors of washing machines, hydro-extractors and drying tumblers, etc.; doors should not be opened until all movement has ceased.

Annex 18.1 Conformity with community requirements

All work equipment should conform to the appropriate European product standards, apart from equipment that pre-dates any relevant standards. This annex details the UK instruments that give effect to the relevant EC/EU directives. Work equipment that carries a **CE** marking is considered to comply with the provisions of a community directive, provided that the **CE** marking is relevant for the purpose for which the equipment is to be used. In this context, 'CE marking' means a marking signifying compliance with basic requirements of design, manufacture of, and the specifications and test methods applicable to, a piece of work equipment, which have been adopted by the appropriate authorities in the European Economic Area. Reference to a **CE** marking also includes the marking for an alternative standard that provides equivalent levels of safety, suitability and fitness for purpose.

Instruments that give effect to community directives concerning the safety of products

Title	Reference
The Low Voltage Electrical Equipment (Safety) Regulations 1989	S.I. 1989/728, amended by S.I. 1994/3260
The Simple Pressure Vessels (Safety) Regulations 1991	S.I. 1991/2749, amended by S.I. 1994/3098
The Personal Protective Equipment (EC Directive) Regulations 1992	S.I. 1992/3139, amended by S.I. 1993/3074, S.I. 1994/2326 and S.I. 1996/3039
The Electrical Equipment (Safety) Regulations 1994	S.I. 1994/3260
The Equipment and Protective Systems Intended for Use in Potentially Explosive Atmospheres Regulations 1996	S.I. 1996/192, amended by S.I. 1998/81, S.I. 2001/3766 and S.I. 2005/830
The Lifts Regulations 1997	S.I. 1997/831, amended by S.I. 2004/693 and S.I. 2005/831
The Merchant Shipping (Marine Equipment) Regulations 1999	S.I. 1999/1957, amended by S.I. 2001/1638, S.I. 2004/302, S.I. 2004/1266 and S.I. 2009/2021
The Pressure Equipment Regulations 1999	S.I. 1999/2001, amended by S.I. 2002/1267, S.I. 2004/693 and S.I. 2015/399
The Merchant Shipping and Fishing Vessels(Personal Protective Equipment) Regulations 1999	S.I. 1999/2205
The Radio Equipment and Telecommunications Terminal Equipment Regulations 2000	S.I. 2000/730, amended by S.I. 2003/1903, S.I. 2003/3144 and S.I. 2005/281

Title	Reference
The Noise Emission in the Environment by Equipment for Use Outdoors Regulations 2001	S.I. 2001/1701, amended by S.I. 2001/3958 and S.I. 2005/3525
The Medical Devices Regulations 2002	S.I. 2002/618, amended by S.I. 2003/1400, S.I. 2003/1697, S.I. 2005/2759, S.I. 2005/2909, S.I. 2007/400, S.I. 2008/2936 and S.I. 2013/2327
The Electromagnetic Compatibility Regulations 2005	S.I. 2005/281, amended by S.I. 2006/1258 and S.I. 2006/1449
The Supply of Machinery (Safety) Regulations 2008	S.I. 2008/1597
The Construction Products Regulations 2013	S.I. 2013/1387

Annex 18.2 Bulldog grips

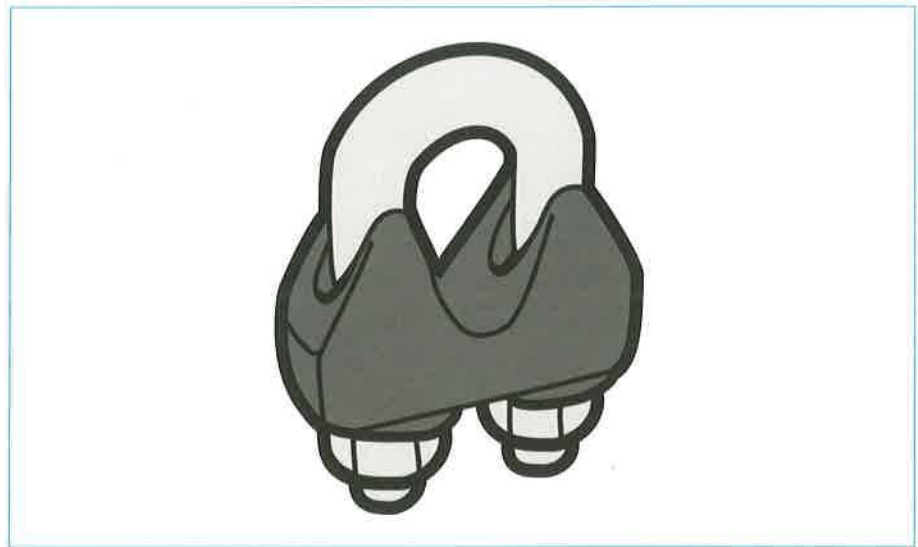

- The use of bulldog grips is discouraged, and they must not be used on lifting wires or mooring wires.
- Do not use where the rope is likely to be subjected to very strong vibrations.
- Do not use with plastic-coated wire rope.
- It is important that where bulldog grips are used, they are installed correctly as per the manufacturer's instructions.
- The 'U' of the grip must be placed on the dead end of the rope as illustrated, with the distance between grips being approximately six rope diameters. The minimum number of grips is dependent on the rope diameter; after being in service for several hours, the grips should be re-tightened, and re-checked for tightness periodically. Correctly fitted grips would be expected to hold at least 80% of the minimum breaking load of the rope.

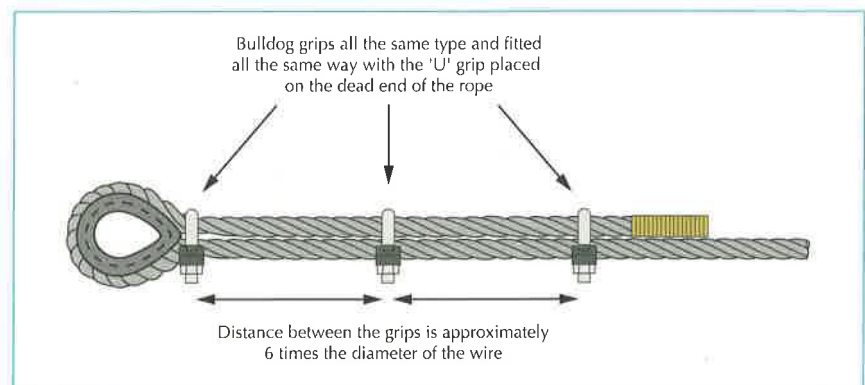

Blank page

CHAPTER 19

LIFTING PLANT AND OPERATIONS

19.1 Introduction

*S.I. 2006/2184
and MGN
332(M+F)*

19.1.1 The Merchant Shipping and Fishing Vessels (Lifting Operations and Lifting Equipment) Regulations 2006 introduce measures intended to protect workers from risks arising from the provision and use of lifting equipment. Full guidance is given in marine guidance note MGN 332(M+F).

MGN 331(M+F)

19.1.2 The general principles on provision, care and use of work equipment, set out in Chapter 20, Work on machinery and power systems, are also applicable to lifting plant, following the provisions of the Merchant Shipping and Fishing Vessels (Provision and Use of Work Equipment) Regulations 2006. Full guidance on those regulations is given in MGN 331(M+F). Where there is any overlap, the more stringent regulations apply.

19.2 General requirements

Lifting equipment

Reg. 6

19.2.1 Lifting equipment is required to be:

- of adequate strength and stability for each load, having regard in particular to the stress induced at its mounting or fixing points; and
- securely anchored; or
- adequately ballasted or counterbalanced; or
- supported by outriggers, as necessary to ensure its stability when lifting.

19.2.2 A valid certificate of testing and thorough examination by a competent person should be in force for every item of lifting equipment, accessory for lifting and loose gear. All items should be tested, and then thoroughly examined and certificated for use,

- after manufacture or installation; or
- after any repair or modification that is likely to alter the safe working load (SWL) or affect the strength or stability of the equipment.

A certificate for a ship's lifting equipment is valid for no more than five years.

The format for such certificates is shown in Annex 19.1.

Lifting equipment should be of steel or other acceptable material and securely fastened to the vessel's structure. The maximum SWL and maximum radius of operation of all derricks and lifting appliances are required to be part of the specification on all new constructions with associated ropes, wires and guys, eye-plates, shackles and blocks designed to meet these loads.

19.2.3 The vessel's structure, crane, davit, derrick or other lifting device and the supporting structure should be of sufficient strength to withstand the loads that will be imposed when operating at its maximum load moment.

19.2.4 In addition to the strength and stability of the lifting equipment, consideration should also be given to the stability, angle of heel and potential down-flooding of any vessel as a result of the use of a crane, davit, derrick or other lifting device fitted on it. This is especially important where a crane is to be fitted on a work boat or other small vessel, and it is recommended that advice should be sought from the crane manufacturer in such cases prior to the crane being fitted. Similarly, it is recommended that a check of the vessel's stability should be carried out by a suitably qualified person prior to installation of a crane, to ensure that the vessel is capable of operating safely with the crane fitted and in use. Failure to do this could have serious consequences for the safety of the vessel and the workers on it.

19.2.5 Any welding of material should be to an approved, acceptable standard because any fitting is only as strong as the weld that connects it to the vessel's structure.

19.2.6 If counterbalance weights are moveable, effective precautions should be taken to ensure that the lifting appliance is not used for lifting in an unstable condition. In particular, all weights should be correctly installed and positioned.

19.2.7 Lifting equipment with pneumatic tyres should not be used unless the tyres are in a safe condition and inflated to the correct pressures. Means to check this should be provided.

19.2.8 The operator should check safety devices fitted to lifting appliances before work starts and at regular intervals thereafter to ensure that they are working properly.

Accessories for lifting

19.2.9 Every part of a load that is used in lifting it, as well as anything attached to the load and used for that purpose, should be of good construction, of adequate strength for the purpose for which it is to be used and free from defects.

19.2.10 When selecting accessories for lifting, the following should be taken into account:

- The loads to be handled.
- The gripping points.
- The loose gear for attaching the load, and for attaching the accessories to the lifting equipment.
- The atmospheric and environmental conditions.
- The mode and configuration of slinging.
- Vessel motions.
- Stability issues.

19.2.11 Accessories for lifting should be stored in conditions that will not result in damage or degradation.

19.3 Register of lifting appliances

19.3.1 All vessels are required to maintain records of manufacture, examination, inspection and testing of lifting equipment. A form for the register of lifting appliances and loose gear, based on the model recommended by the International Labour Organization, is given in Annex 19.2, Register of ship's lifting appliances and cargo-handling gear.

19.4 Regular maintenance

19.4.1 In order to ensure that all parts of lifting equipment and related equipment are kept in good repair and working order, regular preventative maintenance should be carried out. Maintenance should include regular examinations by a competent person. Such examinations should be carried out as required by the Regulations but in any event at least once annually. Checks should look for general material defects such as cracks, distortion, corrosion and wear and tear that could affect SWL and overall strength.

19.4.2 When there is any suspicion that any lifting appliance or item of equipment may have been subjected to excessive loads, exceeding the SWL, or subjected to treatment likely to cause damage, it should be taken out of service until it can be subjected to a thorough examination by a competent person.

19.4.3 Listed below are some suggested maintenance items:

- Greasing should be thorough and frequent, because dry bearings impose additional loads that can lead to failure.

- The condition of all ropes, wires and chains should be checked regularly for wear, damage and corrosion and replaced as necessary. Particular care should be taken to examining ropes thoroughly including lengths that remain static in use, which may also be located in areas difficult to access.
- Shackles, links and rings should be renewed when wear or damage is evident.
- Structures should be examined frequently for corrosion, cracks, distortion and wear of bearings, securing points, etc.
- Hollow structures such as gantries or masts should be checked for water trapped inside. If water is found, the structure should be drained, appropriately treated and then sealed.
- Regular function tests of controls, stops, brakes, safety devices for hoisting gear, etc. should be carried out preferably before the start of operations.

This list is illustrative only and additional items may be appropriate dependent upon the equipment fitted to an individual vessel.

19.4.4 Any replacement parts must be in accordance with the manufacturer's instructions and of an equivalent construction to the original part. This is because replacement with incorrect parts or counterfeit parts of inferior quality can seriously affect the safety of a lifting appliance.

19.4.5 After any repairs or alterations are made to any lifting appliance, it should undergo a thorough examination and be retested if appropriate. This also applies if any significant changes are made or noticed to the general condition of the appliance.

19.5 Thorough examination and inspection

19.5.1 Where the safety of lifting equipment depends on the installation conditions, it should be inspected by a competent person before it is used for the first time. Such inspections should be undertaken on initial installation or after re-assembly at another location, to ensure that it has been installed correctly, in accordance with any manufacturer's instructions, and is safe for workers to operate as well as being able to function safely.

19.5.2 Any lifting equipment or accessory for lifting that is, or has been, exposed to conditions that could cause deterioration in its condition should be:

- thoroughly examined;

- in the case of lifting equipment for lifting persons or an accessory for lifting, at least every six months;
 - in the case of other lifting equipment, at least every 12 months; or
 - in either case, in accordance with an examination scheme; and
 - whenever exceptional circumstances that are liable to jeopardise the safety of the lifting equipment have occurred; and
- where appropriate, inspected by a competent person at suitable intervals.

19.5.3 No accessories for lifting, other than those that are subject to section 19.5.2, first bullet point, should be used unless they have been thoroughly examined within the 12 months immediately prior to such use.

19.6 Certificates

19.6.1 The Company is required to ensure that a certificate is obtained no later than 28 days after the carrying out of any test and thorough examination of any lifting equipment. Work should not proceed in the absence of a valid certificate.

19.7 Reports, records and marking of lifting equipment

*Reg. 9
MGN 332(M+F)*

19.7.1 Full details of the inspection requirements for reporting on the examination of any lifting equipment, reporting of defects and marking of equipment are contained within MGN 332(M+F).

19.8 Controls

19.8.1 Controls of lifting appliances should be permanently and legibly marked with their function and their operating directions shown by arrows or other simple means, indicating the position or direction of movement for hoisting or lowering, slewing or luffing, etc.

19.8.2 Makeshift extensions should not be fitted to controls nor any unauthorised alterations made to them. Foot-operated controls should have slip-resistant surfaces.

19.8.3 No lifting device should be used with any locking pawl, safety attachment or device rendered inoperative. If, exceptionally, limit switches need to be isolated in order to lower a crane to its stowage position, the utmost care should be taken to ensure the operation is completed safely.

19.9 Safety measures

Reg. 10

19.9.1 A powered appliance should always have a person at the controls while it is in operation; it should never be left to run with a control secured in the 'ON' position.

19.9.2 If any powered appliance is to be left unattended with the power on, loads should be taken off and controls put in a 'NEUTRAL' or 'OFF' position. Where practical, controls should be locked or otherwise inactivated to prevent accidental restarting. When work is completed, the power should be shut off.

19.9.3 The person operating any lifting appliance should have no other duties that might interfere with their primary task. They should be in a proper and protected position, facing the controls and, so far as is practicable, with a clear view of the whole operation.

19.9.4 Where the operator of the lifting appliance does not have a clear view of the whole of the path of travel of any load carried by that appliance, appropriate precautions should be taken to prevent danger. Generally this requirement should be met by the employment of a competent and properly trained signaller designated to give instructions to the operator. A signaller includes any person who gives directional instructions to an operator while they are moving a load, whether by manual signals, by radio or otherwise.

19.9.5 The signaller should have a clear view of the path of travel of the load where the operator of the lifting appliance cannot see it.

19.9.6 Where necessary, additional signallers should be employed to give instructions to the first signaller.

19.9.7 Every signaller should be in a position that is:

- safe; and
- in plain view of the person to whom they are signalling unless an effective system of radio or other contact is in use.

19.9.8 All signallers should be instructed in and should follow a clear code of signals, agreed in advance and understood by all concerned in the operation. Examples of hand signals recommended for use with lifting appliances on ships are shown in Annex 19.3, Code of hand signals.

19.9.9 If a load can be guided by fixed guides, or by electronic means, or in some other way, so that it is as safely moved as if it was being controlled by a competent team of driver and signallers, signallers will not be necessary.

19.10 Positioning and installation

19.10.1 Permanently installed lifting equipment should not be used unless it has been positioned or installed in such a way as to minimise the risk of:

- the equipment or a load striking a worker;
- a load drifting dangerously or falling freely; or
- a load being released unintentionally.

19.11 Lifting operations

19.11.1 Every lifting operation must be:

- subject to risk assessment;
- properly planned;
- appropriately supervised; and
- carried out in a safe manner.

19.11.2 No lifting operation should begin using equipment that is mobile or can be dismantled unless the Company is satisfied that the lifting equipment will remain stable during use under all foreseeable conditions, taking into account the nature of the surface on which it stands.

19.11.3 All lifting operations must be properly planned, appropriately supervised and carried out to protect the safety of workers. Whilst this applies to all vessels, it is particularly important when cranes are being used on work boats and other small vessels, because overloading of a crane, or attempting to lift at the wrong angle could, in some circumstances, result in the vessel sinking.

19.11.4 No person should be lifted except where the equipment is designed or specially adapted and equipped for that purpose, or for rescue or in emergencies.

19.11.5 Contact with bare ropes or warps with moving parts of the equipment should be minimised by the installation of appropriate protective devices.

19.11.6 Weather conditions can play a significant part in lifting operations. High winds or wave action may cause suspended loads to swing dangerously or mobile equipment to topple. Consideration should be given to the effects of weather conditions on all lifting operations, whether inside the ship or outside on deck, and such operations should be suspended before conditions deteriorate to the extent that lifting becomes dangerous.

19.11.7 Under no circumstances should personnel stand on, stand below or pass beneath a load that is being lifted. Loads should not be lifted over any access way.

19.11.8 All loads should be properly slung and properly attached to lifting gear, and all gear properly attached to appliances.

19.11.9 The use of lifting appliances to drag heavy loads with the fall at an angle to the vertical is inadvisable because of the friction and other factors involved, and should only take place in exceptional circumstances where the angle is small, there is ample margin between the loads handled and the SWL of the appliance, and particular care is taken. In all other cases, winches should be used instead. Derricks should never be used in union purchase for such work.

19.11.10 Any lifts by two or more appliances simultaneously can create hazardous situations and should only be carried out when unavoidable. They should be properly conducted under the close supervision of a responsible person, after thorough planning of the operation.

19.11.11 Lifting appliances should not be used in a manner likely to subject them to excessive overturning moments.

19.11.12 Ropes, chains and slings should not be knotted.

19.11.13 A thimble or loop splice in any wire rope should have at least three tucks, with a whole strand of rope and two tucks, with one half of the wires cut out of each strand. The strands in all cases should be tucked against the lay of the rope. Any other form of splice that can be shown as equivalent can also be used.

19.11.14 Lifting gear should not be passed around edges liable to cause damage, without appropriate packing.

19.11.15 Where a particular type of load is normally lifted by special gear, such as plate clamps, other arrangements should only be substituted if they are equally safe.

19.11.16 The manner of use of natural and man-made fibre ropes, magnetic and vacuum lifting devices and other gear should take proper account of the particular limitations of the gear and the nature of the load to be lifted.

19.11.17 Wire ropes should be regularly inspected and treated with suitable lubricants. These should be thoroughly applied so as to prevent internal corrosion as well as corrosion on the outside. The ropes should never be allowed to dry out.

19.11.18 Cargo-handling equipment that is lifted onto or off ships by crane or derrick should be provided with suitable points for the

attachment of lifting gear, so designed as to be safe in use. The equipment should also be marked with its own gross weight and SWL.

19.11.19 Before any attempt is made to free equipment that has become jammed under load, every effort should first be made to take the load off safely. Precautions should be taken to guard against sudden or unexpected freeing. Others not directly engaged in the operation should keep in safe or protected positions.

19.11.20 When machinery and, in particular, pistons are to be lifted by means of screw-in eye-bolts, the eye-bolts should be checked to ensure that they have collars, that the threads are in good condition and that the bolts are screwed hard down on to their collars. Screw holes for lifting bolts in piston heads should be cleaned and the threads checked to see that they are not wasted before the bolts are inserted.

19.12 Safe working load

19.12.1 A load greater than the SWL should not be lifted unless:

- a test is required by regulation; and
- the weight of the load is known and is the appropriate proof load; and
- the lift is a straight lift by a single appliance; and
- the lift is supervised by a competent person who would normally supervise a test and carry out a thorough inspection; and
- the competent person specifies in writing that the lift is appropriate in weight and other respects to act as a test of the plant, and agrees to the detailed plan of the lift; and
- no person is exposed to danger thereby.

19.12.2 Any grab fitted to a lifting appliance should be of an appropriate size, taking into account the SWL of the appliance, the additional stresses on the appliance likely to result from the operation and the material being lifted.

19.12.3 In the case of a single sheave block used in double purchase, the working load applied to the wire should be assumed to equal half the load suspended from the block.

19.12.4 The SWL of a lift truck means its actual lifting capacity, which in the case of a fork-lift truck, relates the load that can be lifted to, the distance from the centre of gravity of the load from the heels of the forks. It may also specify lower capacities in certain situations, e.g. for lifts beyond a certain height.

19.13 Use of winches and cranes

19.13.1 The drum end of wire runners or falls should be secured to winch barrels or crane drums by proper clamps or U-bolts. The runner or fall should be long enough to leave at least three turns on the barrel or drum at maximum normal extension. Slack turns of wire or rope on a barrel or drum should be avoided because they are likely to pull out suddenly under load.

19.13.2 When a winch is changed from single to double gear or vice versa, any load should first be released and the clutch secured so that it cannot become disengaged when the winch is working.

19.13.3 Steam winches should be so maintained that the operator is not exposed to the risk of scalding by leaks of hot water and steam.

19.13.4 Before a steam winch is operated, the cylinders and steam pipes should be cleared of water by opening the appropriate drain cocks. The stop valve between winch and deck steam line should be kept unobstructed. Adequate measures should be taken to prevent steam obscuring the driver's vision in any part of a working area.

19.13.5 Ships' cranes should be properly operated and maintained in accordance with the manufacturers' instructions. The Company and the master, as appropriate, should ensure that sufficient technical information is available, including the following:

- Length, size and SWL of falls and topping lifts.
- SWL of all fittings.
- Boom lifting angles.
- Manufacturers' instructions for replacing wires, topping up hydraulics and other maintenance as appropriate.

19.13.6 Power-operated rail-mounted cranes should have the following facilities incorporated in their control systems:

- Facilities to prevent unauthorised start-up.
- An efficient braking mechanism that will arrest the motion along the rails and, where safety constraints require, emergency facilities operated by readily accessible controls or automatic systems for braking or stopping equipment in the event of failure of the main facility.
- Guards that reduce as far as possible the risk of the wheels running over people's feet, and which will remove loose materials from the rails.

19.13.7 When a travelling crane is moved, any necessary holding bolts or clamps should be replaced before operations are resumed.

19.13.8 Access to a crane should always be by the proper means provided. Cranes should be stationary while accessing.

19.14 Use of derricks

19.14.1 Ships' derricks should be properly rigged and the Company and the master should ensure that rigging plans are available that include information on the:

- position and size of deck eye-plates;
- position of inboard and outboard booms;
- maximum headroom, i.e. permissible height of cargo hook above hatch coaming;
- maximum angle between runners;
- position, size, and SWL of blocks;
- length, size and SWL of runners, topping lifts, guys and preventers;
- SWL of shackles;
- position of derricks producing maximum forces;
- optimum position for guy and preventers to resist maximum forces;
- combined load diagrams showing forces for a load of 1 tonne or the SWL; and
- guidance on the maintenance of the derrick rig.

19.14.2 The operational guidance in the remainder of this section applies generally to the conventional type of ship's derrick. For other types, such as the 'Hallen' and 'Stulken' derricks, manufacturers' instructions should be followed.

19.14.3 Runner guides should be fitted to all derricks so that when the runner is slack, the bight is not a hazard to persons walking along the decks. Where rollers are fitted to runner guides, they should rotate freely.

19.14.4 Before a derrick is raised or lowered, all persons on deck in the vicinity should be warned so that no person stands in, or is in danger from, bights of wire and other ropes. All necessary wires should be flaked out.

19.14.5 When a single span derrick is being raised, lowered or adjusted, the hauling part of the topping lift or bull wire (i.e. winch-end whip) should be adequately secured to the drum end.

19.14.6 The winch driver should raise or lower the derrick at a speed consistent with the safe handling of the guys.

19.14.7 Before a derrick is raised, lowered or adjusted with a topping lift purchase, the hauling part of the span should be flaked out for its entire length in a safe manner. Someone should be available to assist the person controlling the wire on the drum and keeping the wire clear of turns and in making fast to the bitts or cleats. Where the hauling part of a topping lift purchase is led to a derrick span winch, the bull wire should be handled in the same way.

19.14.8 To fasten the derrick in its final position, the topping lift purchase should be secured to bitts or cleats by first putting on three complete turns followed by four crossing turns and finally securing the whole with a lashing to prevent the turns jumping off due to the wire's natural springiness.

19.14.9 When a derrick is lowered on a topping lift purchase, someone should be detailed for lifting and holding the pawl bar, ready to release it should the need arise; the pawl should be fully engaged before the topping lift purchase or bull wire is released. The person employed on this duty should not attempt or be given any other task until this operation is complete; in no circumstances should the pawl bar be wedged or lashed up.

19.14.10 A derrick with a topping winch, and particularly one that is self-powered, should not be topped hard against the mast, table or clamp in such a way that the initial heave required to free the pawl bar prior to lowering the derrick cannot be achieved without putting an undue strain on the topping lift purchase and its attachments.

19.14.11 A heel block should be secured additionally by means of a chain or wire so that the block will be pulled into position under load but does not drop when the load is released.

19.14.12 The derrick should be lowered to the deck or crutch and properly secured whenever repairs or changes to the rig are to be carried out.

19.14.13 If heavy cargo is to be dragged under deck with a ship's winches, the runner should be led directly from the heel block to avoid overloading the derrick boom and rigging. Where a heavy load is to be removed, a snatch block or bull wire should be used to provide a fair-lead for the runner and to keep the load clear of obstructions.

19.15 Use of derricks in union purchase

19.15.1 When using union purchase, the following precautions should be strictly taken to avoid excessive tensions:

- The angle between the married runners should not normally exceed 90° and an angle of 120° should never be exceeded.
- The cargo sling should be kept as short as possible so as to clear the bulwarks without the angle between the runners exceeding 90° (or 120° in special circumstances).
- The derricks should be topped as high as practicable, consistent with safe working.
- The derricks should not be rigged further apart than is absolutely necessary.

19.15.2 The following examples will show how rapidly loads increase on derricks, runners and attachments as the angle between runners increases:

- At a 60° included angle, the tension in each runner would be just over half the load.
- At 90° , the tension would be nearly three-quarters of the load.
- At 195° , the tension would be nearly 12 times the load.

19.15.3 When using union purchase, winch operators should wind in and pay out in step; otherwise, dangerous tensions may develop in the rig.

19.15.4 An adequate preventer guy should always be rigged on the outboard side of each derrick when used in union purchase. The preventer guy should be looped over the head of the derrick, and as close to and parallel with the outboard guy as available fittings permit. Each guy should be secured to individual and adequate deck or other fastenings.

19.15.5 Narrow angles between derricks and outboard guys and between outboard guys and the vertical should be avoided in union purchase because these materially increase the loading on the guys. The angle between the outboard derrick and its outboard guy and preventer should not be too large and may cause the outboard derrick to jack-knife. In general, the inboard derrick guys and preventer should be secured as nearly as possible at an angle of 90° to the derrick.

19.16 Use of stoppers

19.16.1 Where fitted, mechanical topping lift stoppers should be used. Where chain stoppers are used, they should **always** be applied by two half-hitches in the form of a cow hitch, suitably spaced with the remaining chain and rope tail backed round the wire and held taut to the wire.

19.16.2 A chain stopper should be shackled as near as possible in line with the span downhaul and always to an eye-plate, not passed round on a bight, which would induce bending stresses similar to those in a knotted chain.

19.16.3 No stopper should be shackled to the same eye-plate as the lead block for the span downhaul; this is particularly hazardous when the lead block has to be turned to take the downhaul to the winch or secure it to bitts or cleats.

19.16.4 The span downhaul should always be eased to a stopper and the stopper should take the weight before turns are removed from the winch, bitts or cleats.

19.17 Overhaul of cargo gear

19.17.1 When a cargo block or shackle is replaced, care should be taken to ensure that the replacement is of the correct type, size and SWL necessary for its intended use.

19.17.2 All shackles should have their pins effectively secured or seized with wire.

19.17.3 A special check should be made on completion of the work to ensure that all the split pins in blocks, etc. have been replaced and secured.

19.17.4 On completion of the gear overhaul, all working places should be cleaned of oil or grease.

19.18 Trucks and other vehicles/appliances

19.18.1 When vehicles/work trucks or other mechanical appliances are used aboard a vessel to carry personnel, they should where possible be constructed so as to prevent them overturning, or they should be equipped or adapted to limit the risk to those carried, by one or more of the following protection measures:

- An enclosure for the driver.

- A structure ensuring that, should the vehicle overturn, safe clearance remains between the ground and the parts of the vehicle where people are located when it is in use.
- A structure restraining the workers on the driving seat so as to prevent them from being crushed. These protection structures may be an integral part of the vehicle/work equipment. They are not required when the work equipment is stabilised or where the equipment design makes rollover impossible.

19.18.2 Personnel other than the driver should not be carried on a truck unless it is constructed or adapted for the purpose. Riding on the forks of a fork-lift truck is particularly dangerous. The driver should be careful to keep all parts of the body within the limits of the width of the truck or load.

19.18.3 Trucks for lifting and transporting should be used only by competent persons and only when the ship is in still water; they should never be used when vessels are in a seaway.

19.18.4 Appliances powered by internal combustion engines should not be used in enclosed spaces unless the spaces are adequately ventilated. The engine should not be left running when the truck is idle.

19.18.5 When not in use or left unattended whilst the vessel is in port, trucks for lifting and transporting should be aligned along the length of the ship with brakes on, operating controls locked and, where applicable, the forks tilted forward flush with the deck and clear of the passageway. If the trucks are on an incline, their wheels should be chocked. If not to be used for some time, and at all times whilst at sea, appliances should be properly secured to prevent movement.

19.18.6 No attempt should be made to handle a heavy load by the simultaneous use of two trucks. A truck should not be used to handle a load greater than its marked capacity or to move insecure or unsafe loads.

19.18.7 Tank containers should not be lifted directly with the forks of fork-lift trucks, because of the risks of instability and of damaging the container with the ends of the forks. Tank containers may be lifted using fork-lift trucks fitted with suitably designed side or top lifting attachments but care should be exercised because of the risk of surge in partly filled tanks.

19.19 Defect reporting and testing: advice to competent persons

19.19.1 There is a legal requirement for lifting plant to be tested every five years. This section provides advice to the competent person carrying out the test.

19.19.2 The requirements for testing a lifting plant will be met if before use one of the following appropriate tests is carried out:

- Proof loading the plant concerned.
- In appropriate cases, testing a sample to destruction.
- In the case of re-testing after repairs or modifications, such a test that satisfies the competent person who subsequently examines the plant (the re-testing of a ship's lifting appliance may be effected by means of a static test, e.g. by dynamometer where appropriate).

19.19.3 Where proof loading is part of a test, the test load applied should exceed the SWL as specified in the relevant standard or, in other cases, by at least the following:

Proof load (tonnes)

SWL (tonnes)	Lifting appliances	Single-sheave cargo and pulley blocks	Multi-sheave cargo and pulley blocks	Lifting beams and frames, etc.	Other lifting gear
0–10	SWL × 1.25	SWL × 4	SWL × 2	SWL × 2	SWL × 2
11–20	SWL × 1.25	SWL × 4	SWL × 2	SWL × 1.04 + 9.6	SWL × 2
21–25	SWL + 5	SWL × 4	SWL × 2	SWL × 1.04 + 9.6	SWL × 2
26–50	SWL + 5	SWL × 4	SWL × 0.933 + 27	SWL × 1.04 + 9.6	SWL × 1.22 + 20
51–160	SWL × 1.1	SWL × 4	SWL × 0.933 + 27	SWL × 1.04 + 9.6	SWL × 1.22 + 20
160+	SWL × 1.1	SWL × 4	SWL × 1.1	SWL × 1.1	SWL × 1.22 + 20

Note: Where a lifting appliance is normally used with a specific removable attachment and the weight of that attachment is not included in the marked SWL, then for the purposes of using the above table the SWL of that appliance should be taken as being the marked SWL plus the weight of the attachment.

19.19.4 Any defect found in any lifting plant, including plant provided by a shore authority, should be reported immediately to the master or to another responsible person who should take appropriate action.

19.19.5 Similar principles apply to cargo-securing devices as to lifting equipment. The crew and persons employed for the securing of cargoes should be instructed in the correct application and use of the cargo-securing gear on board the ship. For guidance on the securing of cargoes and handling of security devices, refer to the ship's approved cargo-securing manual.

19.20 Personnel-lifting equipment, lifts and lift machinery

19.20.1 Except under the conditions required by paragraph 19.20.2, no lifting equipment shall be used for lifting persons unless it is designed for the purpose.

19.20.2 If in exceptional circumstances it is necessary to use lifting equipment, which has not been specifically designed for the purpose, to lift persons:

- the control position of the lifting equipment must be manned at all times; and
- the persons being lifted must have a reliable means of communication, whether direct or indirect, with the operator of the lifting equipment.

19.20.3 Lifting equipment that is designed for lifting persons must not be used for that purpose unless it has been constructed, maintained and operated such that a worker may use it or carry out work activities from the carrier without risk to their health and safety, and in particular that:

- the worker will not be crushed, trapped or struck, especially through inadvertent contact with objects;
- the lifting equipment is so designed or has suitable devices:
 - to prevent any carrier falling or, if that cannot be prevented for reasons inherent in the site and height differences, the carrier has an enhanced safety coefficient suspension rope or chain;
 - to prevent the risk of any person falling from the carrier; and
- any person trapped in the carrier in the event of an incident is not thereby exposed to danger and can be freed.

19.20.4 Any rope or chain provided under section 19.20.3, first part of second bullet point, is to be inspected by a competent person every working day.

19.20.5 Guidelines on the transfer of personnel is contained in Chapter 31, Ships serving offshore oil and gas installations, of this Code and in MGN 332(M+F).

19.21 Maintenance and testing of lifts

19.21.1 Before a lift is put into normal service, it must be tested and examined by a competent person and a certificate or report issued.

19.21.2 Regular examination must be carried out by a competent person at intervals not exceeding six months and a certificate or report issued. More detailed examination and testing of parts of the lift installation must be carried out at periodic intervals by the manufacturer or their representative.

19.21.3 A person chosen to act as a competent person must be over 18 years old and have such practical and theoretical knowledge and actual experience of the type of lift that they have to examine as will enable them to detect defects or weaknesses and to assess their importance in relation to the safety of the lift.

19.21.4 Details of the tests and examinations required for the issue of a certificate are given in British Standards and other equivalent standards. 'Thorough examination and testing of lifts: Simple guidance for lift owners' (INDG339) is also available from the Health and Safety Executive (HSE).

19.21.5 An initial risk assessment must be made to identify hazards associated with work on each lift installation, including work requiring access to the lift trunk. Safe working procedures must be drawn up for each lift installation. Persons who are to be authorised to carry out work on or inspection of a lift installation must comply with these procedures.

19.21.6 The specific areas that the risk assessment should address should include, as appropriate:

- whether there are safe clearances above and below the car at the extent of its travel;
- whether a car-top control station is fitted and its means of operation; and
- the working conditions in the machine and pulley rooms.

19.21.7 Based on the findings of the risk assessment, a permit to work system should be used, as described in Chapter 14, Permit to work systems, when it is necessary for personnel to enter the lift trunk or to override the control safety systems. No person should work alone on lifts.

19.21.8 Any work carried out on lifts must only be performed by authorised persons familiar with the work and the appropriate safe-working procedures. These procedures must include provision for the safety of persons working on a lift and others who may also be at risk.

19.21.9 Appropriate safety signs must be prominently displayed in the area and also on control equipment such as call lift buttons. Barriers must be used when it is necessary for lift landing doors to remain open to the lift trunk.

19.21.10 Experience indicates that the most important single factor in minimising risk of accidents is the avoidance of misunderstandings between personnel. A means of communication to the authorising officer and between those involved in working on a lift must be established and maintained at all times. This might be by telephone, portable hand-held radio or a person-to-person chain. Whatever the arrangement, action should only be taken as a result of the positive receipt of confirmation that the message is understood.

19.21.11 Before attempting to gain access to the trunk of a lift, the mains switch should be locked in the OFF position (or alternatively the fuses should be withdrawn and retained in a safe place) and an appropriate safety sign positioned at the point of such isolation. This should include both main and emergency supplies. In addition, the landing doors should not be allowed to remain open longer than necessary; the machine room should be protected against unauthorised entry and, after completion of work, a check must be made to ensure that all equipment used in the operation has been cleared from the well.

19.21.12 When it is necessary for personnel to travel on top of a car, safety can be enhanced considerably by the use of the car-top control station (comprising a stopping device and an inspection switch/control device) required by British Standards or an equivalent standard. Account should be taken of the arrangement and location of the control station, i.e. whether the stopping device can be operated before stepping on to the car on top of the lift car if no stopping device is fitted.

Blank page

Annex 19.1 Certificates of testing and thorough examination of equipment

Annex 19.1.1

CERTIFICATE OF TEST AND THOROUGH EXAMINATION OF LIFTING APPLIANCES

Name of ship: _____ Certificate no.:

Official number: _____

Call sign: _____

Port of registry: _____

Name of owner: _____

(1) Situation and description of lifting application (with distinguishing numbers or marks, if any), which have been tested and thoroughly examined	(2) Angle to the horizontal or radius at which test load applied	(3) Test load (tonnes)	(4) Safe working load (SWL) at angle or radius shown in column (2) (tonnes)
---	--	------------------------	---

Name and address of the firm or competent person who witnessed testing and carried out thorough examination:

.....

.....

.....

.....

I certify that on the date to which I have appended my signature, the gear shown in column (1) was tested and thoroughly examined, and no defects or permanent deformation were found; and that the safe working load is as shown.

Date:

Signature:

Place:

Note: This certificate is the standard international form as recommended by the International Labour Office in accordance with ILO Convention No. 152.

Annex 19.1.2

CERTIFICATE OF TEST AND THOROUGH EXAMINATION OF DERRICKS USED IN UNION PURCHASE

Name of ship:

Certificate no.:

Official number:

Call sign:

Port of registry:

Name of owner:

(1) Situation and description of derricks used in union purchase (with distinguishing numbers or marks, if any), which have been tested and thoroughly examined	(2) Maximum height of triangle plate above hatch coaming (m) or maximum angle between runners	(3) Test load (tonnes)	(4) Safe working load, SWL (U), when operating in union purchase (tonnes)
---	---	------------------------	---

Position of outboard preventer guy attachments: (a) forward/aft* of mast (m)
and

(b) from ship's centre line (m)

Position of inboard preventer guy attachments: (a) forward/aft* of mast (m)
and

(b) from ship's centre line (m)

* Delete as appropriate

Name and address of the firm or competent person who witnessed testing and carried out thorough examination:

.....

.....

.....

.....

I certify that on the date to which I have appended my signature, the gear shown in column (1) was tested and thoroughly examined and no defects or permanent deformation were found; and that the safe working load is as shown.

Date:

Signature:

Place:

Note: This certificate is the standard international form as recommended by the International Labour Office in accordance with ILO Convention No. 152.

Annex 19.1.3

CERTIFICATE OF TEST AND THOROUGH EXAMINATION OF LOOSE GEAR

Name of ship: _____ Certificate no.:

Official number: _____

Call sign: _____

Port of registry: _____

Name of owner: _____

Distinguishing number or mark	Description of loose gear	Number tested	Date of test	Test loaded (tonnes)	Safe working load (SWL) (tonnes)
-------------------------------	---------------------------	---------------	--------------	----------------------	----------------------------------

Name and address of makers or suppliers:

.....
.....
.....
.....

Name and address of the firm or competent person who witnessed testing and carried out thorough examination:

.....
.....
.....
.....

I certify that the above items of loose gear were tested and thoroughly examined and no defects affecting their SWL were found.

Date:

Signature:

Place:

Note: This certificate is the standard international form as recommended by the International Labour Office in accordance with ILO Convention No. 152.

Blank page

Annex 19.1.4

CERTIFICATE OF TEST AND THOROUGH EXAMINATION OF WIRE ROPE

Name of ship:

Certificate no.

Official number:

Call sign:

Port of registry:

Name of owner:

Name and address of makers or suppliers:

.....
.....
.....
.....

Nominal diameter of rope (mm):

Number of strands:

Number of wires per strand:

Core:

Lay:

Quality of wire (N/mm²):

Date of test of sample:

Load at which sample broke (tonnes):

Safe working load of rope (tonnes):

Intended use:

Name and address of the firm or competent person who witnessed testing and carried out thorough examination:

.....
.....
.....
.....

I certify that the above particulars are correct, and that the rope was tested and thoroughly examined and no defects affecting its SWL were found.

Date:

Signature:

Place:

Note: This certificate is the standard international form as recommended by the International Labour Office in accordance with ILO Convention No. 152.

Annex 19.2 Register of ships' lifting appliances and cargo-handling gear

Name of ship:
Official number:
Call sign:
Port of registry:
Name of owner:
Register number:
Date of issue:
Issued by:
Signature and stamp:

Note: This Register is the standard international form as recommended by the International Labour Office (ILO) in accordance with ILO Convention No. 152.

Part 1: Thorough examination of lifting appliances and loose gear

(1) Situation and description of lifting appliances and loose gear with distinguishing numbers or marks, if any) which have been thoroughly examined (see note 1)	(2) Certificate numbers	(3) Examination performed (see note 2)	(4) I certify that on the date to which I have appended my signature, the gear shown in column (1) was thoroughly examined and no defects affecting its safe working condition were found other than those shown in column (5) (date and signature)	(5) Remarks (to be dated and signed)

Note 1: If all the lifting appliances are thoroughly examined on the same date it will be sufficient to enter in column (1) 'All the lifting appliances and loose gear'. If not, the parts which have been thoroughly examined on the dates stated must be clearly indicated.

Note 2: The thorough examinations to be indicated in column (3) include:

- initial;
- 12-monthly;
- five-yearly;
- repair/damage; and
- other thorough examinations, including those associated with heat treatment.

Part 2: Regular inspections of loose gear

(1) Situation and description of loose gear (with distinguishing numbers or marks, if any) which has been inspected (see note 1)	(2) Signature and date of the responsible person carrying out the inspection	(3) Remarks (to be dated and signed)







Note 1: All loose gear should be inspected before use. However, entries need only be made when the inspection discloses a defect.



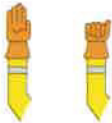





Blank page

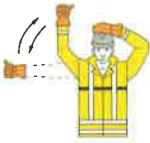





Annex 19.3 Code of hand signals

Preliminary remark: The following sets of coded signals are examples of those implemented by the EU Directive 92/58/EEC, but where there are accepted national signals in common use (as indicated*) these too are acceptable.

Visit the Health and Safety Executive (HSE) website on the link below to see these signs demonstrated in a video clip: www.hse.gov.uk/workplacetransport/safetysigns/banksman/banksman.htm

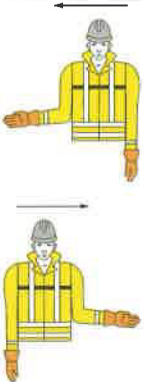
Meaning	Description	Illustration
	<i>A. General hand signals</i>	
START Attention Start of Command	Both arms are extended horizontally with the palms facing forward.	
TAKING THE STRAIN or INCHING THE LOAD	The right arm points upwards with the palm facing forwards. The fingers are clenched and then unclenched.	 *
STOP Interruption End of movement	The right arm points upwards with the palm facing forwards.	
END of the operation (operations cease)	Both hands are clasped at chest height.	
	OR	
	Both arms extended at 45° downwards and lower arms crossed back and forth sharply across torso.	 *
	<i>B. Vertical movements</i>	
RAISE	The right arm points upwards, with the palm facing forward, and slowly makes a circle.	
LOWER	The right arm points downwards, with the palm facing inwards, and slowly makes a circle.	

DERRICKING THE JIB	Signal with one hand. Other hand on head.	Jib up *  Jib down * 
TELESCOPING THE JIB	Signal with one hand. Other hand on head.	Extend jib *  Retract jib * 
VERTICAL DISTANCE	The hands indicate the relevant distance.	
<i>C. Horizontal movements</i>		
MOVE FORWARDS (Travel to me)	Both arms are bent with the palms facing upwards and the forearms make slow movements towards the body.	
MOVE BACKWARDS (Travel from me)	Both arms are bent with the palms facing downwards and the forearms make slow movements away from the body.	
RIGHT to the signalman's (in the direction indicated)	The right arm is extended more or less horizontally with the palm facing downwards and slowly makes small movements to the right.	

LEFT to the signalman's (in the direction indicated)	The left arm is extended more or less horizontally with the palm facing downwards and slowly makes small movements to the left.	
HORIZONTAL DISTANCE	The hands indicate the relevant distance.	
SLEWING (in the direction indicated)	Both arms close to side extending one arm 90° from elbow.	
	<i>D. Danger</i>	
DANGER EMERGENCY STOP	Both arms point upwards with the palms facing forwards.	
	<i>E. Other</i>	
SECURE	Secure the load: both arms are crossed closely to the chest with hands clenched.	
TWISTLOCKS Twistlocks on/off	The left arm points upwards. Rotate wrist of left hand clockwise signalling twist on, and anticlockwise for signalling twist off.	
	<i>F. Operating instructions</i>	
QUICK	All movements faster.	
SLOW	All movements slower.	

Blank page

CHAPTER 20

WORK ON MACHINERY AND POWER SYSTEMS

20.1 Introduction

20.1.1 Based on the findings of the risk assessment, before any maintenance work is carried out, appropriate control measures should be put in place to protect those seafarers concerned and others who may be affected. This chapter identifies some areas that may require attention.

20.2 General

20.2.1 No maintenance work or repair that may affect the supply of water to the fire main or sprinkler system should be started without the prior permission of the master and chief engineer.

20.2.2 No alarm system should be isolated without the permission of the master and chief engineer.

20.2.3 Means of access to firefighting equipment, emergency escape routes and watertight doors should never be obstructed.

20.2.4 Safety guards on machinery or equipment should only be removed when the machinery is not operating. If removal is essential for maintenance or examination of the equipment, the following precautions should be taken:

- Removal should be authorised by a responsible person, and only a competent person should carry out the work or examination.
- There should be adequate clear space and lighting for the work to be done.
- Anyone working close to the machinery should be told what the risks are and instructed in safe systems of work and precautions to take.
- A warning notice should be conspicuously posted.

20.2.5 Whenever floor plates or handrails are removed, warning notices should be posted, the openings should be effectively fenced or guarded and the area well illuminated. Floor plates and handrails should be secured in place on completion of the work being undertaken.

20.2.6 Lifting handles should be used when a floor plate is removed or replaced. When lifting handles are not provided, the plate should be levered up with a suitable tool and a chock inserted before lifting. On no account should fingers be used to prise up the edges.

20.2.7 Solvents used for cleaning can be toxic and they should always be used in accordance with the manufacturer's instructions. The area should be well ventilated, and smoking prohibited.

20.3 Work in machinery spaces

*S.I. 2006/2183
and MGN
331(M+F)*

20.3.1 Every dangerous part of a ship's machinery or other equipment should have guards or protection devices to prevent access to danger zones or to halt movements of dangerous parts before the danger zones are reached. Guidance is given in marine guidance note MGN 331(M+F).

20.3.2 All steam pipes, exhaust pipes and fittings, which by their location and temperature present a hazard, should be adequately lagged or otherwise shielded. The insulation of hot surfaces should be properly maintained, particularly in the vicinity of oil systems. This can be monitored through thermographic survey or the use of infra-red thermometers to ensure that surface temperatures do not exceed 220°C.

20.3.3 Seafarers required to work in machinery spaces that have high noise levels should wear suitable hearing protection (see section 8.6).

20.3.4 Where a high noise level in a machinery space, or the wearing of ear protectors, may mask an audible alarm, a visual alarm of suitable intensity should be provided, where practicable, to attract attention and indicate that an audible alarm is sounding. This should preferably take the form of a light or lights with rotating reflectors. Guidance may be found in the International Maritime Organization (IMO) Code on Alerts and Indicators.

20.3.5 The source of any oil leakage should be located and repaired as soon as practicable.

S.I. 1996/2154

20.3.6 Waste oil should not be allowed to accumulate in the bilges or on tank tops. Any leakage of fuel, lubricating or hydraulic oil should be disposed of in accordance with Merchant Shipping (Prevention of Oil Pollution) Regulations 1996 at the earliest opportunity. Tank tops and bilges should, wherever practicable, be painted a light colour and kept clean and well illuminated in the vicinity of pressure oil pipes so that leaks may be readily located.

20.3.7 Extreme caution is required when filling any settling or other oil tank to prevent it overflowing, especially in an engine room where exhaust pipes or other hot surfaces are directly below. Manholes or

other openings in the tanks should always be secured so that if a tank is overfilled the oil is directed to a safe place through the overflow arrangements.

20.3.8 Particular care should be taken when filling tanks that have their sounding pipes in the machinery spaces to ensure that weighted cocks are closed. In no case should a weighted cock on a fuel or lubricated oil tank sounding pipe or on a fuel, lubricating or hydraulic oil tank gauge be secured in the open position.

20.3.9 Engine room bilges should at all times be kept clear of rubbish and other substances so that mud-boxes are not blocked and the bilges may be readily and easily pumped.

20.3.10 Remote controls fitted for stopping machinery or pumps, or for operating oil-tank quick-closing valves in the event of fire, should be tested regularly to ensure that they are functioning satisfactorily. This also applies to the controls on fuel storage daily service tanks (other than double bottoms) and lubricating oil tanks.

20.3.11 Cleaning solvents should always be used in accordance with manufacturers' instructions and in an area that is well ventilated.

20.3.12 Care should be taken to ensure that spare gear is properly stowed and items of machinery under overhaul are safely secured so that they do not break loose and cause injury or damage even in the heaviest weather.

MSC.1/Circ.1321

20.3.13 Procedures should be in place to identify defects caused by vibration, fatigue, poor components and poor fitting of the fuel system and to ensure that protection of hot surfaces is maintained.

20.3.14 A supply of tools necessary for the tasks expected of personnel working in the engine room should be maintained in a location that minimises the distance a loaded tool box is likely to need transporting and, as much as possible, avoids the necessity of carrying tools up and down ladders.

MSC/Circ.834

20.3.15 A supply of personal protective equipment and consumables (such as light bulbs, flashlights, batteries, rags, log books and stationery) should be maintained close to the engine room for the use of the personnel working there.

20.4 Unmanned machinery spaces

20.4.1 Seafarers should never enter or remain in an unmanned machinery space alone, unless they have received permission from or been instructed by the engineer officer in charge at the time. They may only be sent to carry out a specific task that they may be expected to complete in a comparatively short time. Before entering the space, at regular intervals whilst in the space and on leaving the space, they must

report by telephone, or other means provided, to the duty deck officer (see also section 20.4.4). Before they enter the space, the method of reporting should be clearly explained. Consideration should be given in appropriate instances to using a permit to work (see section 14.2).

20.4.2 If it is the engineer officer in charge who enters the machinery space alone, they too should report to the deck officer before entry, at regular intervals whilst in the space and on leaving the space.

20.4.3 Notice of safety precautions to be observed by seafarers working in unmanned machinery spaces should be clearly displayed at all entrances to the space. Warning should be given that in unmanned machinery spaces there is a likelihood of machinery suddenly starting up.

20.4.4 If there is a personnel alarm system in place, reporting at regular intervals may be omitted. A personnel alarm is a system that will indicate a person's presence and their well-being in unmanned machinery spaces. Vessels without a personnel alarm system should have additional guidance recorded in the safety management system.

20.4.5 Unmanned machinery spaces should be adequately illuminated at all times.

20.4.6 When machinery is under bridge control, the bridge should always be advised when a change in machinery setting is contemplated by the engine room staff, and before a reversion to engine room control of the machinery.

20.5 Maintenance of machinery

20.5.1 Before machinery is serviced or repaired, measures should be taken to prevent it being turned on or started automatically or from a remote-control system.

- Electrically operated machinery should be isolated from the power supply.
- Steam-operated machinery should have both steam and exhaust valves securely closed, the valves locked or tied shut or some other means employed to indicate that the valves should not be opened. The same care is required when dealing with heated water under pressure as is required when working on steam-operated machinery or pipework.
- In all cases, warning notices should be posted at or near the controls giving warning that the machinery concerned is not to be used.
- Hydraulic-operated machinery should have its own oil supply valve isolated and the oil return valve if fitted.

20.5.2 The cleaning or replacement of fuel or lubricating filter elements on engines or turbines should, so far as practicable, only be undertaken with the engine or turbine in the stopped condition. Where valves or filter covers have to be removed or similar operations have to be performed on pressurised systems, that part of the system should be isolated by closing the appropriate valves. The position of a duplex filter change over cock does not guarantee that the 'out of service' filter chamber has been isolated. The drain and/or vent cocks should be opened gradually to ensure that pressure is off the system before any other fastenings or bolts are slackened off.

20.5.3 When joints of pipes, fittings, etc. are being broken, the fastenings should not be completely removed until the joint has been broken and it has been established that no pressure remains within.

20.5.4 Before a section of a steam pipe system is opened to the steam supply, all drains should be opened. Steam should be admitted very slowly and the drains kept open until all the water has been expelled.

Blank page

20.5.5 Maintenance or repairs to, or immediately adjacent to, moving machinery should be permitted only in circumstances where no danger exists or where it is impracticable for the machinery to be stopped. Close-fitting clothing should be worn and long hair should be covered (see section 8.5.5). The officer in charge should consider whether it is necessary in the interests of safety for a second person to be in close attendance whilst the work is being carried out.

20.5.6 Heavy parts of dismantled machinery temporarily put aside should be firmly secured against movement in a seaway and, as far as practicable, be clear of walkways. Sharp projections on them should be covered when reasonably practicable.

20.5.7 Spare gear, tools and other equipment or material should never be left lying around, especially near to stabiliser or steering gear rams, switchboards and batteries.

20.5.8 A marlin spike, steel rod or other suitable device should be used to align holes in machinery being reassembled or mounted; fingers should never be used.

20.5.9 When guards or other safety devices have been removed from machinery, they should be replaced immediately once the work is completed and before the machinery or equipment is tested.

20.5.10 An approved safety lamp should always be used for illuminating spaces where oil or oil vapour is present. Vapour should be dispersed by ventilation before work is done.

20.6 Boilers and thermal oil heaters

20.6.1 Boilers should be opened only under the direction of an engineering officer. Care should be taken to check, after emptying, that the vacuum is broken before manhole doors are removed. Even if an air cock has been opened to break the vacuum, the practice should always be to loosen the manhole door nuts and break the joint before the removal of the dogs and knocking in the doors. The top manhole doors should be removed first. Seafarers should stand clear of hot vapour when doors are opened.

20.6.2 Seafarers should not enter any boiler, boiler furnace or boiler flue until it has cooled sufficiently to make work in such places safe.

20.6.3 Before entry is permitted to a boiler that is part of a range of two or more boilers, the engineer officer in charge should ensure that either:

- all inlets through which steam or water might enter the boiler from any other part of the range have been disconnected, drained and left open to atmosphere; or

- where that is not practicable, all valves or cocks, including blowdown valves controlling entry of steam or water, have been closed and securely locked, and notices posted to prevent them being opened again until authorisation is given.

The above precautions should be maintained as long as seafarers remain in the boiler.

20.6.4 Seafarers cleaning tubes, scaling boilers and cleaning backends should wear appropriate protective clothing and equipment including respirators. The Company should also ensure that seafarers familiarise themselves with the accompanying datasheet to any chemical agents they may use in the course of their work. They should also be aware of the potentially hazardous gaseous by-products that may be produced from the reaction of the cleaner/de-scaling product and the object itself or from products used together, because this may result in an asphyxiating, explosive or other hazardous atmosphere.

20.6.5 A boiler is enclosed and, therefore, potentially a dangerous space. Special care should be exercised before entry is made in a boiler that has not been in use for some time or where chemicals have been used to prevent rust forming. The atmosphere may be deficient in oxygen and tests should be carried out before any person is allowed to enter. See Chapter 15 for advice on entering dangerous (enclosed) spaces.

20.6.6 A notice should be displayed at each boiler setting out operating instructions. Information provided by the manufacturers of the oil-burning equipment should be displayed in the boiler room.

20.6.7 To avoid the danger of a blowback when lighting boilers, the correct flashing-up procedure should always be followed:

- There should be no loose oil on the furnace floor.
- The oil should be at the correct temperature for the grade of oil being used; if not, the temperature of the oil must be regulated before lighting is attempted.
- The furnace should be blown through with air to clear any oil vapour.
- The torch, specially provided for the purpose, should always be used for lighting a burner unless an adjacent burner in the same furnace is already lit; other means of ignition, such as the introduction of loose burning material into the furnace, should not be used. An explosion may result from attempts to relight a burner from the hot brickwork of the furnace.
- If all is in order, the operator should stand to one side, and the lighted torch should be inserted and fuel turned on. Care should be

taken that there is not too much oil on the torch that could drip and possibly cause a fire.

- If the oil does not light immediately, the fuel supply should be turned off and the furnace ventilated by allowing air to blow through for two or three minutes to clear any oil vapour before a second attempt to light is made. During this interval the burner should be removed and the atomiser and tip inspected to verify that they are in good order.
- If there is a total flame failure while the burner is alight, the fuel supply should be turned off.

20.6.8 The avenues of escape from the boiler fronts and firing spaces should be kept clear.

20.6.9 Where required to be fitted, the gauge glass cover should always be in place when the glass is under pressure. If a gauge glass or cover needs to be replaced or repaired, the gauge should be shut off and drained before the cover is removed.

20.6.10 The same isolating and maintenance principles should be applied to thermal oil heaters and systems as those required for boilers. However, as the venting and drainage systems are closed systems to the thermal oil header tank or thermal oil drain tank respectively, additional care must be taken when isolating heaters to ensure that the system is fully drained and no residual pressure remains, before fittings are removed or pipes disconnected.

20.6.11 On completion of work on thermal systems, care must be taken to prevent water and moisture being introduced to the system. The steam produced, its sudden expansion and the significantly greater volume occupied may cause damage to equipment and significant disruption to the system as a whole. Before the system is refilled from the thermal oil header tank, the header tank drain should be tested for the presence of water. This should also be done whenever the header tank is refilled from the thermal oil drain tank or thermal oil storage tank.

20.7 Auxiliary machinery and equipment

20.7.1 Before starting work on an electric generator or auxiliary machine, the machine should be stopped and the starting air valve or similar device should be secured so that it cannot be operated. A notice should be posted warning that the machine is not to be started nor the turning gear used. To avoid the danger of motoring and electric shock to any person working on the machine, it should be isolated electrically from the switchboard or starter before work is commenced. The circuit breaker should be opened and a notice posted at the switchboard

warning seafarers that the breaker is **not** to be closed. Where practicable, the circuit breaker should be locked open and/or access prevented.

20.7.2 No attempt should be made to start a diesel engine without first barring round with the indicator cocks open. The barring gear should then be disengaged before starting the engine.

20.7.3 Oily deposits of flammable material should never be allowed to build up in the way of diesel engine relief valves, crankcase explosion doors or scavenge belt safety discs.

20.7.4 Flammable coatings should never be applied to the internal surfaces of air starting reservoirs.

20.7.5 When testing a diesel engine fuel injector or other high-pressure parts of injection equipment, jets should be contained so that they are not allowed to spray onto any part of the body.

20.7.6 Oxygen should on no account be used for starting engines. To do so would probably cause a violent explosion.

20.8 Main engines

20.8.1 Where necessary, suitable staging, which is adequately secured, should be used to provide a working platform.

20.8.2 Before anyone is allowed to enter or work in the main engine crankcase or gear case, the engine-starting system must be in local control and fully isolated with starting air drains opened to atmosphere. Turning gear should be engaged and a warning notice posted at the start position and turning gear local control. Turning gear should be under the control of the person carrying out the work. The spaces should be well ventilated and the atmosphere tested.

20.8.3 Before the main engine turning gear is used, a check should be made to ensure that all seafarers are clear of the crankcase and any moving part of the main engine, and that the duty deck officer has confirmed that the propeller is clear.

20.8.4 If a hot bearing has been detected in a closed crankcase, the crankcase should not be opened until sufficient time has been allowed for the bearing to cool down; otherwise the entry of air could create an explosive air/oil vapour mixture.

20.8.5 The opened crankcase or gear case should be well ventilated to expel all flammable gases before any source of ignition, such as a portable lamp (unless of an approved safety type), is brought near to it.

20.8.6 Before the main engine is restarted, a responsible engineer officer should check that the shaft is clear and inform the duty deck officer who should confirm that the propeller is clear.

20.9 Refrigeration machinery and refrigerated compartments

20.9.1 No one should enter a refrigerated chamber for maintenance activities without first informing a responsible officer.

20.9.2 Seafarers charging or repairing refrigeration plants should fully understand the precautions to be observed when handling the refrigerant. Adequate information should be available on each vessel, laying down the operation and maintenance safeguards of the refrigeration plant, the particular properties of the refrigerant and the precautions for its safe handling.

20.9.3 The compartment or flat in which refrigeration machinery is fitted should be adequately ventilated and illuminated. Where fitted, both the supply and exhaust fans to and from compartments in which refrigeration machinery is situated should be kept running at all times. Inlets and outlets should be kept unobstructed. When there is any doubt as to the adequacy of the ventilation, a portable fan or other suitable means should be used to assist in the removal of toxic gases from the immediate vicinity of the machine.

20.9.4 Should it be known or suspected that the refrigerant has leaked into any compartments, no attempt should be made to enter those compartments until a responsible officer has been advised of the situation. If it is necessary to enter the space, the procedures for entry into dangerous (enclosed) spaces should be followed (see Chapter 15, Entering dangerous (enclosed) spaces).

20.9.5 When refrigerant plants are being charged through a charging connection in the compressor suction line, it is sometimes the practice to heat the cylinder to evaporate the last of the liquid refrigerant. This should only be done by placing the cylinder in hot water or some similar indirect method and never by heating the cylinder directly with a blow lamp or other flame. Advice on the handling and storage of gas cylinders is given in section 24.8.

20.9.6 If it is necessary for repair or maintenance to apply heat to vessels containing refrigerant, appropriate valves should be opened to prevent build-up of pressure within the vessels.

20.10 Steering gear

20.10.1 Generally, work should not be done on steering gear when a ship is under way. If it is necessary to work on steering gear when the vessel is at sea, the ship should be stopped and suitable steps taken to immobilise the rudder by closing the valves on the hydraulic cylinders or by other appropriate and effective means.

20.11 Hydraulic and pneumatic equipment

20.11.1 Before repairs to or maintenance of hydraulic and pneumatic equipment is undertaken, any load should be removed or, if this is not practical, adequately supported by other means. All pressure in the system should be released. The part being worked upon should be isolated from the power source and a warning notice displayed by the isolating valve, which should be locked.

20.11.2 Precautions should be taken against the possibility of residual pressure being released when unions or joints are broken.

20.11.3 Absolute cleanliness is essential for the proper and safe operation of the hydraulic and pneumatic system; the working area and tools, as well as the system and its components, should be kept clean during servicing work. Care should also be taken to ensure that replacement units are clean and free from any contamination, especially fluid passages.

20.11.4 Only replacement components that comply with manufacturers' recommendations should be used. Any renewed or replacement item of equipment should be properly inspected or tested before being put into operation within the system.

20.11.5 Since vapours from hydraulic fluid may be flammable, naked lights should be kept away from hydraulic equipment that is being tested or serviced.

20.11.6 A jet of hydraulic fluid under pressure should never be allowed to spray onto parts of the body. If a person is subjected to hydraulic fluid under high pressure on unprotected skin, immediate medical assistance should be sought. Any hydraulic fluid spilt on the skin should be thoroughly washed off.

20.12 Electrical equipment

20.12.1 The risks of electric shock are much greater on board ship than they are normally ashore because wetness, high humidity and high temperature (including sweating) reduce the contact resistance of the body. In those conditions, severe and even fatal shocks may be caused

at voltages as low as 60V. It should also be borne in mind that cuts and abrasions significantly reduce skin resistance.

20.12.2 A notice of instructions on the treatment of electric shock should be posted in every place containing electrical equipment and switchgear. Immediate on-the-spot treatment of an unconscious patient is essential.

20.12.3 Before any work is done on electrical equipment, fuses should be removed or circuit breakers opened to ensure that all related circuits are dead. If possible, switches and circuit breakers should be locked open or, alternatively, a 'not to be closed' notice attached. Where a fuse has been removed, it should be retained by the person working on the equipment until the job is finished. A check should be made that any interlocks or other safety devices are operative. Additional precautions are necessary to ensure safety when work is to be undertaken on high-voltage equipment (designed to operate at a nominal system voltage in excess of 1000V). The work should be carried out by, or under the direct supervision of, a competent person with sufficient technical knowledge and a permit to work system should be operated.

20.12.4 Some parts of certain types of equipment may remain live even when the equipment is switched off. Power should always be cut off at the mains.

20.12.5 Flammable materials should never be left or stored near switchboards.

20.12.6 Work on or near live equipment should be avoided if possible but when it is essential for the safety of the ship or for testing purposes, the following precautions should be taken:

- A second person, who should be competent in the treatment of electric shock, should be continually in attendance.
- The working position adopted should be safe and secure to avoid accidental contact with the live parts. Insulated gloves should be worn where practicable.
- Contact with the deck, particularly if it is wet, should be avoided. Footwear may **not** give adequate insulation if it is damp or has metal studs or rivets. The use of a dry insulating mat at all times is recommended.
- Contact with bare metal should be avoided. A hand-to-hand shock is especially dangerous. To minimise the risk of a second contact should the working hand accidentally touch a live part, one hand should be kept in a trouser pocket whenever practicable.

- Wrist watches, metal identity bracelets and rings should be removed. They provide low-resistance contacts with the skin. Metal fittings on clothing or footwear are also dangerous.

20.12.7 Any test meters used should be rated for the voltage being tested with meter probes having only minimum amounts of metal exposed and insulation of both probes should be in good condition. Care should be taken that the probes do not short circuit adjacent connections. When measuring voltages that are greater than 250V, the probe should be attached and removed with the circuit dead.

20.13 Main switchboards

20.13.1 The internal cleaning and maintenance of the main switchboard must only be carried out while it is in a 'dead' condition; after a full risk assessment has been carried out, as described in Chapter 1, Managing occupational health and safety, and a formal permit to work issued, as described in Chapter 14, Permit to work systems.

20.13.2 The risk assessment will identify the actions and checks required to make the switchboard safe, and these actions and checks will be identified in the permit to work. The major checks to be listed on the permit to work will identify and verify that the necessary inter-connections to and from, and/or within, the main switchboard are disconnected. These will include but are not limited to:

- the shore power supply;
- the emergency generator; and
- the emergency power supply.

20.13.3 The internal cleaning and internal maintenance of the main switchboard would, in general, be an integral part of a ship's dry-dock programme or that of an extended maintenance programme.

20.14 High-voltage systems

20.14.1 Additional precautions are necessary to ensure safety when work is to be undertaken on high-voltage equipment (designed to operate at a nominal system voltage in excess of 1000V).

20.14.2 Definitions

The following list defines the terms used with respect to the high-voltage equipment/installations.

Additional earth: An earth connection applied to apparatus after the application of a circuit main earth, normally applied at the point of work if not already fitted with a circuit main earth.

Approved: A type of form sanctioned for use by the superintendent/senior electrical engineer.

Authorised person: An authorising officer is appropriately trained and appointed in writing by the superintendent/electrical engineer to carry out work as permitted by these rules.

Caution notice: A notice conveying a warning against interference with the apparatus to which it is attached.

Chief engineer: A senior engineer on board the vessel who is responsible for all vessel technical operations and maintenance.

Circuit main earth: An earth connection applied for the purpose of making apparatus safe to work on before a permit to work or sanction for test is issued, and which is nominated on the document.

Competent person: Someone who is appropriately trained and has sufficient technical knowledge or experience to enable them to avoid danger. It is the duty of the authorising officer issuing a permit to work covered by these rules to satisfy themselves that persons are competent to carry out the work involved.

Danger notice: A notice calling attention to the danger of approach or interference with the apparatus to which it is attached.

Dead: At or about zero voltage and disconnected from all sources of electrical energy.

Earthed: Connected to the general mass of earth in such a manner as will ensure at all times an immediate discharge of electrical energy without danger.

Electro-technical officer: A specialist electronic engineer who is competent to work on high-voltage systems.

High voltage: A voltage exceeding 1000 volts.

High-voltage apparatus: Any apparatus, equipment or conductors normally operated at a voltage higher than 1000 volts.

Isolated: The disconnection and separation of the electrical equipment from every source of electrical energy in such a way that the disconnection and separation are secure.

Key safe: A device for the secure retention of keys used to lock means of isolation, earthing or other safety devices.

Limitation of access: A form issued by an authorising officer to a competent person, defining the limits of the work to be carried out in the vicinity of, but not on, high-voltage electrical apparatus.

Live: Electrically charged from a supply of electricity.

Permit to work (in this section): A form of declaration signed and given by an authorising officer to a competent person in charge of the work to be carried out on or in close proximity to high-voltage apparatus, making known to the competent person the extent of the work, exactly what apparatus is dead, is isolated from all live conductors, has been discharged and earthed and, insofar as electric hazards are concerned, on which it is safe to work.

Safety lock: A lock used to secure points of isolation, safety devices and circuit earths, being unique from any other locks used on the system.

Sanction for test (in this section): A form of declaration, signed and given by an authorising officer to another authorising officer in charge of testing high-voltage apparatus, making known to the recipient what apparatus is to be tested and the conditions under which the testing is to be carried out.

Superintendent/senior electrical engineer: A senior electrical/mechanical engineer suitably qualified and appointed in writing by the Company to be responsible for compilation and administration of rules for high-voltage installations and operations.

Switching plan: A plan or programme, developed by the authorised person, which details the intended sequence of switching, isolation and earthing operations required to be carried out to isolate and make dead, or reinstate and make live, high-voltage equipment or installation. The plan must be agreed between the authorised person and the competent persons undertaking the task prior to executing the plan. If contractors are involved, then their agreement is also required.

20.14.3 Work on high-voltage equipment/installations

No work shall be carried out on high-voltage equipment/installations unless an agreed switching plan has been developed and implemented so that the equipment/installations are:

- dead;
- isolated and all practicable steps have been taken to lock off live conductors, voltage transformers (except where the connections are bolted) and dead conductors that may become live;

- earthed at all points of disconnection of high-voltage supply and caution notices attached in English and any other working language of the vessel; and
- released for work by the issue of a permit to work or a sanction for test.

Also, the competent person designated to carry out the work should fully understand the nature and scope of the work to be carried out and have witnessed a demonstration that the equipment/installation is dead at the point of work.

A limitation of access instruction should be used to give written instructions defining the limits of work to be carried out in the vicinity of **but not on** high-voltage equipment/installations.

On completion of work and on clearance and cancellation of the relevant permit to work, a switching plan should be developed for the removal of earthing and isolations leading to connecting to the high-voltage supply. It should be noted that a reversal of the plan used to isolate the equipment may lead to a dangerous or unsafe situation and it is always best practice to develop a plan for this considering the dead equipment or network as a starting point.

20.14.4 Operation of switchgear

Routine high-voltage switching shall only be carried out by a person competent to do so and in the normal course of their duties, using the equipment provided for the purpose.

High-voltage switching undertaken to isolate equipment for maintenance, inspection and/or testing, shall only be carried out by an authorised person or a competent person acting in the presence of and to the instructions of a person so authorised. The sequence of switching, isolation and earthing is to be carried out in accordance with an agreed switching plan.

In an emergency, high-voltage switching to cut off supply may be carried out by any person competent to do so.

Any message relating to the operation of the high-voltage system that has been transmitted by telephone/radio shall be repeated in full by the recipient and confirmed by the sender to ensure that the message has been accurately received.

Making live or dead by signals or a pre-arranged understanding after an agreed time interval is not permitted.

20.14.5 Withdrawn apparatus

High-voltage apparatus that has been isolated and removed from its normal operating position may be worked on without a permit to work or sanction for test, provided that:

- it has been discharged;
- it is prevented by barriers and locking from being restored to a live position; and
- access to high-voltage conductors on the switchboard is prevented.

20.14.6 Locking off

All spout (orifice) shutters not required for immediate work or operations shall be locked shut. (Exception: on certain types of switchgear, access to the shutters is restricted whilst the circuit breaker is still in the cubicle. Under these circumstances, it is acceptable to lock either the cubicle door or the racking mechanism, whichever is appropriate, which must prevent further withdrawal of the circuit breaker, so long as the circuit breaker has been withdrawn from its normal operating position.)

20.14.7 Protective equipment

Protective equipment associated with the high-voltage equipment/ installations and forming part of the system shall not be adjusted or put into or taken out of commission without the sanction of the chief engineer or superintendent/senior electrical engineer.

High-voltage equipment/installations shall not be commissioned or re-commissioned (after major work) until the protective devices have been proved to be functioning correctly.

20.14.8 Insulation testing

All high-voltage equipment/installations that are either new or have undergone substantial maintenance or alteration shall be subject to a high-voltage test in accordance with figures approved in writing by the chief engineer or superintendent/electrical engineer.

20.14.9 Failure of supply

During failures of supply, all apparatus, equipment and conductors shall be regarded as being live until isolated and proved dead.

20.14.10 Entry to enclosures containing high-voltage equipment/ installations

Compartments and other enclosures containing high-voltage apparatus shall be locked except when entry or exit is necessary.

The keys giving normal access to such enclosures shall be accessible to authorising officers only.

No person except an authorising officer, or a competent person who is under the immediate supervision of an authorising officer, who shall be continuously present, shall enter any enclosure in which it is possible to touch exposed high-voltage conductors.

Entry to compartments or other enclosures containing high-voltage equipment/installations is limited to authorising officers or other persons only when accompanied by an authorising officer.

Entry to compartments containing high-voltage equipment/installations that are not protected by insulated covers should only be undertaken when the equipment/installations are isolated and earthed.

20.14.11 Earthing

Circuit mains earths shall be applied and removed only by an authorising officer or a person competent to do so in the authorising officer's presence and to their instructions.

When high-voltage equipment/installations have been made dead and isolated, the conductors to be earthed shall be proved dead if practicable using an approved potential indicator. The potential indicator should be in date for calibration and be tested immediately before and after use, to prove it is in good working order.

Where practicable, circuit main earths shall be applied through a circuit breaker or earthing switches.

Before closing to earth, the trip features shall be rendered inoperative unless this is impracticable. After closing, the circuit breaker shall be locked in the earth position and the trip features rendered inoperative with a caution notice attached.

Additional earths may be applied at the point of work after the issue of a permit to work by the competent person in charge of the work.

Circuit main earths/additional earths may also be removed/replaced at the point of work after the issue of a sanction for test by the authorised person conducting the test.

A circuit main earth applied at the point of work may be removed and replaced one phase at a time to facilitate the work, provided this instruction is recorded on the permit to work. If this is the only circuit main earth connected to the apparatus, then a person authorised to issue permits to work shall remain at the point of work and be responsible for the safety of all those engaged in the work whilst the circuit main earth is

removed. No other simultaneous work shall be permitted on any part of the circuit during the validity of this permit to work.

20.14.12 Notices

Caution notices and danger notices shall be applied to all high-voltage equipment/installations covered by a permit to work or sanction for test calling attention to non-interference or danger as appropriate.

20.14.13 Work on high-voltage cables

No person shall touch the insulation that covers or supports any conductor subject to high voltage unless the conductor is earthed.

Before a permit to work is issued, a person authorised to issue permits shall identify the cable to be worked on and proven dead at the point of work. All cables shall be assumed to be live high-voltage cables until proven otherwise.

Before issuing a permit to work to cut into or disturb the insulation of a high-voltage cable (except as required below) the person who is to issue the permit to work shall ensure compliance with the following and, where practicable, shall involve the recipient of the permit to work:

- Check cable records.
- Visually trace the cable from the point of work to a point where the apparatus is clearly identified by permanent labelling and in such a way that there is no doubt about the cable identity.
- Where this is not practicable, then the cable shall be identified by signal injection methods; the cable shall be spiked with an approved spiking gun as near to the point of work as practicable. When practicable, the cable shall be cut with the spiking gun in position; tests shall be made to confirm the cable cut is the correct one. All this shall be carried out under a sanction for test.
- Where work is to be carried out on cables where the conductors and/or sheath may be subject to induced voltages from live equipment in close proximity, then where practicable the conductors and/or sheath shall be earthed and appropriate personal protective equipment (PPE) used.

Where the aforementioned procedures are not practicable, then a special procedure shall be written and approved by the chief engineer or electro-technical officer.

20.14.14 Work on transformers

When work is to be carried out on any connections up to a point of isolation or the windings of a transformer, all windings irrespective of

voltage shall be isolated. Circuit main earths shall be applied at the points of isolation from high-voltage supply. Low-voltage points of isolation shall be locked open.

20.14.15 Work on ring main units

The design of ring main units usually prevents the use of a potential indicator, prior to earthing. It is, therefore, extremely important that before any earth is applied the appropriate remote end is isolated first.

The system diagram should be checked prior to any operations and the onsite labelling noted on an approved switching procedure prior to commencing operations.

All work and switching on ring main units must be carried out in strict accordance with the manufacturer's instructions.

Work within the switching chamber of the ring main unit may require the isolation and earthing of all remote ends of the ring main unit.

20.14.16 Work on busbars and directly connected busbar equipment.

Before any work commences on a busbar or section of busbar, including any directly connected equipment, the busbar shall be isolated from any point of supply, including voltage transformers; any directly connected cable shall be isolated and earthed at the remote end.

All switches on the busbar or section of busbar shall be withdrawn to their isolated position.

All isolating arrangements are to be locked with shutters covering high-voltage contacts. Contacts that may become alive and contacts where no work is to be done shall be locked shut and warning notices posted.

The busbar or section of the busbar to be worked on shall be proved dead with an approved potential indicator in accordance with the rules for earthing (section 20.14.11).

A circuit main earth shall be applied to the busbar on at least one switch panel on the section of busbar on which work is to be done. An additional circuit main earth shall be applied at any remote ends of directly connected equipment.

An additional circuit main earth shall be applied at any such other position necessary to ensure that the busbar remains earthed at all times while work is being carried out.

A separate permit to work or sanction for test shall be issued in respect of each section of busbar. No more than one permit to work or sanction

for test shall be issued simultaneously in respect of any section of busbar or any electrical equipment directly connected to it.

Any orifices where work is to be done must be proved dead immediately beforehand by the use of an approved potential indicator.

20.15 Arc-flash associated with high- and low-voltage equipment

MGN 452(M)

20.15.1 An arc-flash occurs when an electric current flows through an air gap. The air is the conductor and an arc can form between phase-to-ground (neutral) or phase-to-phase and is accompanied by ionisation of the surrounding air.

20.15.2 The incident energy associated with an arc-flash is measured in calories per square centimetre (cal/cm^2). It is the amount of thermal energy from an arc flash that reaches a surface, such as a person's skin.

20.15.3 The greater the incident energy value is, the more severe the burn injury. The energy required to produce the onset of a second-degree burn is $1.2 \text{ cal}/\text{cm}^2$ and this is the benchmark for personal protection. (A second-degree burn affects both the outer and underlying layer of skin and causes pain and redness, swelling and blistering (National Institutes of Health (NIH), 2010).)

20.15.4 The goal of arc-flash protection is to minimise the likelihood of burn injury by providing an adequate thermal barrier that will limit the energy exposure of a person's skin to no more than $1.2 \text{ cal}/\text{cm}^2$. It is important to keep in mind that $1.2 \text{ cal}/\text{cm}^2$ is where the onset of a second-degree burn can occur, so there is still a possibility of being injured while protected.

20.16 Storage batteries: general

20.16.1 When a battery is being charged it 'gases', giving off both hydrogen and oxygen. As hydrogen is easily ignited in concentrations ranging from 4% to 75% in air, battery containers and compartments should be kept adequately ventilated to prevent an accumulation of dangerous gas.

20.16.2 Smoking and any type of open flame should be prohibited in a battery compartment. A conspicuous notice to this effect should be displayed at the entrance to the compartment.

20.16.3 Lighting fittings in battery compartments should be properly maintained at all times, with protective glasses in position and properly tightened. If cracked or broken glasses cannot be replaced immediately, the electric circuit should be isolated until replacements are obtained.

20.16.4 No unauthorised modifications or additions should be made to electrical equipment (including lighting fittings) in battery compartments.

20.16.5 Portable electric lamps and tools, and other portable power tools that might give rise to sparks, should not be used in battery compartments.

20.16.6 The battery compartment should not be used as a store for any materials or gear not associated.

20.16.7 A short circuit of even one cell may produce an arc or sparks that may cause an explosion of any hydrogen present. Additionally, the very heavy current that can flow in the short-circuiting wire or tool may cause burns due to rapid overheating of the metal.

20.16.8 Insulation and/or guarding of cables in battery compartments should be maintained in good condition.

20.16.9 All battery connections should be kept clean and tight to avoid sparking and overheating. Temporary clip-on connections should never be used because they may work loose due to vibration and cause a spark or short circuit.

20.16.10 Metal tools, such as wrenches or spanners, should never be placed on top of batteries because they may cause sparks or short circuits. The use of insulated tools is recommended.

20.16.11 Jewellery, watches and rings, etc. should be removed when working on batteries. A short circuit through any of these items will heat it rapidly and may cause a severe skin burn. If rings cannot be removed, they should be heavily taped in insulating material.

20.16.12 The battery chargers and all circuits fed by the battery should be switched off when leads are being connected or disconnected. If a battery is in sections, it may be possible to reduce the voltage between cells in the work area, and hence the severity of an accidental short circuit or electric shock, by removing the jumper leads between sections before work is begun. It should be appreciated that whilst individual cell voltages may not prevent a shock risk, dangerous voltages can exist when numbers of cells are connected together in series. A lethal shock needs a current of only tens of milliamps and particular care should be exercised when the voltage exceeds 50V.

20.16.13 The battery-charging systems should be checked to ensure that it is only possible to charge within the specified rate. Battery boxes should be checked for fixing and integrity as part of the planned maintenance.

20.16.14 Battery cell vent plugs should be screwed tight while connections are being made or broken.

20.16.15 The ventilation tubes of battery boxes should be examined regularly to ensure that they are free from obstruction.

20.16.16 Lids of battery boxes should be fastened while open for servicing and properly secured again when the work is finished.

20.16.17 Batteries should be kept battened into position to prevent shifting in rough weather.

20.16.18 Alkaline and lead-acid batteries should be kept in separate compartments or separated by screens. Where both lead-acid and alkaline batteries are in use, great care should be exercised to keep apart the materials and tools used in servicing each type, because contamination of the electrolyte may cause deterioration of battery performance and mixing of the two electrolytes produces a vigorous chemical reaction, which could be very dangerous.

20.16.19 Both acid and alkaline electrolytes are highly corrosive. Immediate remedial action should be taken to wash off any accidental splashes on the person or the equipment. Hands should always be washed as soon as the work is finished.

20.16.20 Batteries should always be transported in the upright position to avoid spillage of electrolyte. A sufficient number of people should be employed because the batteries are heavy and painful strains or injury can otherwise easily result (see Chapter 10, Manual handling).

20.17 Storage batteries: lead acid

20.17.1 When the electrolyte is being prepared, the concentrated sulphuric acid should be added **slowly** to the water. **If water is added to the acid, the heat generated may cause an explosion of steam, splattering acid over the person handling it.**

20.17.2 Goggles, rubber gloves and a protective apron should be worn when acid is handled.

20.17.3 To neutralise acid on skin or clothes, copious quantities of clean fresh water should be used.

20.17.4 An eyewash bottle should be to hand in the compartment for immediate use on the eyes in case of accident. This bottle should be clearly distinguishable by touch from acid or other containers, so that it may be easily located by a person who is temporarily blinded.

20.17.5 The corrosion products that form round the terminals of batteries are injurious to skin or eyes. They should be removed by brushing, away from the body. Terminals should be protected with petroleum jelly.

20.17.6 An excessive charging rate causes acid mist to be carried out of the vents onto adjacent surfaces. This should be cleaned off with diluted ammonia water or soda solution, and affected areas then dried.

20.18 Storage batteries: alkaline

20.18.1 The general safety precautions with this type of battery are the same as for the lead-acid batteries with the following exceptions.

20.18.2 The electrolyte in these batteries is alkaline but is similarly corrosive. It should not be allowed to come into contact with the skin or clothing, but in the case of an accident the affected parts should be washed with plenty of clean fresh water. Burns should be treated with boracic powder or a saturated solution of boracic powder. Eyes should be washed out thoroughly with water, followed immediately with a solution of boracic powder (at the rate of one teaspoonful to 1/2 litre or one pint of water). This solution should always be readily accessible when electrolyte is handled.

20.18.3 Unlike lead-acid batteries, metal cases of alkaline batteries remain live at all times and care should be taken not to touch them or allow metal tools to come into contact.

20.19 Work on apparatus on extension runners or on the bench

20.19.1 Chassis on extension runners should be firmly fixed, either by self-locking devices or by use of chocks, before any work is done.

20.19.2 Where units are awkward or heavy for one person to handle easily, assistance should be sought (see Chapter 10, Manual handling). Strain, rupture or a slipped disc can result from a lone effort.

20.19.3 Any chassis on the bench should be firmly wedged or otherwise secured to prevent it overbalancing or moving. Should a live chassis overbalance, no attempt should be made to grab it.

20.19.4 Temporary connections should be soundly made. Flexible extension cables should have good insulation and adequate current carrying capacity.

20.20 Servicing radio and associated electronic equipment: general

20.20.1 Any precautions against exposure to dangerous levels of microwave radiation recommended by manufacturers should be strictly followed. Radar sets should not be operated with wave guides disconnected.

20.20.2 Work should not be taken within the marked safety radius of a satellite terminal antenna unless its transmitter has been rendered inoperative.

20.20.3 Eyes are particularly vulnerable to microwave and ultraviolet radiation. Do not look directly into a radar aerial and waveguide while it is in operation or where arcing or sparking is likely to occur.

20.20.4 Exposure to dangerous levels of X-ray radiation may occur in the vicinity of faulty high-voltage valves. Care should be exercised when fault tracing in the modulator circuits of radar equipment. An open-circuited heater of such valves can lead to X-ray radiation where the anode voltage is in excess of 5000V.

20.20.5 Vapours of some solvents used for degreasing are toxic, particularly carbon tetrachloride, which should never be used. Manufacturers' instructions should be followed.

20.20.6 Some dry recorder papers used in echo sounders and facsimile recorders give off toxic fumes in use. The equipment should be well ventilated to avoid inhalation of the fumes.

20.20.7 Radio transmitters and radar equipment should not be operated when people are working in the vicinity of aerials; the equipment should be isolated from mains supply and radio transmitters earthed. When equipment has been isolated, warning notices should be placed on transmitting and radar equipment and at the mains supply point, to prevent apparatus being switched on until clearance has been received from those concerned that they have finished the outside work.

20.20.8 Aerials should be rigged out of reach of seafarers standing at normal deck level or mounting easily accessible parts of the superstructure. If that is impractical, safety screens should be erected.

20.20.9 Notices warning of the danger of high voltage should be displayed near radio transmitter aerials and lead-through insulators.

20.21 Additional electrical hazards from radio equipment

20.21.1 Where accumulators are used they should be disconnected at source; otherwise, precautions should be taken to prevent the short circuiting of the accumulator, with consequent risk of burns.

20.21.2 Live chassis connected to one side of the mains are usually marked appropriately and should be handled with caution. Where the mains are AC and a transformer is interposed, the chassis is usually connected to the earth side of the supply, but this should be verified using an appropriate meter.

20.21.3 Modern equipment often embodies a master crystal enclosed in an oven; the supply to the oven is taken from an independent source and is not disconnected when the transmitter is switched off and the mains switch is off. Mains voltage will be present inside the transmitter and care should be taken.

20.21.4 Before work is begun on the extremely high-tension section of a transmitter or other high-tension apparatus, with the mains switched off, all high-tension capacitors should be discharged using an insulated jumper, inserting a resistor in the circuit to slow the rate of discharge. This precaution should be taken even where the capacitors have permanent discharge resistors fitted.

20.21.5 An electrolytic capacitor that is suspect, or shows blistering, should be replaced, because it is liable to explode when electrical supply is on. There is a similar risk when an electrolytic capacitor is discharged by a short circuit.

20.21.6 Work at or near live equipment should be avoided if possible but where it is essential for the safety of the ship or for testing purposes then the additional precautions described in section 20.12.6 should be taken.

20.22 Valves and semi-conductor devices

20.22.1 Valves being removed from equipment that has recently been operating should be grasped with a heat-resistant cloth; in the case of large valves (e.g. power amplifier, output valves and modulators, which reach a high temperature in operation), the cooling-down time should be allowed before they are removed. Severe burns can result if they touch bare skin.

20.22.2 Cathode ray tubes and large thermionic valves should be handled with care; although they implode when broken, there is still a risk of severe cuts from sharp-edged glass fragments. Some special purpose devices contain vapour or gas at high pressure (e.g. Trigratron) but these are usually covered with a protective fibre network to contain the glass should they explode.

20.22.3 Beryllia (beryllium oxide) dust is very dangerous if inhaled or if it penetrates the skin through a cut or abrasion. It may be present in some electronic components. Cathode ray tubes, power transistors, diodes and thyristors containing it will usually be identified by the manufacturers' information provided, but lack of such information should not be taken as a positive indication of its absence. The heat sink washers that contain it are highly polished and look like dark brass. These items should be carefully stored in their original packaging until required.

20.22.4 Physical damage to components of this kind, whether they are new or defective, is likely to produce dangerous dust; abrasion should be avoided, they should not be worked by tools and encapsulations should be left intact. Excessive heat can be dangerous, but normal soldering with thermal shunt is safe. Damaged or broken parts should be separately and securely packed, following the manufacturer's instructions for return or disposal.

20.22.5 Seafarers handling parts containing beryllia should wear protective clothing, including gloves, to prevent the substance coming into contact with the skin. Tweezers should be used where practicable. If the skin does become contaminated with the dust, affected parts, particularly any cuts, should be cleaned without delay.

CHAPTER 21

HAZARDOUS SUBSTANCES AND MIXTURES

21.1 General advice

21.1.1 Many substances and mixtures found on ships are capable of damaging the health and safety of those exposed to them. They include not only substances displaying hazard-warning labels (particularly those declared as dangerous goods in ships' stores) but also, for example, a range of dusts, including hardwood dusts, fumes and fungal spores from goods, plant or activities aboard ship.

21.1.2 This chapter deals with the use of hazardous substances and mixtures (referred to in this chapter as 'hazardous substances') carried on board ships, e.g. in a ship's stores. Dangerous substances carried as cargo are covered in the relevant sections of Chapter 28, Dry cargo, and Chapter 29, Tankers and other ships carrying bulk liquid cargoes.

21.1.3 A hazard-warning label includes a pictogram, a precautionary statement, a hazard statement (e.g. carcinogenic, flammable) and, where required, a signal word (either 'Danger' or 'Warning'). Seafarers should familiarise themselves with the meaning of such labels.

21.1.4 The Company's risk assessment will identify where seafarers are working in the presence of hazardous substances, and evaluate any risks from exposure. Appropriate measures should be taken to remove, control or minimise the risk. It is essential before use of any hazardous substance that the manufacturer's safety data sheet (SDS) is referred to, to select appropriate personal protective equipment (PPE) and working methods.

21.1.5 The Company should instruct and inform seafarers so that they know and understand the risks arising from their work and the precautions to be taken. Employers should inform seafarers of the results of any monitoring of exposure.

21.1.6 Where possible, seafarers should avoid direct contact with hazardous substances, wear appropriate gloves and if necessary safety glasses/goggles, and follow the manufacturer's instructions.

21.1.7 The Company should instruct seafarers to take appropriate precautions and make them aware of the potentially hazardous by-products that may be produced from mixing hazardous substances

together, e.g. mixing chlorine-based toilet cleaner with de-scaler will evolve a hazardous gaseous by-product, which may result in an asphyxiating, explosive or other hazardous atmosphere.

21.1.8 The risk assessment will also provide information to determine whether health surveillance is appropriate as a result of exposure to hazardous substances. Advice can be found in Chapter 7, Health surveillance.

21.1.9 As an aid to the identification of hazards and the assessment of risks from hazardous substances, reference may be made to the SDS, which in Europe the manufacturer is required to supply with hazardous substances and mixtures.

21.1.10 For more specialist advice relating to particular work activities, reference may also be made where appropriate to the series of publications issued by the Health and Safety Executive (HSE) under the Control of Substances Hazardous to Health (COSHH) Regulations (see Appendix 2, Other sources of information).

21.2 Carcinogens and mutagens

*S.I. 2007/3100
and MGN
356(M+F)*

21.2.1 The Merchant Shipping and Fishing Vessels (Health and Safety at Work) (Carcinogens and Mutagens) Regulations 2007 (the 2007 Regulations) specifically require that the risk assessment considers the risk arising from exposure to carcinogens and mutagens. A carcinogen is a substance or mixture for which evidence exists to establish a link between exposure to it and the development of cancer, and a mutagen is a substance or mixture for which evidence exists to establish a link between exposure to it and heritable genetic damage.

21.2.2 Hazardous substances that are found on ships and considered carcinogens and mutagens include:

- aflatoxins;
- arsenic;
- asbestos (see section 21.4);
- hardwood dusts;
- rubber dust and rubber fumes; and
- used engine oils.

21.2.3 The supplier of a hazardous substance or mixture is required to:

- identify the hazards of the substance or mixture;

- provide information about the hazards to their customers. This information is usually provided on the package itself (e.g. by means of a hazard label) and, if supplied for use at work, in a SDS; and
- package the chemical safely (classification of carcinogens is described in Annex 21.1).

The hazard information should be used to help the Company comply with the 2007 Regulations.

21.2.4 Where the risk assessment reveals a risk to seafarers' health from carcinogens and mutagens, and the measures set out in section 21.3 do not result in the complete removal of that risk, the Company should ensure that in no circumstances does the exposure exceed the limit values set out in the regulations.

21.2.5 All cases of cancer that can be identified as resulting from occupational exposure to a carcinogen or mutagen, and have been confirmed in a report from a doctor, are required to be reported to the Maritime and Coastguard Agency (MCA). (See Chapter 7, Health surveillance, on the reporting of occupational diseases.)

21.3 Prevention or control of exposure

21.3.1 The first consideration should always be to prevent exposure by removing the substance, e.g. by substituting a less harmful one.

21.3.2 Where this is not reasonably practicable, prevention or control of exposure may be achieved by any combination of the following means:

- Total or partial enclosure of the process and handling systems.
- Using plant, processes and systems of work, which minimise the generation of, or suppress and contain/prevent, spills, leaks, dust fumes and vapours of hazardous substances.
- Limiting the quantities of a substance at the place of work.
- Keeping the number of persons who might be exposed to a substance to a minimum, and reducing the period of exposure.
- Prohibiting eating, drinking and smoking in areas that may be contaminated by the substance.
- Hygiene measures, including providing adequate washing and laundering facilities, and regular cleaning of walls/bulkheads and other surfaces.
- Designation of those areas that may be contaminated and the use of suitable and sufficient warning signs.

- Safe storage, handling and disposal of hazardous substances and use of closed and clearly labelled containers.
- Using appropriate procedures for the measurement of hazardous substances, in particular for the early detection of abnormal exposures resulting from an unforeseeable event or an accident.
- Taking individual/collective protection measures.
- Where appropriate, drawing up plans to deal with emergencies likely to result in abnormally high exposure.

21.3.3 These measures should be applied to reduce the risk to seafarers to the minimum, but where they do not adequately control the risk to health, PPE should be provided in addition.

21.3.4 The Company should take reasonable steps to ensure that any control measures are properly used and maintained. Where appropriate, exposure levels should be monitored and recorded. For some hazardous substances, seafarers must not be subject to exposure at work beyond a statutory level. These workplace exposure limits are published by HSE in the publication, 'EH40/2005 Workplace exposure limits', available on the HSE website.

21.3.5 Seafarers should comply fully with the control measures in force.

21.3.6 For certain substances (e.g. asbestos and benzene), very specific control measures apply. In cases where failure of the control measures could result in risk to health and safety, the exposure of personnel should be monitored and a record kept for future reference.

21.3.7 Where the adequacy or efficiency of control measures is in doubt, work should not be undertaken until outside advice is sought and action taken proportionate to the risks involved.

21.4 Asbestos dust

*S.I. 2010/2984,
MGN 429(M+F)
and MGN
493(M+F)*

21.4.1 The use of asbestos in ship construction has been banned internationally, but cases of its use are still being discovered in non-approved parts such as gaskets and brake linings. Caution should be exercised when obtaining spare parts, because some components may contain asbestos even when declared 'asbestos free'. Measures to protect seafarers' health where there is a risk of exposure to asbestos are in the Merchant Shipping and Fishing Vessels (Health and Safety at Work) (Asbestos) Regulations 2010 and associated marine guidance notes (MGNs).

21.4.2 All types of asbestos have a fibrous structure and can produce harmful dust if the surface exposed to the air is damaged or disturbed.

The danger is not immediately obvious because the fibres that can damage the lungs and cause lung cancer are too small to be seen with the naked eye. Asbestos that is in good condition is unlikely to release fibres, but where the material is damaged or deteriorating, or work is undertaken on it, airborne fibres can be released. Dry asbestos is much more likely to produce dust than asbestos that is thoroughly wet or oil-soaked. Asbestos is particularly likely to occur on older vessels in insulation and panelling, but certain asbestos compounds may also be found elsewhere and on other vessels in machinery components such as gaskets and brake linings.

21.4.3 The Company should advise masters of any location where asbestos is known or believed to be present on their ship. Masters and/or safety officers should keep a written record of this information and should also note any other position where asbestos is suspected, but they should not probe or disturb any suspect substance. Crew members who work regularly near asbestos or a substance likely to contain it should be warned of the need for caution and should report any deterioration in its condition such as cracking or flaking.

21.4.4 The condition of old asbestos may deteriorate and where reasonably practicable consideration should be given to its removal. This should be carried out in port and a specialist removal contractor should be used to ensure adequate protective procedures. Where the port is in the UK and the work involves asbestos insulation or asbestos coating, it is usually necessary for the contractor to hold a licence issued by HSE. If such work is carried out outside the UK, the contractor should be of equivalent competence.

21.4.5 If it is essential to carry out emergency repairs liable to create asbestos dust while the ship is at sea, strict precautions, including the use of the appropriate protective clothing and respiratory protective equipment, should be observed in accordance with the guidance given in the relevant merchant shipping notice (MSN). See also the general guidance on the assessment and control of risks from hazardous substances in section 3.11 of this Code.

21.4.6 Where asbestos or asbestos-containing materials are carried as a cargo, generally in shipping containers, extreme caution should be exercised so as to prevent exposure.

21.5 Use of chemical agents

21.5.1 Relevant MGNs give further guidance on the handling of chemicals and should be consulted. Particular emphasis is given to health monitoring for those exposed to chemicals (see Chapter 7, Health surveillance).

*S.I. 2010/330,
MGN 409(M+F)
and MGN
454(M+F)*

21.5.2 A chemical from an unlabelled package or receptacle should never be used unless its identity has been positively established. In addition to transport labelling, packaged substances supplied in Europe may also display similar or additional labelling for supply and use for compliance with the European regulation on classification, labelling and packaging of substances and mixtures ('the CLP Regulation').

21.5.3 Employers should ensure workers are instructed to familiarise themselves with the accompanying data sheet for any chemical agents they may use in the course of their work. They should also be aware of the potentially hazardous gaseous by-products that may be produced from the reaction of a cleaner/de-scaling product and the object itself, or products used together, because this may result in an asphyxiating, explosive or other hazardous atmosphere.

21.5.4 Chemicals should always be handled with the utmost care. Industrial formulations may be stronger. Eyes and skin should be protected from accidental exposure or contact.

21.5.5 Manufacturers' or suppliers' advice on the correct use of chemicals should always be followed. Some cleaning agents (e.g. caustic soda and bleaches), even though used domestically, may burn the skin. The product's hazard-warning label should identify where skin corrosion/serious eye damage hazards are present. Instructions on handling such chemicals safely will be made clear in the precautionary statements.

21.5.6 Chemicals should not be mixed unless it is known that no dangerous reaction will be caused.

21.5.7 Employers should ensure that any necessary training in the use of chemicals is given.

21.6 Dry-cleaning operations

21.6.1 The principal hazard presented by a dry-cleaning solvent is that it is highly volatile, producing a vapour that is anaesthetic. Effective mechanical ventilation should therefore be provided in any compartment containing dry-cleaning plant. Smoking should be prohibited in compartments when the solvent is present.

21.6.2 Dry-cleaning solvent is also a potential cause of skin damage and suitable PPE should be worn.

21.6.3 A competent person should be appointed to take overall responsibility for the security and operation of the dry-cleaning plant and access should be controlled.

21.7 Safe use of pesticides

*S.I.1999/336 and
MSN 1718(M)*

21.7.1 The following guidance should be read in conjunction with MSN 1718(M), which has mandatory force under the Merchant Shipping (Carriage of Cargoes) Regulations 1999.

MSC.1/Circ.1264

21.7.2 Where pesticides are used in the cargo spaces of ships or cargo units, safety procedures should be in accordance with the International Maritime Organization (IMO) publication, MSC.1/Circ.1264, and a copy of this publication should be retained on board and kept accessible for all crew members.

MSC.1/Circ.1358

Where pesticides are used in other spaces of ships, safety procedures should be in accordance with MSC.1/Circ.1358.

21.7.3 Where space and surface-spraying operations are being carried out by the crew, the master should ensure that the appropriate protective clothing, gloves, respirators and eye protection are being worn.

21.7.4 The ship's personnel should not handle fumigants and such operations should be carried out only by qualified operators. Fumigation should only be carried out with the authority of the ship's master. (Health and safety guidance on fumigation can be found in the HSG251 publication, which is available from the HSE website.)

21.7.5 In exceptional circumstances, the master may choose to allow an in-transit fumigation only after first referring to the requirements of the ship's own national administration, and seeking the approval of the administration of the state of the vessel's next destination or port of call. The master should provide safe working conditions and ensure that at least two members of the crew, including one certificated officer, have received the appropriate training. They should be familiar with the recommendations of the fumigant manufacturer concerning the methods of detection of the fumigant in air, its behaviour and hazardous properties, symptoms of poisoning, relevant first-aid treatment and special medical treatment and emergency procedures.

21.7.6 The 'fumigation warning' sign should be conspicuously displayed on cargo units or spaces under fumigation. A watchman should be posted to prevent access to areas of risk by unauthorised personnel.

21.8 Biological agents

*S.I. 2010/323 and
MGN 408(M+F)*

21.8.1 The following guidance should be read in conjunction with MGN 408(M+F) on biological agents. Biological agents are classified in groups 1 to 4. These groups are defined in Annex 21.1.

21.8.2 In excess to the guidance given above, employers are required to keep a list of those exposed to biological agents of group 3 or higher.

21.8.3 Any worker involved with the handling of, or being exposed to, biological agents should be given appropriate training and advice.

21.8.4 Before any work is carried out, a risk assessment should be carried out and procedures put in place for any potential accident to minimise its effects.

21.8.5 The most likely areas for contamination by biological agents are from the following:

- food preparation;
- contact with animals and/or products of animal origin;
- health care;
- work with air-conditioning and water-supply systems; and
- work involving waste disposal and the sewage plant.

21.9 Solid carbon dioxide

21.9.1 Solid carbon dioxide (drikold, cardice, dry ice) can be used as an emergency refrigerant for preserving deep frozen food supplies in their hard frozen condition.

21.9.2 The following precautions should be taken when solid carbon dioxide is used:

- Carbon dioxide does not diffuse readily, because it is heavier than air, therefore, special care should be taken to test the atmosphere thoroughly and ventilate such compartments/enclosed spaces before entering.
- The door of the compartments/enclosed spaces should remain open while the seafarer is inside the cold chambers/enclosed spaces.
- Gloves should always be worn when handling solid carbon dioxide to prevent blistering of the skin.

21.9.3 Chapter 15 gives guidance on entering dangerous (enclosed) spaces and the procedures that should be followed prior to entry and while inside.

Annex 21.1 Classification of carcinogens and biological agents

Classification of carcinogens

Carcinogenic category 1	Substances known to cause cancer on the basis of human experience.
Carcinogenic category 2	Substances that it is assumed can cause cancer on the basis of reliable animal evidence.
Carcinogenic category 3	Substances where there is only evidence in animals and it is of doubtful relevance to human health, i.e. the evidence is not good enough for categories 1 or 2.

In the case of **mutagens**, there are three similar categories with analogous descriptors, based on the strength of evidence for heritable genetic damage.

All categories should be treated as hazardous substances or mixtures.

Classification of biological agents

Group 1	Unlikely to cause human disease.
Group 2	Can cause human disease and may be a hazard to employees; it is unlikely to spread to the community and there is usually effective prophylaxis or treatment available.
Group 3	Can cause severe human disease and may be a serious hazard to employees; it may spread to the community, but there is usually effective prophylaxis or treatment available.
Group 4	Causes severe human disease and is a serious hazard to employees; it is likely to spread to the community and there is usually no effective prophylaxis or treatment available.

Blank page

CHAPTER 22

BOARDING ARRANGEMENTS

22.1 Introduction

S.I. 1997/2962

22.1.1 Safe means of access must be provided between the ship and the shore or another ship alongside which the ship is secured. Providing safe access to and from a ship is considered to be an integral part of ensuring a safe working environment on board, as required by the Merchant Shipping and Fishing Vessels (Health and Safety at Work) Regulations 1997, regulation 5(2)(e). Following the principles and guidance in this chapter will generally be considered to demonstrate compliance with the duty to ensure a safe working environment on board ship. Where different measures are taken to provide a safe means of access, these alternative measures must provide at least an equivalent level of safety in the operating conditions at the time.

22.1.2 This chapter sets out general principles that must be complied with, and best practice guidance. It highlights some areas that may require attention in respect of boarding arrangements.

22.2 General principles

22.2.1 Arrangements for boarding should be provided that are fit for purpose, comply with the appropriate standards in this chapter and are properly maintained in accordance with section 22.7.

22.2.2 Gangways and accommodation ladders are to be considered as lifting equipment and should be tested and recorded as such.

*IMO MSC.1/
Circ. 1331*

22.2.3 Where the provision of equipment is necessary to ensure safe means of access, it must be placed in position promptly, be properly rigged and deployed, safe to use and adjusted as necessary to maintain safe access. Rigging equipment should not form a trip hazard. Ships should comply with inspection, testing and maintenance requirements.

22.2.4 The means of access should be inspected to ensure that it is safe to use after rigging. There should be further checks to ensure that adjustments are made when necessary due to tidal movements or change of trim and freeboard. Guard ropes, chains, etc. should be kept taut at all times and stanchions should be rigidly secured.

22.2.5 When access equipment is provided from the shore, it is still the responsibility of the master to ensure as far as is reasonably practicable that the equipment meets these requirements.

22.2.6 Any access equipment and immediate approaches to it must be adequately lit. For appropriate standards of lighting, see Chapter 11, Safe movement on board ship, Annex 11.2.

22.2.7 The means of boarding and its immediate approaches should be kept free from obstruction and, as far as is reasonably practicable, kept clear of any substance likely to cause a person to slip or fall. Where this is not possible, appropriate warning notices should be posted and if necessary the surfaces suitably treated.

22.2.8 Each end of a gangway or accommodation or other ladder should provide safe access to a safe place or to an auxiliary safe access.

22.2.9 A portable ladder should only be used for access to a ship when no safer access is reasonably practicable. A rope ladder should only be used between a ship with a high freeboard and a ship with a low freeboard or between a ship and a boat if no safer means of access is reasonable practicable.

22.2.10 A lifebuoy with a self-activating light and also a separate buoyant safety line attached to a quoit or some similar device must be provided ready for use at the point of access aboard the ship.

22.3 Safety nets

22.3.1 An adequate number of safety nets of a suitable size and strength are to be carried on the ship or otherwise be readily available. Where there is a risk of a person falling from the access equipment or from the quayside or ship's deck adjacent to the access equipment, a safety net must be mounted where reasonably practicable.

22.3.2 The aim of safety nets is to minimise the risk of injury arising from falling between the ship and the quay or falling onto the quay, deck or between two vessels. As far as is reasonably practicable, the whole length of the means of access should be covered. Safety nets should be securely rigged, with use being made of attachment points on the quayside where appropriate.

22.4 Use of equipment

S.I. 1997/2962

22.4.1 When suitable access equipment is provided from the ship or from the shore or from another ship, any person boarding or leaving the ship shall use that equipment.

22.5 Positioning of boarding equipment

22.5.1 The angles of inclination of a gangway or accommodation ladder should be kept within the limits for which it was designed.

22.5.2 When the inboard end of the gangway rests on or is flush with the top of the bulwark, a bulwark ladder should be provided. Any gap between the bulwark ladder and the gangway should be adequately fenced to a height of at least 1 metre.

22.5.3 Gangways and other access equipment should not be rigged on ships' rails unless the rail has been reinforced for that purpose. They should comply with the guidance in Annex 22.1.

22.5.4 The means of access should be sited clear of the cargo working area and so placed that no suspended load passes over it. Where this is not practicable, access should be supervised at all times.

22.5.5 When an accommodation ladder is being rigged, this should be completed with the ladder in the horizontal position so that those working on it can be safely attached with a safety line to the deck and the ladder secured to reduce any unnecessary movement.

22.6 Portable and rope ladders

22.6.1 Where, exceptionally, a portable ladder is used for the purpose of access to the ship, it is very important that the ladder is checked regularly by a competent person, and that account is taken of vessel movement and tide changes.

22.6.2 When it is necessary to use a portable ladder for access, it should be used at an angle of 75° from the horizontal. The ladder should extend at least 1 metre above the upper landing place unless there are other suitable handholds. It should be properly secured against slipping, shifting sideways or falling and be so placed as to afford a clearance of at least 150 mm behind the rungs.

22.6.3 When a portable ladder is resting against a bulwark or rails, there should be suitable safe access to the deck.

22.6.4 A rope ladder should be secured to a proper fixing point, and never to rails or to any other means of support unless they are constructed for the purpose.

22.6.5 A rope ladder should be left in such a way that it either hangs fully extended from a securing point or is pulled up completely. It should not be left so that any slack will suddenly pay out when the ladder is used.

22.6.6 Where the freeboard is 9 metres or more, a rope ladder should only be used in conjunction with an accommodation ladder, leading aft and positioned in such a way as to provide safe and easy access from the rope ladder to the bottom platform.

22.7 Maintenance of equipment for means of access

22.7.1 Any equipment used for boarding or for hoisting boarding equipment, including lifting wires, should be inspected by a competent person at appropriate intervals, properly maintained and parts renewed in accordance with the manufacturer's instructions. Additional checks should be made each time the equipment is rigged, looking out for signs of distortion, cracks or corrosion. Welding connections should be given particular attention in inspections.

22.7.2 Arrangements should be made to inspect the underside of gangways and ladders periodically. Any defects affecting the safety of any access equipment, including access provided by a shore authority, should be reported immediately to a responsible person and made good before further use.

22.7.3 Aluminium equipment should be examined for corrosion and fracture in accordance with the instructions in Annex 22.2.

22.7.4 All inspections, maintenance work and repairs should be recorded. The record should include the date of the most recent inspection, the name of the person or body carrying out the inspection, the due date for inspection and the dates for renewal of wires for supporting the equipment.

22.7.5 Gangways, accommodation ladders and winches used for lifting or access should be tested in the same way as all other lifting appliances and records maintained, including any test certificates.

22.8 Special circumstances

22.8.1 In some circumstances, it may not be practical to mount proper safe boarding arrangements by conventional means, e.g. where there is frequent movement of the ship during cargo operations, or where access is required between the ship and an offshore structure. On such occasions, boarding should be carefully supervised and consideration given to providing alternative means of access.

22.8.2 Further guidance on safe access to offshore structures is in Chapter 31, Ships serving offshore oil and gas installations.

22.8.3 Small boats or tenders used between the shore and the ship should be safe and stable for the expected conditions, suitably powered, correctly operated, properly equipped with the necessary safety equipment and, if not a ship's boat, approved for that purpose.

22.8.4 Where a vessel is moored alongside another vessel, there should be cooperation between the two vessels in order to provide suitable and safe boarding arrangements. Access should generally be provided by the ship lying outboard, except that, where there is a great disparity in freeboard, access should be provided by the ship with the higher freeboard.

22.8.5 Care should be taken at all times, but particularly at night, when boarding or leaving a ship, or when moving through the dock area. The edges of the docks, quays, etc. should be avoided and any sign prohibiting entry to an area should be strictly observed. Where there are designated routes they should be followed exactly. This is particularly important in the vicinity of container terminals or other areas where rail traffic, straddle carriers or other mechanical handling equipment is operating, because the operators of such equipment have restricted visibility, placing anyone walking within the working area at risk.

S.I. 2002/1473

22.8.6 Transfer of personnel between two unsecured ships at sea is potentially a particularly dangerous manoeuvre, and should be avoided where possible. Where such a manoeuvre is unavoidable, a risk assessment of the transfer arrangements should be undertaken and appropriate safety measures put in place to ensure the safety of those involved. Both vessels should be properly equipped and/or modified to allow the boarding to be undertaken without unnecessary risk. A proper embarkation point should be provided, and the boarding procedure clearly agreed. The relative movements of both vessels in any seaway and varying sea, tide and swell conditions make the judgement of when to effect a transfer crucial. The master responsible for the transfer operation should have full sight of the area of transfer and, with at least one designated crew member, be able to communicate at all times with the crew member making the transfer. It is recommended that vessels undertaking ship-to-ship transfers while under way should carry equipment designed to aid in the rapid recovery of a casualty from the waters.

22.8.7 A working lifejacket should be donned when there is a risk of falling into the water when transferring to a vessel or structure that is not alongside. The transfer of baggage or other items should be done by the crews of the vessels and not by those boarding.

22.9 Access for pilots

*S.I. 2002/1473 and
MSN 1734(M+F),
IMO Resolution
A.1045(27) and
BS ISO 799:2004*

22.9.1 The Company is required to provide pilot ladders and accommodation ladders that comply with the construction and testing requirements laid out in SOLAS Chapter V, regulation 23 as amended. Guidance on these standards is included in Annex 22.1.

22.9.2 In addition, the master must ensure the following:

- All pilot ladders used for pilot transfer should be clearly identified with tags or other permanent marking so as to enable identification of each appliance for the purposes of survey, inspection and record keeping. A record should be kept on the ship as to the date the identified ladder is placed into service and any repairs effected.
- Each pilot ladder, accommodation ladder and their associated equipment are properly maintained and stowed, and regularly inspected to ensure that, so far as is reasonably practicable, each is safe to use.
- Each pilot ladder is used only for the embarkation and disembarkation of pilots and by officials and other persons while a ship is arriving at or leaving a port.
- The rigging of the pilot ladder, accommodation ladder and associated equipment is supervised by a responsible officer who is in communication with the navigating bridge. This officer's duties will include arranging for the pilot to be escorted by a safe route to and from the bridge. Advice on safe rigging of such equipment is included in this chapter (see section 22.10).
- Personnel engaged in rigging or operating any mechanical equipment are instructed in the safe procedures to be adopted and that the equipment is to be tested prior to each use.

22.9.3 A safety line and harness, a lifebuoy with a self-igniting light, and a heaving line should be kept at hand ready for use at the point of boarding.

22.9.4 The pilot ladder, accommodation ladder and the position where the person embarks and disembarks on the ship should be adequately lit.

22.9.5 It is very important that the ship offers a proper lee to the pilot boat. The arrangements for boarding should preferably be sited as near amidships as possible, but in no circumstances should they be in a position that could lead to the pilot boat running the risk of passing underneath overhanging parts of the ship's hull structure. Further information is contained in marine guidance note MGN 301(M+F).

MGN 301(M+F)

22.10 Safe rigging of pilot ladders

22.10.1 In addition to the general points in section 22.2, in order to minimise the danger to pilots when boarding and leaving ships, particular attention should be given to the following points:

- Pilot ladders should be rigged in such a manner that the steps are horizontal, and such that the lower end is at a height above the water to allow ease of access to and from the attendant craft.
- The ladder should rest firmly against the side of the ship.
- When an accommodation ladder is used in conjunction with a pilot ladder, the pilot ladder should extend at least 2 metres above the bottom platform.
- Safe, convenient and unobstructed access should be provided to anyone embarking or disembarking between the ship and the head of the pilot ladder.
- A lifebuoy with self-igniting light should be kept available at the point of access to the ship.
- At night, the pilot ladder and ship's deck should be lit by a forward-shining, overside light.

See the 'Required boarding arrangements for pilot' diagram on the International Maritime Pilots' Association website, which is listed in Appendix 2, Other sources of information, of this Code.

22.11 Safe access to small craft

22.11.1 Ports and harbours may not have areas specifically designed to ensure safe access to and from small vessels. In determining how access will be provided, it is good practice to consider each of the options below, starting with gangways before moving to the next level. The most suitable means of access should be identified by risk assessment, considering which safety measures are required.

22.11.2 All these methods for gaining access to small craft can be used safely providing appropriate safety measures are taken.

22.11.3 The industry's recommended hierarchy of access arrangements for small craft, starting with the safest first, is as follows:

- Gangway between small craft and the quay, quay steps, quay wall, pier or other vessel/small craft.
- Stepping directly (short step, level access) between the small craft and the quay, quay steps, quay wall, pier, other vessel/small craft or pontoon.

SIP021

- Fixed ladder from the quay, quay wall, pier or jetty.
- Portable ladder between the small craft and the quay, quay wall, pier or jetty.

Annex 22.1 Standards for means of access

ISO 5488:1979,
ISO 7061:1993
MSC.1/Circ.1331
BS MA 89:1980

1. General

1.1 Accommodation ladders and gangways should comply with appropriate international standards such as ISO 5488:1979 Shipbuilding – accommodation ladders and ISO 7061:1993 Shipbuilding – aluminium shore gangways for seagoing vessels.

1.2 The structure of accommodation ladders and gangways and their fittings should allow regular inspection and maintenance of all parts and, where necessary, lubrication of their pivot pin. Each accommodation ladder or gangway should be clearly marked at each end with a plate showing any restrictions on safe operation or loading including minimum and maximum permitted design angles or inclination, design load and maximum load on the bottom end plate. Where the maximum operating load is less than the design load, that should also be shown on the marking plate.

1.3 Gangways should be carried on ships of 30 metres in length or over and accommodation ladders must be carried on ships of 120 metres in length or over, complying with the specifications in section 2. Access equipment must be of good construction, sound material and adequate strength, free from patent defect and properly maintained. Rope ladders must comply with the requirements in section 4.

1.4 Gangways and accommodation ladders must be clearly marked with the manufacturer's name, the model number, the maximum designed angle of use and the maximum safe loading, both by numbers of persons and by total weight.

2. Gangways

BS MA 78:1978

2.1 Gangways must comply with the specifications set out in standard BS MA 78:1978 or equivalent, and should be fitted with suitable fencing along their entire length.

2.2 They should not be used at an angle of more than 30° from the horizontal, unless designed and constructed for use at greater angles.

2.3 Gangways should not be fixed to the ship's railings unless designed for such use. If rigged in an open section in the ship's bulwark or railings, any remaining gaps should be adequately fenced.

3. Accommodation ladders

3.1 An accommodation ladder should be designed so that:

- it rests firmly against the side of the ship where practicable;
- the angle of slope is no more than 55°. Treads and steps should provide a safe foothold at the angle at which the ladder is used;
- it is fitted with suitable fencing (preferably rigid handrails) along its entire length, except that fencing at the bottom platform may allow access from the outboard side;
- at a maximum inclination, the lowest platform of the ladder is no more than 600 mm above the waterline in the lightest seagoing conditions;
- the bottom platform is horizontal, and any intermediate platforms are self-levelling;
- it provides direct access between the head of the ladder and the ship's deck by a platform securely guarded with guardrails and adequate handholds;
- it can easily be inspected and maintained; and
- it is rigged as close to the working area but clear of any cargo operations as possible.

*BA MA 39, Part 2;
1973*

SOLAS III/3.13

3.2 After installation, the winch and ladder should be operationally tested to confirm proper operation and condition of the winch and ladder after the test. This test should include raising and lowering the accommodation ladder at least twice (e.g. ISO 7364:1983). Records should be maintained, including any test certificates.

3.3 When a bulwark ladder is to be used, it must comply with the specifications set out in the Shipbuilding Industry Standard No. SIS 7 or BS MA 39, Part 2:1973 Specification for ships' ladders, or be of an equivalent standard. Adequate fittings must be provided to enable the bulwark ladder to be properly and safely secured.

ISO 7364:1983

*SOLAS
Chapter V.23,
S.I. 2002/1473,
MSN 1734(M+F)
and BS ISO
799:2004*

4. Pilot ladders

4.1 A rope ladder must be of adequate width and length and so constructed that it can be efficiently secured to the ship.

- The steps must provide a slip-resistant foothold of not less than 400 mm × 115 mm × 25 mm and must be so secured that they are firmly held against twist, turnover or tilt.
- The steps must be horizontal and equally spaced at intervals of 310 mm (± 5mm).

- The side ropes, which should be a minimum of 18 mm in diameter, should be equally spaced.
- There should be no shackles, knots or splices between rungs.
- Ladders of more than 1.5 metres in length must be fitted with spreaders not less than 1.8 metres long. The lowest spreader must be on the fifth step from the bottom and the interval between spreaders must not exceed nine steps. The spreaders should not be lashed between steps.

4.2 New or replacement pilot ladders fitted on or after 1 July 2012 should be certified by the manufacturer as being compliant with international standards and duly marked as being Marine Equipment Directive (MED) approved (EC Directive 96/98/EC of 20 December 1996 on marine equipment as amended). Merchant shipping notice MSN 1734(M+F) as amended provides more information. A pilot ladder (conforming to BS ISO 799:2004) can be accepted provided that it meets the regulation requirements.

4.3 In addition to the standards above, every pilot ladder should be positioned and secured so that:

- it is clear of any possible discharges from the ship;
- it is, where practicable, within the mid-ship half-section of the ship (but see section 22.9.5);
- it can rest firmly against the ship's side; and
- the person climbing it can safely and conveniently board the ship after climbing no more than 9 metres.

4.4 Where replacement steps are fitted, they should be secured in position by the method used in the original construction of the ladder. No pilot ladder should have more than two replacement steps secured in position by a different method. Where a replacement step is secured by means of grooves in the sides of the step, such grooves should be in the longer sides of the step.

4.5 Two man-ropes of not less than 28 mm in diameter, properly secured to the ship, should be provided.

4.6 Where access to the ship is by a gateway in the rails or bulkhead, adequate handholds should be provided. Shipside doors used for this purpose should not open outwards.

4.7 Where access is by bulwark ladder, the ladder should be securely attached to the bulwark rail or landing platform. Two handhold stanchions should be provided, between 700 mm and 800 mm apart,

each of which should be rigidly secured to the ship's structure at or near its base and at another higher point. The stanchions should be at least 40 mm in diameter and extend no less than 1.20 metres above the top of the bulwarks.

4.8 Where the freeboard of the ship is more than 9 metres, accommodation ladders must be provided on each side of the ship.

4.9 Such accommodation ladders should comply with the standards in paragraph 2.1 of this annex, and in addition:

- the pilot ladder should extend at least 2 metres above the accommodation ladder's bottom platform; and
- if a trap door is fitted in the bottom platform to allow access to the pilot ladder, the opening should be no less than 750 mm square, and the after part of the bottom platform should be fenced as the rest of the ladder. In this case, the pilot ladder should extend above the lower platform to the height of the handrail.

Annex 22.2 Corrosion and fractures of accommodation ladders and gangways

- Aluminium alloys are highly susceptible to galvanic corrosion in a marine atmosphere if they are used in association with dissimilar metals. Great care should be exercised when connecting mild steel fittings, whether or not they are galvanised, to accommodation ladders and gangways constructed of aluminium.
- Plugs and joints of neoprene, or other suitable material, should be used between mild steel fittings, washers, etc. and aluminium. The plugs or joints should be significantly larger than the fittings or washers.
- Repairs using mild steel doublers or bolts made of mild steel or brass or other unsuitable material should be considered temporary. Permanent repairs, or the replacement of the means of access, should be undertaken at the earliest opportunity.
- The manufacturer's instructions should give guidance on examination and testing of the equipment. However, close examination of certain parts of accommodation ladders and gangways is difficult because of their fittings and attachments.
- Aluminium welds are susceptible to fracture. Where fractures are found, these should be made good at the earliest opportunity.

It is essential, therefore, that the fittings are removed periodically for a thorough examination of the parts most likely to be affected by corrosion. Accommodation ladders and gangways should be turned over to allow for a thorough examination of the underside.

Particular attention should be paid to the immediate perimeter of the fittings; this area should be tested for corrosion with a wire probe or scribe. Where the corrosion appears to have reduced the thickness of the parent metal to 3 mm, back plates should be fitted inside the stringers of the accommodation ladder or gangways.

Blank page

CHAPTER 23

FOOD PREPARATION AND HANDLING IN THE CATERING DEPARTMENT

23.1 Health and hygiene

MSN 1845(M)

23.1.1 Catering staff should be properly trained in food safety and personal hygiene, as they are responsible for ensuring that high standards of personal hygiene and cleanliness are maintained at all times throughout the galley, pantry and mess rooms. Further guidance for food preparation is contained in merchant shipping notice MSN 1845(M). Where food is prepared outside the confines of the galley (e.g. food that is provided ready prepared by an outside caterer), equivalent precautions will have been applied at the premises where the food is cooked.

23.1.2 There should be no smoking in galleys, pantries, store rooms or other places where food is prepared or stored.

23.1.3 Hands and fingernails should be washed before handling food using a dedicated hand basin, a bacterial liquid soap from a dispenser and disposable towels. It is important to thoroughly wash and dry hands after using the toilet, blowing your nose or handling refuse or contaminated food. An alcohol gel may be used to supplement the use of soap and water.

23.1.4 All cuts, however small, should be reported immediately and first-aid attention provided to prevent infection.

23.1.5 An open cut, burn or abrasion should be covered with a blue waterproof dressing which must be changed regularly. Anyone with a septic cut or a boil, stye, etc. should stop working with food until it is completely healed.

23.1.6 Illness, coughs and colds, rashes or spots, however mild, should be reported immediately when the symptoms appear.

23.1.7 A person suffering from diarrhoea and/or vomiting, which may be signs of food poisoning or a sickness bug, should not work in food-handling areas until medical clearance has been given.

23.1.8 Catering staff should wear clean protective clothing, including appropriate protective gloves if necessary, when handling food and preparing meals.

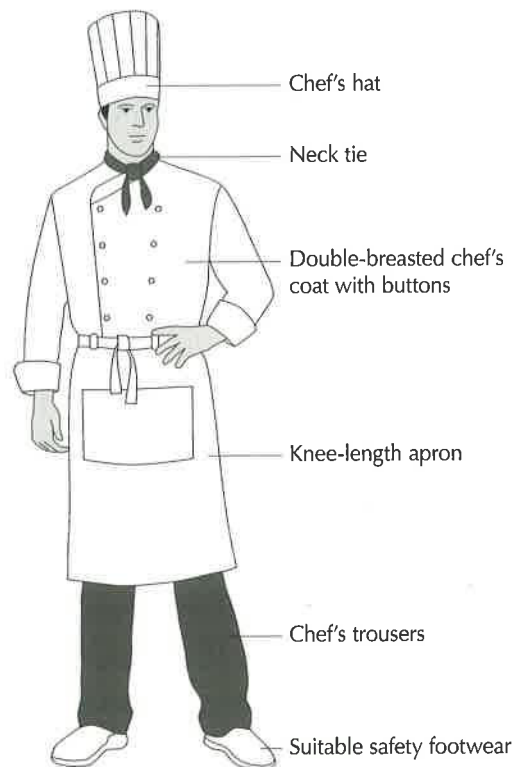

23.1.9 Catering staff should not wear jewellery, apart from a plain wedding band.

23.1.10 The cleanliness of all food, crockery, cutlery, linen, utensils, equipment and storage is vital. Cracked or chipped crockery and glassware should not be used. Foodstuffs that may have come into contact with broken glass or broken crockery should be thrown away.

23.1.11 Fresh fruit and salad should be thoroughly washed in fresh water before being eaten.

23.1.12 Foodstuffs and drinking water should not be stored where germs can thrive. Frozen food must be defrosted in controlled conditions, i.e. an area entirely separate from other foods in cool conditions. Food should be prevented from sitting in the thaw liquid by placing it on grids in a container or on a shelf. Frozen food that has been defrosted is not to be refrozen.

23.1.13 The risks of cross contamination should be eliminated by thoroughly stripping and cleaning the relevant parts of equipment when successive different foods are to be used (especially raw and cooked foods). It is important to wash hands after handling raw meat, fish, poultry or vegetables.

23.1.14 Raw food should be kept apart from cooked food or food that requires no further treatment before consumption (e.g. milk). Separate refrigerators are preferred although, if stored in the same unit, the raw food must always be placed at the bottom to avoid drips contaminating ready prepared food. Food should also be covered to prevent drying out, cross contamination and absorption of odour.

23.1.15 Separate work surfaces, chopping boards and utensils should be set aside for the preparation of raw meat and must not be used for the preparation of foods that will be eaten without further cooking. Colour coding is an established way of ensuring separation between the two activities.

23.1.16 Ensure all food is kept at the correct temperature to prevent the multiplication of bacteria.

23.1.17 Crockery and glassware should not be left submerged in washing up water where it may easily be broken and cause injury. Such items should be washed individually as should knives and any utensils or implements with sharp edges. Crockery, glassware and utensils should preferably be washed in a dishwasher, where much higher temperatures can be achieved compared with hand washing.

23.1.18 Some domestic cleaning substances contain bleach (sodium hypochlorite) or caustic soda (sodium hydroxide) whilst some disinfectants contain carbolic acid (phenol). These substances can burn the skin and they are poisonous if swallowed. They should be treated with caution and should not be mixed together or used at more than the recommended strength. Inadvertent contact with toxic chemicals or other harmful substances should be reported immediately and the appropriate remedial action taken. Cleaning substances and materials should be stored in a suitable locker/cupboard separate from food-handling areas. Wherever possible, cleaning products that are not injurious to individuals or the environment should be used.

23.1.19 Food waste, empty food containers and other garbage are major sources of pollution and disease and should be placed in proper covered storage facilities safely away from foodstuffs. Their discharge into the sea is prohibited except in circumstances specified in MSN 1807(M+F).

*MSN 1807(M+F),
S.I. 2008/3257*

23.2 Slips, falls and tripping hazards

23.2.1 Suitable footwear, with slip-resistant soles, should be worn at all times. A large proportion of injuries to catering staff arise because they wear unsuitable footwear such as sandals, plimsolls or flip-flops, which do not grip greasy decks or protect the feet from injury, burns or scalds if hot or boiling liquids are spilt.

23.2.2 Decks and gratings should be kept clear from grease, rubbish, ice, etc. to avoid slipping. Any spillage should be cleared up immediately.

23.2.3 Broken glass or crockery should be cleared away with a brush and pan and never with bare hands.

23.2.4 The area of deck immediately outside the entrance to refrigerated rooms should have an anti-slip surface.

23.2.5 Care should always be taken when using stairs and companionways; one hand should always be kept free to grasp the handrail.

23.2.6 Trays, crates, cartons, etc. should not be carried in such a fashion that sills, storm steps or other obstructions in the path are obscured from view.

23.2.7 Lifts that involve reaching up too high or too low should be avoided. Personnel should not stand on unsecured objects to reach articles which are out of reach.

23.3 Galley stoves, steamboilers and deep fat fryers

23.3.1 Ships using oil-fired stoves should operate safety procedures according to the manufacturer's instructions, particularly when lighting the stove. Instructions should be clearly displayed in the galley.

23.3.2 Catering staff should not attempt to repair electric or oil-fired ranges or electric microwave ovens. Defects should always be reported so that proper repairs may be made. The equipment should be kept out of use and a warning notice displayed until it has been repaired.

23.3.3 The indiscriminate use of water in hosing down and washing equipment in the galley can be very dangerous, particularly when there are electrical installations. Whenever the galley deck is washed down, power to an electric range and all electric equipment should be switched off and isolated from the supply, and water kept from contact with the electric equipment.

23.3.4 Range guardrails should always be used in rough weather. Pots and pans should never be filled to the extent that the contents spill over when the ship rolls.

23.3.5 All catering staff should be fully instructed in avoiding burns from hot surfaces on hot serving tables, bains-marie, steamers and tilting pans.

23.3.6 Dry cloths or pot holders and heatproof oven gloves that are long enough to cover the arms should always be used to handle hot pans and dishes. Wet cloths conduct heat quickly and may scald the hands.

23.3.7 No one should be directly in front of an oven when the door is opened – the initial heat blast can cause burns.

23.3.8 The steam supply to pressure cookers, steamers and boilers should be turned off and pressure released before their lids are opened.

23.4 Liquid petroleum gas appliances

23.4.1 Suitable means for detecting the leakage of gas should be provided and securely fixed in the lower part of the galley as gas is heavier than air. A gas detector should incorporate an audible and a visible alarm, and should be tested frequently. A suitable notice, detailing the action to be taken when an alarm is given by the gas detection system should be prominently displayed.

23.4.2 Equipment should be fitted, where practicable, with an automatic gas shut-off device which operates in the event of flame failure.

MGN 312(F)

23.4.3 When gas burning appliances are not in use, the controls should be turned off. If they are not going to be used again for some length of time, the main regulators close to the storage bottles should be shut. Marine guidance note MGN 312(F) gives further guidance on the safe operation of liquid petroleum gas appliances.

23.4.4 A safe system of working, training and supervision over lighting and operating procedures should be established.

23.4.5 Defects in joints, valves and connections can be detected by smell. Catering staff should not attempt to repair electric, oil or gas appliances.

23.5 Deep fat frying

23.5.1 Water should never be poured into hot oil; the water turns to steam, throwing the oil considerable distances. This may cause severe burns to personnel, and possibly start a fire.

23.5.2 If fat catches fire in a container, the flames should be smothered using a fire blanket if practicable and the container removed from the source of heat. Otherwise a suitable fire extinguisher should be used. In no circumstances should water be used.

23.5.3 Reference should be made to the manufacturer's safety data sheet (SDS) to establish the flash point of the cooking medium and then the thermostat(s) should be used to monitor the temperature to ensure this is not reached.

23.5.4 Deep fat fryers should be provided with suitable safety lids, which should be kept in position when the fryers are not in use.

23.5.5 To minimise the risk of fire from failure of the control thermostat, all deep fat fryers should be fitted with both a primary and a backup thermostat, with an alarm to alert the operator in the event of failure of either thermostat. The thermostats should be maintained and checked in accordance with the manufacturer's instructions.

23.5.6 Electrically operated deep fat fryers should be switched off immediately after use. Arrangements should be in place for automatically shutting off the electrical power upon activation of the fire extinguishing system.

23.5.7 A safe system of work for cleaning and draining fat fryers should be established.

23.5.8 A strict schedule of cleaning for galley uptakes/grills should be established so that fat deposits are not allowed to accumulate.

23.5.9 A notice should be displayed prominently, detailing the action to be taken in the event of a deep fat fryer fire.

23.6 Microwave ovens

23.6.1 When microwave ovens are used, it is important to ensure that the food is cooked thoroughly and evenly. This is particularly important with deep frozen foods, which should be thoroughly defrosted before cooking. The instructions issued by the oven manufacturers should be followed carefully, in conjunction with the information on the packaging of the foodstuff.

23.6.2 No microwave oven should be operated if the oven door or its interlock is out of use, the door broken or ill-fitting or the door seals damaged. Each microwave oven should carry a permanent notice to this effect. Microwave radiation checks should be carried out at regular intervals.

23.7 Catering equipment

23.7.1 Except under the supervision of a competent person, no one should use catering equipment unless trained in its use and fully instructed in the precautions to be observed.

23.7.2 Dangerous parts of catering machines should be properly guarded and the guards kept in position whenever the machine is used.

23.7.3 Any machine or piece of equipment should be inspected routinely for faults, wear and tear, damage or defective parts. Any machine or piece of equipment that is found to be damaged, faulty or defective in its parts, guards or safety devices should be reported and taken out of service, with power disconnected, until repaired.

Blank page

23.7.4 When a power-operated machine has to be cleaned or a blockage in it removed, it should be switched off and isolated from the power supply. Some machines will continue to run down for a while thereafter, and care should be taken to see that dangerous parts have come to rest before cleaning is begun.

23.7.5 A safe procedure for cleaning all machines should be established and carefully followed. Every precaution should be taken where cutting edges (e.g. on slicing machines) are exposed by the necessary removal of guards to allow thorough cleaning. Guards should be properly and securely replaced immediately the job is done.

23.7.6 Unless properly supervised, a seafarer under 18 years of age should not clean any power-operated or manually driven machine with dangerous parts that may move during the cleaning operation.

23.7.7 Appropriate kitchen tools, not fingers, should be used to feed materials into processing machines.

23.7.8 Electrical equipment should not be used with wet hands.

23.7.9 All electrical equipment should be regularly inspected by a competent person.

23.8 Knives, meat saws, choppers, etc.

23.8.1 Sharp implements should be treated with respect and handled with care at all times. They should not be left lying around working areas where someone may accidentally cut themselves. They should not be mixed in with other items for washing up but cleaned individually and stored in a safe place.

23.8.2 Knives should be kept tidily in secure racks or sheaths when not in use.

23.8.3 The handles of knives, meat saws, choppers, etc. should be securely fixed and kept clean and free from grease. The cutting edges should be kept clean and sharp.

23.8.4 Proper can openers in clean condition should be used to open cans; improvisations are dangerous and may leave jagged edges on the can.

23.8.5 Chopping meat requires undivided attention. The chopping block must be firm, the cutting area of the meat well on the block and hands and body clear of the line of strike. There must be adequate room for movement and no obstructions in the way of the cutting stroke. Particular care is required when the vessel is moving in a seaway. Appropriate gloves for use when cutting meat should also be supplied.

23.8.6 Foodstuffs being chopped with a knife should not be fed towards the blade with outstretched fingers. Fingertips on the free hand should be tucked in towards the palm of the hand with the thumb overlapped by the forefinger. The knife blade should be angled away from the work, with the knuckles as a guide so away from the fingers.

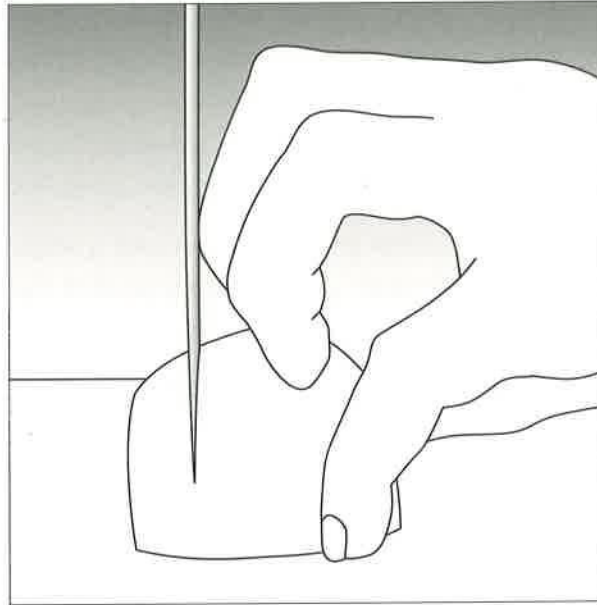

23.8.7 A falling knife should be left to fall, not grabbed.

23.8.8 A meat saw should be guided by the forefinger of the free hand over the top of the blade. The use of firm even strokes will allow the blade to feel its way; if forced, the saw may jump, possibly causing injury.

23.9 Refrigerated rooms and store rooms

23.9.1 All refrigerated room doors should be fitted with a means of opening the door from both sides. It should be possible to sound an alarm from inside the room.

23.9.2 A routine testing of the alarm bell and checking of the door clasps and inside release should be carried out regularly, at least at weekly intervals.

23.9.3 Those using the refrigerated room should make themselves familiar with the operation, in darkness, of the inside release for the door and the location of the alarm button.

23.9.4 All refrigerated room doors should be fitted with an arrangement of adequate strength to hold the door open in a seaway and should be secured open while stores are being handled. These doors are extremely heavy and can cause serious injury to a person caught between the door and the jamb.

23.9.5 Anyone going into a refrigerated room should take the padlock, if any, inside with them. Another person should be informed.

23.9.6 Cold stores or refrigerated rooms should not be entered if it is suspected that there has been a leakage of refrigerant. A warning notice to this effect should be posted outside the doors.

23.9.7 All stores and crates should be stowed securely so that they do not shift or move in a seaway.

23.9.8 When wooden boxes or crates are opened, protruding fastenings should be removed or made safe.

23.9.9 Metal meat hooks not in use should be stowed in a special container provided for the purpose. Where hooks cannot be removed easily, they should be kept away from passageways or areas where people are working.

23.9.10 For entry into meat and fish storage rooms, appropriate thermal personal protective equipment should be readily available.

Blank page

CHAPTER 24

HOT WORK

24.1 Introduction

24.1.1 Based on the findings of the risk assessment, appropriate control measures should be put in place to protect those who may be affected. This chapter identifies some areas that may require attention in respect of hot work.

24.2 General

24.2.1 Hot work in places other than the workshop should be the subject of a permit to work (see Chapter 14, Permit to work systems).

24.2.2 Operators should be suitably trained in the process, familiar with the equipment to be used and instructed where special precautions need to be taken.

24.2.3 Before welding, flame cutting, angle grinding or other hot work is started, a check should be made that there are no combustible solids, liquids or gases at, below or adjacent to the area of work that might be ignited by heat or sparks from the work. Such work should never be undertaken on surfaces covered with grease, oil or other flammable or combustible materials. Where necessary, combustible materials and dunnage should be moved to a safe distance before commencing operations. Such places should also be free of materials that could release a flammable substance if disturbed, for example.

24.2.4 When hot work is to be done in the vicinity of open hatches, suitable screens should be erected to prevent sparks dropping down hatchways or hold ventilators.

24.2.5 Port holes and other openings through which sparks may fall should be closed where practicable.

24.2.6 When work is being done close to or at bulkheads, decks or deckheads, the far side of the divisions should be checked for materials and substances that may ignite, and for cables, pipelines or other services that may be affected by the heat.

24.2.7 Cargo tanks, fuel tanks, cargo holds, pipelines, pumps and other spaces that have contained flammable substances should be certified as being free of flammable gases before any repair work is commenced. The testing should include, as appropriate, the testing of adjacent spaces, double bottoms and cofferdams. Further tests should be carried out at

regular intervals and before hot work is recommenced following any suspension of the work. When carrying out hot work on tankers and similar ships, all tanks, cargo pumps and pipelines should be thoroughly cleaned and particular care taken with the draining and cleaning of pipelines that cannot be directly flushed using the ship's pumps.

24.2.8 Where portable lights are needed to provide adequate illumination, they should be clamped or otherwise secured in position, not handheld, with leads kept clear of the working area.

24.2.9 Hot work should be properly supervised and kept under regular observation. Suitable fire extinguishers should be kept at hand ready for use during the operation. A person with a suitable extinguisher should also be stationed to keep watch on areas that may be affected that are not visible to the seafarer doing the work.

24.2.10 In view of the risk of delayed fires resulting from the use of burning or welding apparatus, frequent checks should be made for at least two hours after the work has stopped.

24.3 Welding and gas cutting

24.3.1 Harmful fumes can be produced from galvanising paint and other protective materials. Oxygen in the atmosphere can be depleted when using gas-cutting equipment and noxious gases may be produced when welding or cutting. Special care should therefore be taken to provide adequate ventilation when welding and flame cutting in enclosed spaces. The effectiveness of the ventilation should be checked at intervals while the work is in progress and, if appropriate, local exhaust ventilation should be considered. In dangerous spaces, breathing apparatus may be required.

24.3.2 Suggested procedures for lighting up and shutting down are in Annex 24.1.

24.4 Personal protective equipment

24.4.1 Personal protective equipment complying with the relevant standard specifications or their equivalent must be worn by the operator and as appropriate by those assisting with the operation to protect them from particles of hot metal and slag, and protect their eyes and skin from ultra-violet and heat radiation.

The operator should normally wear:

- welding shields or welding goggles with appropriate shade of filter lens to EN 169 (goggles are only recommended for gas welding and flame cutting);

- leather gauntlets;
- leather apron (in appropriate circumstances); and
- long-sleeved natural-fibre boiler suit or other approved protective clothing.

24.4.2 Clothing should be free of grease and oil and other flammable substances.

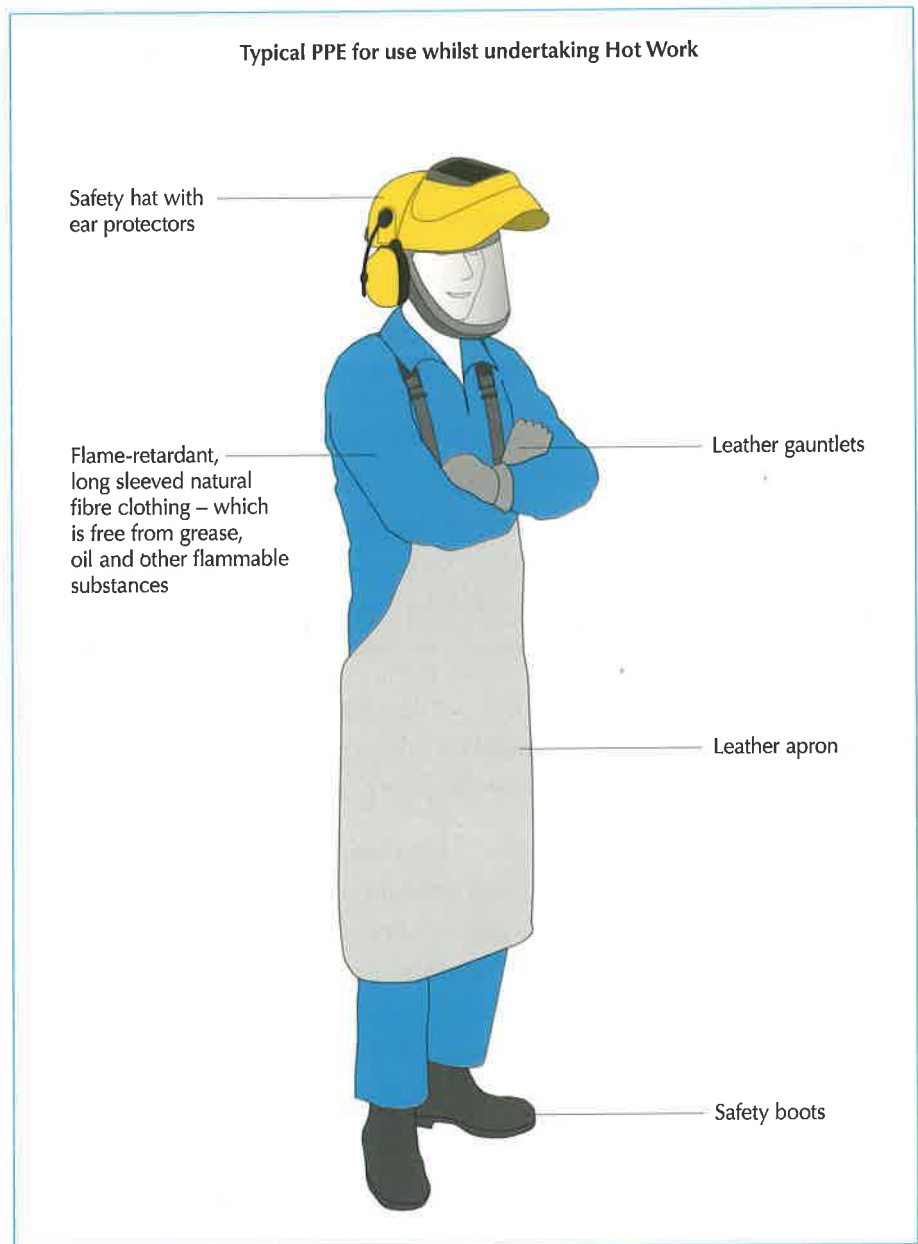

24.5 Pre-use equipment check

24.5.1 Hot work equipment should be inspected before use by a competent person to ensure that it is in a serviceable condition.

24.5.2 In cold weather, moisture trapped in the equipment may freeze and, for example, cause valves to malfunction. It is recommended that equipment is thawed out with hot water and cloths, never with naked flames.

24.6 Electric welding equipment

24.6.1 In order to minimise personal harm from electric shock, electric welding power sources for shipboard use should have a direct current (DC) output not exceeding 70V, with a minimum ripple. Further information on DC power sources is given in section 24.6.11.

24.6.2 When DC equipment is not available, AC output power sources may be used providing they have an integral voltage-limiting device to ensure that the idling voltage (the voltage between electrode and workpiece before an arc is struck between them) does not exceed 25 V rms. The proper function of the device (which may be affected by dust or humidity) should be checked each time a welding set is used. Some voltage-limiting devices are affected by their angle of tilt from the vertical, so it is important that they are mounted and used in the position specified by the manufacturers. This requirement can be affected by adverse sea conditions.

24.6.3 A 'go-and-return' system using two cables from the welding set should be adopted; the welding return cable should be firmly clamped to the workpiece.

24.6.4 Earthing of the workpiece is used to provide protection against internal insulation failure of the welding transformer, by keeping the workpiece at or near earth potential until the protective device (e.g. a fuse) operates to cut off the mains supply. Where the welding circuit is not adequately insulated from the earthed referenced mains supply (i.e. not constructed to one of the standards listed in Annex 24.2), the workpiece should be earthed. The 'return' cable of the welding set and each workpiece should be separately earthed to the ship's structure. The use of a single cable with hull return is not recommended. The workpiece earthing conductor should be robust enough to withstand possible mechanical damage and should be connected to the workpiece and a suitable earth terminal by bolted lugs or secure screw clamps.

Note: Some manufacturers may recommend earthing as one of their measures to reduce electrical interference. This is not a safety-related measure, but the manufacturer's advice should be followed.

EN 60529:1992 +
A2:2013

24.6.5 If an alternative method of protecting against welding transformer insulation failure is used, the hazards caused by stray welding currents can be avoided by not earthing the workpiece or the welding output circuit. Self-contained engine-driven welding sets, and welding power sources that comply with the standards listed in Annex 24.2, do not need the workpiece to be earthed. It should be noted, however, that other equipment connected to the workpiece may require earthing for safe operation (e.g. welding sets not constructed to one of the standards listed in Annex 24.2 or electrical pre-heating systems).

24.6.6 To avoid voltage drop in transmission, the lead and return cables should be of the minimum length practicable for the job and of an appropriate cross-section.

24.6.7 Cables should be inspected before use; if the insulation is impaired or conductivity reduced, they should not be used.

24.6.8 Cable connectors should be fully insulated when connected, and so designed and installed that current-carrying parts are adequately recessed when disconnected.

24.6.9 Electrode holders should be fully insulated so that no live part of the holder is exposed to touch and, where practicable, they should be fitted with guards to prevent accidental contact with live electrodes, and as protection from sparks and splashes of weld metal.

24.6.10 A local switching arrangement or other suitable means should be provided for rapidly cutting off current from the electrode should the operator get into difficulties, and also for isolating the holder when electrodes are changed.

24.6.11 The direct current output from power sources should not exceed 70 volts open circuit. The ripple on the output from the power source should not exceed the values of the table below. The ripple magnitudes are expressed as percentages of the DC, and the ripple peak is that with the same polarity as the DC.

Ripple frequency, Hz	50/60	300	1200	2400
Max. rms O/C voltage ripple, (%)	5	6	8	10
Max. peak O/C voltage ripple, (%)	10	12	16	20

24.6.12 The conditions in the table in section 24.6.11 are normally met by DC generators incorporating commutators and by rectifier power sources having a three-phase bridge rectifier operating from a three-phase 50/60 Hz supply. Rectifier power sources should not be operated from a power supply of less than 50 Hz.

24.6.13 Should it be necessary to use a power source with a DC output having a ripple magnitude in excess of those stated in the table (e.g. a single-phase rectifier power source), then a voltage-limiting device should be incorporated in the power source to ensure that the idling voltage does not exceed 42V.

24.7 Precautions to be taken during electric arc welding

24.7.1 In addition to the protective clothing specified in section 24.4.1, the welding operator should wear non-conducting safety footwear complying with BS 7193:1989. Clothing should be kept as dry as possible as some protection against electric shock; it is particularly important that gloves should be dry because wet leather is a good conductor.

24.7.2 An assistant should be in continuous attendance during welding operations and they should be alert to the risk of accidental shock to the welder and ready to cut off power instantly, raise the alarm and provide artificial respiration without delay. It may be desirable to have a second assistant if the work is to be carried out in difficult conditions.

24.7.3 Where persons other than the operator are likely to be exposed to harmful radiation or sparks from electric arc welding, they should be protected by screens or other effective means.

24.7.4 In restricted spaces, where the operator may be in close contact with the ship's structure or is likely to make contact in the course of ordinary movements, protection should be provided by dry insulating mats or boards.

24.7.5 There are increased risks of electric shock to the operator if welding is done in hot or humid conditions; body sweat and damp clothing greatly reduce body resistance. Under such conditions, the operation should be deferred until such time that an adequate level of safety can be achieved.

24.7.6 In no circumstances should a welder work while standing in water or with any part of their body immersed.

24.7.7 The electrode holder should be isolated from the current supply before a used electrode is removed and before a new electrode is inserted. This precaution is necessary because some electrode coatings have extremely low resistance. Even a flux coating, which is normally insulating, can become damp from sweating hands and thus potentially dangerous.

24.7.8 When the welding operation is completed or temporarily suspended, the electrode should be removed from the holder.

24.7.9 Hot electrode ends should be ejected into a suitable container; they should not be handled with bare hands.

24.7.10 Spare electrodes should be kept dry in their container until required for use.

24.8 Compressed gas cylinders

24.8.1 Compressed gas cylinders should always be handled with care, whether full or empty. They should be properly secured and stored in a location appropriate to their intended use and risks, which an inadvertent release of gas may present. The cylinders should be so secured as to be capable of quick and easy release, e.g. in the case of fire. Where appropriate, cylinder trolleys should be used to transport cylinders from one place to another.

24.8.2 If the cylinder design permits protective caps over the valve, such caps should be screwed in place when the cylinders are not in use or are being moved. Where the cylinder design does not permit protective caps over the valve, the valve system should be protected from inadvertent damage, e.g. from impact. Valves should be closed when cylinders are empty.

24.8.3 Care should be taken in the storage of flammable gases used for hot work. The storage should:

- be separated according to type of gas, and empty cylinders kept separate from full ones;
- be well ventilated;
- not be subject to extremes of temperatures;
- not contain any sources of ignition, including electronic devices; and
- be prominently marked 'No smoking' and have safety signs in accordance with the standards in Chapter 9, Safety signs and their use, Annex 9.1.

24.8.4 The following precautions also need to be taken in the case of compressed gas cylinders:

- Cylinders' valves, controls and associated fittings should be kept free from oil, grease and paint; controls should not be operated with oily hands.
- Gas should not be taken from such cylinders unless the correct pressure-reducing regulator has been attached to the cylinder outlet valve.

- Cylinders found to have leaks that cannot be stopped by closing the outlet valve should be taken to the open deck away from any sources of heat or ignition and slowly discharged to the atmosphere.

24.8.5 Identifying marks on cylinders are set out in section 9.7.

24.9 Gas welding and cutting

24.9.1 While this section deals almost exclusively with oxygen and acetylene, other fuel gases may be used and similar precautions should be taken.

24.9.2 The pressure of oxygen used for welding should always be high enough to prevent acetylene flowing back into the oxygen line.

24.9.3 Acetylene should not be used for welding at a pressure exceeding 1 atmosphere gauge because it is liable to explode when under excessive pressure, even in the absence of air.

24.9.4 Non-return valves should be fitted adjacent to the torch in the oxygen and acetylene supply lines.

24.9.5 Flame arrestors should be provided in the oxygen and acetylene supply lines and will usually be fitted at the low-pressure side of regulators, although they may be duplicated at the torch.

24.9.6 Should a backfire occur (i.e. the flame returns into the blowpipe and continues burning in the neck or mixing chamber), the recommended first action is to close the oxygen valve on the blowpipe – to prevent internal burning – followed immediately by shutting off the fuel gas at the blowpipe valve. Items 3–6 of the shutting-down procedure in Annex 24.1 may then be followed. When the cause of the backfire has been discovered, the fault rectified and the blowpipe cooled down, the blowpipe may be re-lit.

24.9.7 If there is a flashback into the hose and equipment, or a hose fire or explosion, or a fire at the regulator connections or gas supply outlet points, the first action should be to isolate the oxygen and fuel gas supplies at the cylinder valves or gas supply outlet points – but only if this can be done safely. Further action should follow in accordance with the vessel's fire-drill requirements.

24.9.8 A watch should be kept on acetylene cylinders to ensure that they are not becoming hot. If they are, this could be a sign of acetylene decomposition and there is an increased risk of explosion. The cylinder stop valve should be closed immediately, which may limit or reduce the decomposition but is unlikely to stop it. Emergency action, such as evacuating the area and prolonged cooling by immersion or with copious

amounts of water, will still be required. Consideration should be given to jettisoning the cylinder overboard, although movement of the cylinder can promote rapid decomposition, and cooling should continue while it is being moved. Any acetylene cylinder suspected of overheating should be approached with extreme caution because an impact could set off an internal ignition, which might cause an explosion.

24.9.9 Only acetylene cylinders of approximately equal pressures should be coupled.

24.9.10 In fixed installations, manifolds should be clearly marked with the gas they contain.

24.9.11 Manifold hose connections, including inlet and outlet connections, should be such that the hose cannot be interchanged between fuel gases and oxygen manifolds and headers.

24.9.12 Only those hoses specially designed for welding and cutting operations should be used to connect any oxy-acetylene blowpipe to gas outlets.

24.9.13 Any length of hose in which a flashback has occurred should be discarded.

EN 1256:2006

24.9.14 The connections between hose and blowpipe and between hoses should be securely fixed with fittings that comply with Standard EN 1256. (More detailed guidance on hose connections and assemblies can be found in Annex 24.3.)

24.9.15 Hoses should be arranged so that they are not likely to become kinked, tangled, tripped over, cut or otherwise damaged by moving objects or falling metal slag, sparks, etc. A sudden jerk or pull on a hose is liable to pull the blowpipe out of the operator's hands, or cause a cylinder to fall or a hose connection to fail. Hoses in passageways should be covered to avoid them becoming a tripping hazard.

24.9.16 Soapy water should only be used for testing leaks in hoses. If there are leaks that cannot easily be stopped, the gas supply should be isolated and the leaking components taken out of service, replaced or repaired. If the leak is at a cylinder valve or pressure regulator ('bull-nose') connection, the cylinder should be removed to a safe place in the open air. If it is a fuel-gas cylinder, it should be taken well clear of any source of ignition.

24.9.17 Excessive force should never be used on cylinder valve spindles or hexagon nuts of regulator connections in an attempt to stop a leak. Sealing tape and other jointing materials are not recommended for use in an attempt to prevent leaks between metal-metal surfaces that are

designed to be gas tight. With an oxygen cylinder, this could result in initiation of a metal–oxygen fire.

24.9.18 Blowpipes should be lit with a special friction igniter, stationary pilot flame or other safe means.

24.9.19 Should a blowpipe-tip opening become clogged, it should be cleaned only with the tools especially designed for that purpose.

24.9.20 When a blowpipe is to be changed, the gases should be shut off at the pressure-reducing regulators.

24.9.21 To prevent a build-up of dangerous concentrations of gas or fumes during a temporary stoppage or after completion of the work, supply valves on gas cylinders and gas mains should be securely closed and blowpipes, hoses and moveable pipes should be removed to lockers that open onto the open deck.

24.9.22 Oxygen should never be used to ventilate, cool or blow dust off clothing.

24.10 Further information

24.10.1 Detailed advice on the selection and standards for equipment used in hot work is contained in the Health and Safety Executive (HSE) guidance note, 'HSG139 The safe use of compressed gases in welding, flame cutting and allied processes', which can be found on the HSE website.

Annex 24.1 Hot work: lighting up and shutting down procedures

These procedures are appropriate for oxy-fuel gas equipment and, with little modification, also for air-aspirated blowpipes.

Pre-lighting up

1. Complete risk assessment including survey of all adjacent spaces and obtain hot-work permit to work.
2. Fire sentries to be posted in all adjacent compartments.

Lighting up

1. Ensure that the pre-use equipment checks have been made.
2. Check that the outlets of adjustable pressure regulators are closed, i.e. that the pressure-adjusting screw of the regulator is in the fully unwound (anti-clockwise) position.
3. Check that the blowpipe valves are closed.
4. Slowly open the cylinder valves (or gas supply point isolation valves) to avoid sudden pressurisation of any equipment.
5. Adjust pressure regulators to the correct outlet pressures, or check that the pressures in distribution pipework are suitable for the equipment and process.
6. Open the oxygen valve at the blowpipe and allow the flow of oxygen to purge* air out of the oxygen hose and equipment. If necessary, reset the pressure regulator to ensure the correct working oxygen pressure.
7. Close the oxygen valve at the blowpipe.
8. Open the fuel gas valve at the blowpipe and allow the gas flow to purge* air or oxygen from the fuel gas hose and equipment. If necessary, reset the pressure regulator to ensure the correct working fuel gas pressure.
9. Light the fuel gas immediately, and preferably with a spark lighter.
10. Open the oxygen valve at the blowpipe and adjust it and the fuel gas valve to give the correct flame setting.

* Purging is important. It removes flammable gas mixtures from the hoses and equipment, which could result in explosions and fires when the blowpipe is first lit. It should be carried out in a well-ventilated area, and it may take from several seconds to a minute or more depending on the length of the hose and gas flow rates.

Shutting down

1. Close the fuel gas valve at the blowpipe.
2. Immediately close the oxygen valve at the blowpipe.
3. Close the cylinder valves or gas supply point isolation valves for both oxygen and fuel gas.**
4. Open both blowpipe valves to vent the pressure in the equipment.
5. Close the outlets of adjustable pressure regulators by winding out the pressure-adjusting screws.
6. Close the blowpipe valves.

** Step 3 is not necessary when the equipment is to be used again in the immediate future.

On completion of hot work and following shutdown, all adjacent compartments should be visited to ensure that all is well.

Annex 24.2 Earthing of arc-welding systems' transformer casing

Earthed	Class I appliance
Not earthed	Class II appliance

Transformer secondary

Earthed

This is an obsolete type of equipment and should be taken out of service. Failure of the weld-return connection might not be noticed, and damage to other earthed metallic paths could result.

Isolated

The absence of a weld-return conductor will prevent welding being carried out. However, a failure of isolation within the welding set could cause the work item to become live. For this reason, the workpiece should be earthed.

Isolated with double or reinforced insulation

This is the most recent standard to which equipment is being built. Owing to the strengthened insulation, the workpiece need not be earthed. Furthermore, to prevent the possibility of stray weld-return currents in the supply system earth conductors, it is recommended that the workpiece is not earthed. Such welding power sources may be identified by the additional symbol if made to the relevant parts of BS EN 60974-1:2012 and complying with the requirements of British Standard Code of Practice 7418:1991, or they will be marked with the standards numbers EN 50.060, EN 60.974 or IEC974.

BS EN 60974-1:2012

Annex 24.3 Hot work: hoses and connections/ assemblies

Hoses

*BS EN ISO
3821:2010*

Rubber hoses complying with Standard BS EN ISO 3821:2010 are recommended for use in gas-welding and cutting processes, which are often carried out in aggressive working environments. Hoses satisfying these standards are reinforced with an outer protective cover designed to be resistant to hot surfaces, molten slag or sparks, and made with linings that resist the action of hydrocarbons (for liquefied petroleum gas (LPG) hose), acetone or dimethyl formamide (for acetylene hoses) and ignition in an atmosphere of oxygen (for all services). Burst pressure is 60 bar g and maximum working pressure 20 bar g.

BS 3212:1991

Hose made of thermoplastics materials is not generally suitable for welding and cutting, because it does not have the same resistance to hot surfaces or hot particles as reinforced rubber hose.

Connections

EN 1256:2006

Hose connections (comprising hose nipples and 'bull-nose' hose connections) comply with EN 1256, ISO/TR 28821:2012 or equivalent. Thread sizes specified in these standards are based on Whitworth dimensions, which are generally used in this field in many countries. Right-hand threads are used for oxygen and non-combustible gases; left-hand threads are used for fuel gases, with the hexagon nuts on their union connections notched to aid identification.

Hose connections may also be made with a quick-action coupling – a male probe fitted to the end of the hose and a female connector with a self-sealing valve usually fitted to a fixed piece of equipment or gas supply outlet point. The probe is pushed into the female fitting where it locks in position and automatically opens the internal valve. Connections of this type are simple and quick to operate, and there is no need to use a spanner to tighten any nuts.

BS EN 561:2002

Problems are that the male probe may become damaged (e.g. from being dragged along the ground or overuse) and cause the coupling to leak, and there is a possibility of connecting the hose to the wrong gas outlet. Both should be avoided if couplings comply with Standard EN 561 or ISO 7289:2010. These require hard material of construction to be used for the probes, and their design dimensions are intended to prevent interchangeability between oxygen and fuel gas connections.

Hose assemblies

Hose lengths are usually supplied in the UK as pre-assembled units complete with connection fittings crimped to the ends of the hose. Hose and hose-nipple dimensions are matched by the supplier to ensure a good fit. The recommended standard for hose assemblies is EN 1256, which specifies requirements for leak tightness and resistance to axial loading. Worm drive or similar clips are not recommended for fastening hoses.

Blank page

CHAPTER 25

PAINTING

25.1 Introduction

25.1.1 Based on the findings of the risk assessment, appropriate control measures should be put in place to protect those who may be affected. This chapter identifies some areas that may require attention in respect of painting.

25.2 Preparation and precautions

25.2.1 Because the origin of any paint to be removed may be unknown, precautionary measures should be taken in all circumstances. Painted surfaces should always be rubbed down wet to reduce dust from the old paint, which may be toxic if inhaled. Where the dust is known to contain lead, other dust-treating methods should be used. Appropriate respiratory protective equipment should be worn as protection against other dusts.

25.2.2 If the surface to be rubbed down is known to contain lead, then methods that do not create dust should be adopted. It is safer to avoid or minimise dust creation than to try to clean up the dust afterwards. Sanding or abrasive blasting should be avoided. Lead-based paint should never be burnt off because fumes will contain metallic lead in a readily absorbed form.

25.2.3 Rust removers are acids and contact with unprotected skin should be avoided. Eye/face protection should be worn against splashes (see Chapter 8, Personal protective equipment). If painting aloft or otherwise near ropes, care should be taken to avoid splashes on ropes, safety harness, lines, etc. (see sections 18.33.2 and 18.33.3 on the effect of such contamination on ropes).

25.2.4 Interior and enclosed spaces should be well ventilated, both while painting is in progress and until the paint has dried.

25.2.5 There should be no smoking or use of naked lights during painting or until the paint has dried hard. Some vapours even in low concentrations may decompose into more harmful substances when passing through burning tobacco.

25.2.6 When painting is done in the vicinity of machinery, the power supply should be isolated and the machine immobilised in such a way that it cannot be moved or started up inadvertently. Appropriate warning notices should be posted. Close-fitting clothing should be worn.

25.3 Application of new paint

25.3.1 Paints may be considered hazardous substances and mixtures, and may present risks that require precautions to be taken. Packaging is required to be marked with warning signs, which will give the first indication of any risks. A risk assessment should be carried out using the safety data sheet provided with the product. Seafarers using such paints should be warned of the particular risks arising from their use.

25.4 Use of paint-spraying equipment

25.4.1 Because there are many different types of paint-spraying equipment in use, seafarers should comply with the manufacturer's instructions for use.

25.4.2 Airless spray-painting equipment is particularly hazardous because the paint is ejected at a very high pressure and can penetrate the skin or cause serious eye injuries. Spray should not be allowed to come into contact with the face or unprotected skin.

25.4.3 Suitable protective clothing such as a combination suit, gloves, cloth hood and eye protection should be worn during spraying.

25.4.4 Paints containing lead, mercury or similarly toxic compounds should not be used.

25.4.5 A suitable respirator should be worn according to the nature of the paint being sprayed. In exceptional circumstances, it may be necessary to use specialist breathing apparatus (see section 8.8).

25.4.6 If a spray nozzle clogs, the trigger of the gun should be locked in a closed position before any attempt is made to clear the blockage.

25.4.7 Before a blocked spray nozzle is removed or any other dismantling is attempted, pressure should be relieved from the system.

25.4.8 When blowing through a reversible nozzle to remove a blockage, all parts of the body should be kept clear of the nozzle mouth.

25.4.9 The pressure in the system should not exceed the recommended working pressure of the hose. The system should be regularly inspected for defects.

25.4.10 As an additional precaution against the hazards of a hose bursting, a loose sleeve (e.g. a length of 2 to 3 metres (6 to 10 feet) of old air hose) may be slipped over that portion of the line adjacent to the gun and paint container.

Typical PPE for use whilst painting

(i) General painting:



Typical PPE for use whilst painting

(ii) Spray painting:

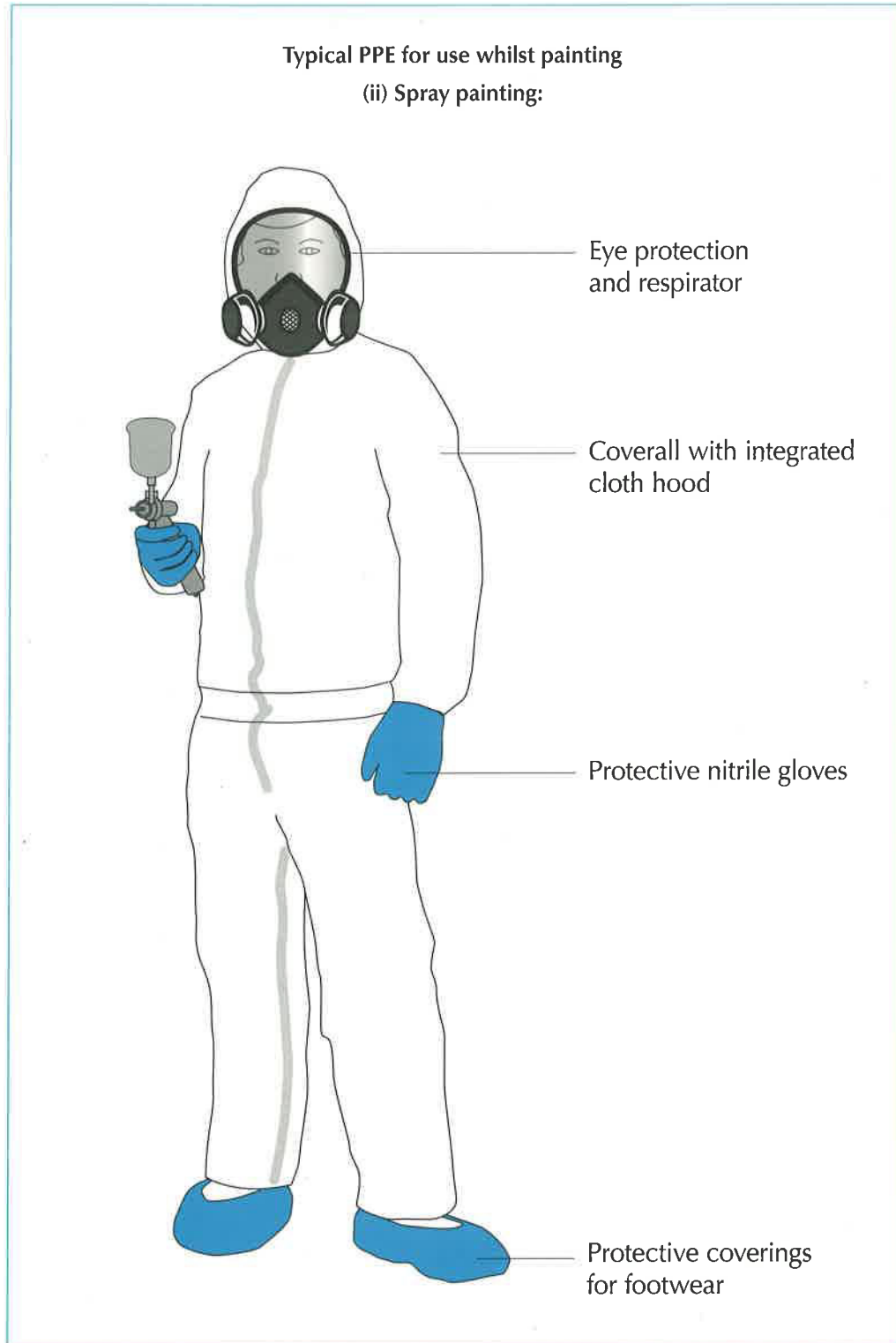

CHAPTER 26

ANCHORING, MOORING AND TOWING OPERATIONS

26.1 Introduction

26.1.1 All seafarers involved in anchoring, mooring and towing operations should be given additional instruction on the specific equipment and mooring configurations used on the vessel. This should include (but may not be limited to):

- the types of winches and windlass and their operation;
- the location of emergency stop buttons;
- the types of ropes and/or wires used; and
- the location and use of rollers, dollies and leads.

Records of instruction should be maintained.

26.1.2 Based on the risk assessment, appropriate control measures should be put in place. It is particularly important that the risk assessment considers the consequences of failure of any equipment. This chapter identifies some areas that require attention when anchoring, mooring or conducting towing operations. The risk assessment and control measures should be reviewed for each new mooring operation, taking account of the expected mooring configuration, with particular attention to potential risk of snap-back.

26.1.3 When anchoring, mooring or towing operations are taking place, all seafarers should be adequately briefed on the mooring configurations and correctly dressed in appropriate personal protective equipment.

26.2 Anchoring and weighing anchor

26.2.1 Before using an anchor, a competent seafarer must check that the brake is securely on and then clear all securing devices. A responsible person must be put in charge of the anchoring party, with a suitable means of communication with the vessel's bridge. The anchoring party should wear protective clothing, including safety helmet, safety shoes, gloves and goggles, to protect from injury by rust particles

and debris that may be thrown off the cable during the operation. Where the noise levels generated may be harmful, hearing protection may be considered; however, the time exposure and the greater risk from impaired communication should be taken into account. During anchoring, the anchoring party should stand aft of, or at a safe distance from, the windlass/capstan and be mindful of the potential risk of snap-back.

26.2.2 Where the means of communication between bridge and anchoring party is by portable radio, the identification of the ship should be clear to prevent confusion caused by other users on the same frequency.

26.2.3 Before the anchor is let go, a check must be made that there are no small craft or other obstacles under the bow. As a safety precaution, it is recommended that the anchor is 'walked out' clear of the pipe before letting go. For very large ships with heavy anchors and cables, the anchor should be either walked out at intervals or all the way to avoid excessive strain on the brakes (and on the bitter end, if the brakes fail to stop the anchor and cable).

26.2.4 When the anchor is let go from the stowed position, if, on release of the brake, the anchor does not run, seafarers should **not** attempt to shake the cable. The brake should be re-applied, the windlass placed in gear and the anchor walked out clear prior to release.

26.2.5 Cable should stow automatically. If, for any reason, it is necessary for seafarers to enter the cable locker, they must first take proper precautions for entering an enclosed space. They should stand in a protected position and be in communication with the windlass/capstan operator.

26.2.6 Anchors that are housed and not required should be properly secured to prevent accidental release.

26.3 Making fast and casting off

26.3.1 During mooring and unmooring operations, a sufficient number of seafarers should always be available both forward and aft of the vessel to ensure a safe operation. A responsible person should be in charge of each of the mooring parties, and a suitable means of communication between the responsible persons and the vessel's bridge team must be established. If this involves the use of portable radios, then the ship should be clearly identified by name to prevent confusion with other users. All seafarers involved in such operations must wear protective clothing, including safety helmet, safety shoes and gloves, and be fully briefed on the berthing plan.

26.3.2 Owing to the design of mooring decks, the entire area should be considered a potential snap-back zone. All crew working on a mooring deck should be made aware of this with clear visible signage.

26.3.3 The painting of snap-back zones on mooring decks should be avoided because they may give a false sense of security.

26.3.4 Working on enclosed mooring decks adds additional hazards and therefore extra caution should be exercised. Particular attention should be paid to ensure adequate lighting.

26.3.5 To prevent personal injury to those receiving heaving lines, the 'monkey's fist' should be made with rope only and must not contain added weighting material. Safe alternatives include a small high-visibility soft pouch, filled with fast-draining pea shingle or similar, with a weight of not more than 0.5 kg. Under no circumstances is a line to be weighted by items such as shackles, bolts or nuts, or twist locks.

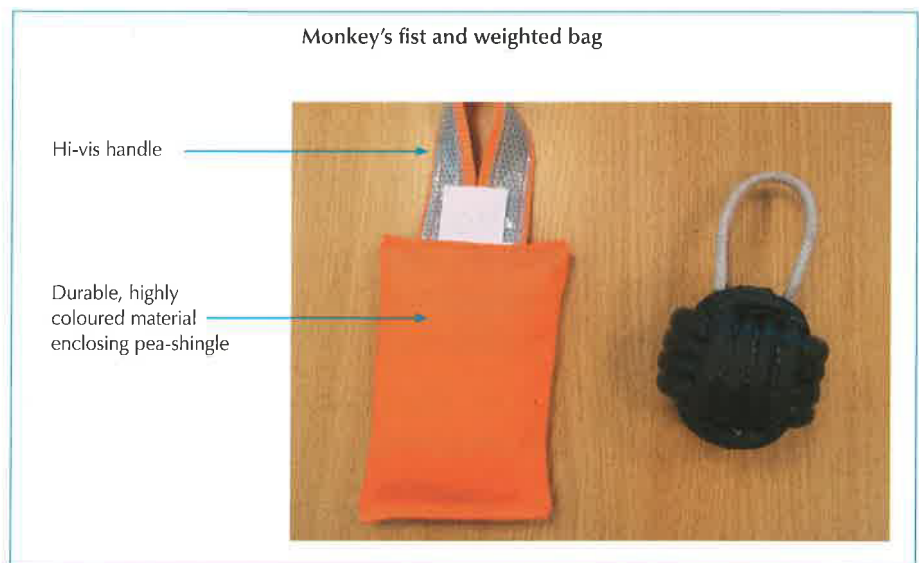

26.3.6 Areas where mooring operations are to be undertaken should be kept tidy and clutter free. All mooring ropes should be properly stowed, heaving lines and stoppers coiled away and any oil and grease cleaned up immediately. Decks should have anti-slip surfaces provided by fixed treads or anti-slip paint coating, and the whole working area should be adequately lit for operations undertaken during periods of darkness.

26.3.7 Equipment used in mooring operations should be regularly inspected for defects. Defects found should be corrected. Particular attention should be paid to oil leaks from winches. The surfaces of fairleads, bollards, bitts and drum ends should be clean and in good condition, and drum ends should not be painted. Rollers and fairleads should turn smoothly and a visual check be made that corrosion has not

weakened them. Pedestal roller fairleads, lead bollards, mooring bits, etc. should be:

- properly designed for the task;
- able to meet all foreseeable operational loads and conditions;
- correctly sited; and
- fixed to a part of the ship's structure that is suitably strengthened.

26.3.8 Mooring ropes, wires and stoppers are to be in good condition. Ropes should be inspected frequently for both external wear and wear between strands. Wires should be regularly treated with suitable lubricants and inspected for deterioration internally and broken strands externally. Lubricants should be thoroughly applied so as to prevent internal corrosion as well as corrosion on the outside, and wires should never be allowed to dry out. Splices in both ropes and wires should be inspected regularly to check that they are intact. Where wire rope is joined to fibre rope, a thimble or other device should be inserted in the eye of the fibre rope. Both wire and fibre rope should have the same direction of lay.

26.3.9 Ropes and wires that are stowed on reels should not be used directly from stowage, but should be run off and flaked out on deck in a clear and safe manner, ensuring sufficient slack to cover all contingencies. If there is doubt over the amount required, then the complete reel should be run off.

26.3.10 Ship's equipment can be employed to best effect if the following general principles are remembered:

- Breast lines provide the bulk of athwartships restraint.
- Springs provide the largest proportion of the longitudinal restraint.
- Very short lengths of line should be avoided when possible because such lines will take a greater proportion of the total load, when movement of the ship occurs.
- Very short lengths may be compensated for by running the line on the bight.

26.3.11 Careful thought should be given to the layout of moorings, so that the leads are those most suited without creating sharp angles, and ropes and wires are not fed through the same leads or bollards. Pre-planning of such operations is essential and a risk assessment of the operation must be completed, especially in cases where unusual or non-standard mooring arrangements are used.

26.3.12 Personnel should not, in any circumstances, stand in a bight of rope or wire. Operation of winches should be undertaken by competent seafarers to ensure that excessive loads do not arise on moorings.

26.3.13 When moorings lines are under strain, all personnel in the vicinity should remain in positions of safety, i.e. avoid the snap-back zones. It is strongly recommended that a bird's eye view of the mooring deck arrangement is produced to identify danger areas. Regardless of designated snap-back zones, seafarers should always be aware of other areas of potential danger – the whole mooring deck may be considered a danger zone.

26.3.14 Immediate action is to be taken to reduce the load should any part of the system appear to be under excessive strain. Care is needed to ensure that ropes or wires will not jam when they come under strain, so they can be slackened off quickly if necessary.

26.3.15 Where a mooring line is led around a pedestal roller fairlead, the snap-back zone area will change and increase in area. Where possible, lines should **not** be led round pedestals, except during the operation to moor the ship. Thereafter, lines should be made up on bitts, clear of pedestals if at all possible.

26.3.16 When moorings are to be heaved on a drum end, the winch operator must have a full view of all activity. The 'fleet angle' or lead angle of the rope onto the drum should be no more than a few degrees. One person should be stationed at the drum end, backed up by a second person, who is standing at least a metre away, backing and coiling down the slack. In most circumstances, three turns on the drum end are sufficient to undertake a successful operation and avoid riding turns. A wire on a drum end should never be used as a check wire. A synthetic rope should never be surged on the drum end. After being hauled tight, a stopper is to be used to allow the rope to be removed from the warping drum and then placed on a bollard or bitts by using either single turns or figures of eight. For wire rope, at least the top three lays of the figure of eight must be secured by a fibre rope to prevent jumping. The stopper material should be like for like (i.e. natural for natural, and chain for wire ropes).

26.3.17 A wire should never be led across a fibre rope on a bollard. Wires and ropes should be kept in separate fairleads or bollards.

26.3.18 When stoppering off moorings, the following applies:

- Natural fibre rope should be stoppered with natural fibre.
- Man-made fibre rope should be stoppered with man-made fibre stopper (but not polyamide).

- The 'West Country' method (double and reverse stoppering) is preferable for ropes.
- Wire moorings should be stoppered with chain, using two half-hitches in the form of a cow hitch, suitably spaced with the tail backed up against the lay of wire, to ensure that the chain neither jams nor opens up the lay of the wire.

26.4 Mooring to a buoy

26.4.1 Where mooring to a buoy is undertaken from a ship's launch or boat, seafarers engaged in the operation must wear a working lifejacket (personal flotation device). A lifebuoy with an attached lifeline should be available in the boat.

26.4.2 Means should be provided to recover a man overboard. If a boarding ladder with flexible sides is used, it should be weighted so that the lower rungs remain below the surface.

26.4.3 Where mooring to a buoy is undertaken from the ship, a lifebuoy with an attached line of sufficient length is to be available for immediate use.

26.4.4 When slip wires are used for mooring to buoys or dolphins, the eyes of the wires should never be put over the bitts, because at the time of unmooring it may not be possible to release the load sufficiently to lift the eye clear. To prevent accidental slippage of the wire eye(s) over the bitts or other obstruction, the eyes should be seized, partially closing the eye.

26.5 Towing

26.5.1 A number of accidents have occurred during the operation of making fast and releasing a tow. It is not uncommon for the gear to become taut without warning, causing the messenger to part and strike anyone in the snap-back zone, resulting in serious injury. Poorly controlled towing operations are also a significant hazard to tug crews.

26.5.2 Equipment used for towing should be adequately maintained and inspected before use because during towing operations, excessive loads may be applied to ropes, wires, fairleads, bitts and connections. If there are suspicions over the quality of the towline, it should be rejected and an alternative line used.

26.5.3 Prior to towing operations being undertaken, the master (and pilot) should establish a suitable means of communication, exchange relevant information (e.g. speed of vessel) and agree a plan for the tow with the tug master.

26.5.4 Seafarers involved must understand their duties and they should be adequately briefed on the operation and the safety precautions to be taken. They should be equipped with personal protective equipment including safety helmets, safety shoes and gloves. During hours of darkness, care should be taken to ensure that floodlighting will not dazzle and destroy the night vision of the tug master.

26.5.5 On instruction from the bridge, the heaving line should be thrown over to the tug from the shoulder (when taking a tow forward) of the vessel and not from the position of the Panama/Suez fairlead. The position in front of the vessel's (bulbous) bow is the most dangerous for the tug. The tug will then attach a messenger, which is placed on a winch and used to heave the tug's main towline on board. Only enough turns of the messenger should be used on the drum end to heave in the towline (see section 26.3.16). A stopper is then used while the eye is placed around the bollard. On tankers, the towline's eye should not be placed over the same bollard that the fire wire has made fast to. The fire wire should be taken off if there is no bollard available. The whole operation should be conducted efficiently to allow the tug to withdraw to a safe position without undue delay.

26.5.6 Once the tow is connected, seafarers should keep clear of the operational area. If anyone is required to remain in this area or to attend to towing gear during the towing operation, they should take extreme care to keep clear of bights of wire or rope and the snap-back zone at all times.

26.5.7 During operations, communications should be maintained between:

- the towing vessel and both the bridge team and the foredeck of the vessel under tow; and
- the tow party and the bridge team.

All parties should identify themselves clearly to avoid misunderstandings. The tug master should be kept informed of engine movements, proposed use of thrusters, etc. Seafarers in charge of the mooring party should monitor the towline to give warning to the crew if the towline should become taut, for whatever reason.

26.5.8 When letting go, no attempt should be made to heave in the messenger to release the tow before making positive communications with the tug. This should be done by the vessel's master or pilot and once the tug has indicated that it is ready to receive the tow back, the instruction to release must come from the vessel's master. The tug's messenger should be used to heave in the towline and then stopper it off before taking the eye off the bollard. Use turns of the messenger

around the bollard to control the speed at which the towline goes out and is retrieved on board the tug. This is particularly important aft where the towline, if it goes into the water, may foul the tug's propulsors. If the towline is allowed to run out uncontrolled, it could whiplash and strike a crew member, causing severe injuries. No attempt must be made to handle towlines that have weight on them.

MGN 308(M+F)

26.5.9 Further recommendations on towing are contained in the relevant merchant shipping notices (MSNs).

26.6 Safe mooring of domestic passenger craft and ships' launches to quays

26.6.1 The recognised and safe method for securing small vessels and launches alongside a quay or wharf in a good seafarer-like manner is by the use of all the following ropes:

- a fore spring;
- a back spring;
- a head rope; and
- a stern rope.

A risk assessment must be carried out for the full mooring arrangement and should include a diagram.

26.6.2 Annex 26.2 shows the full and safe mooring arrangement for small domestic passenger craft and ships' launches.

26.6.3 Reduced mooring arrangements may be used in exceptional circumstances. This may only be done after taking into account the weather and sea conditions, tidal state, tidal flow and respective snap-back zones. A risk assessment must be carried out for all arrangements that diverge from the full safe arrangement in section 26.6.1.

26.6.4 Passengers and seafarers should keep out of snap-back zones.

26.6.5 Where mid-ships mooring is the only means of making fast, breast lines may be run from mid-ships in addition to spring lines from the bow and stern.

26.6.6 Single-point mooring and steaming on a spring is not recommended and should be avoided.

Annex 26.1 Complex mooring system, illustrating the snap-back zone

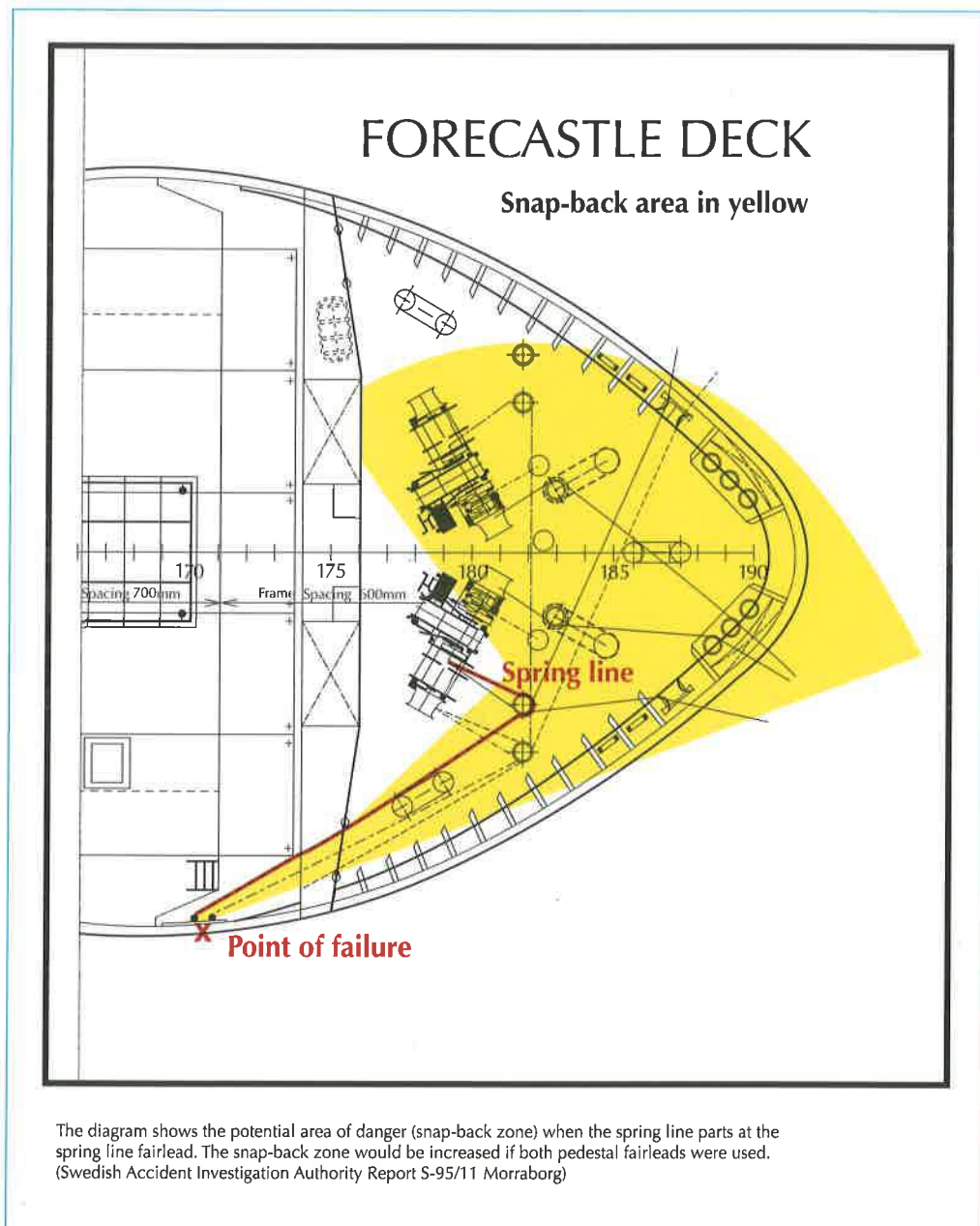

Blank page

Annex 26.2 The full and safe mooring arrangement for small, domestic passenger craft and launches

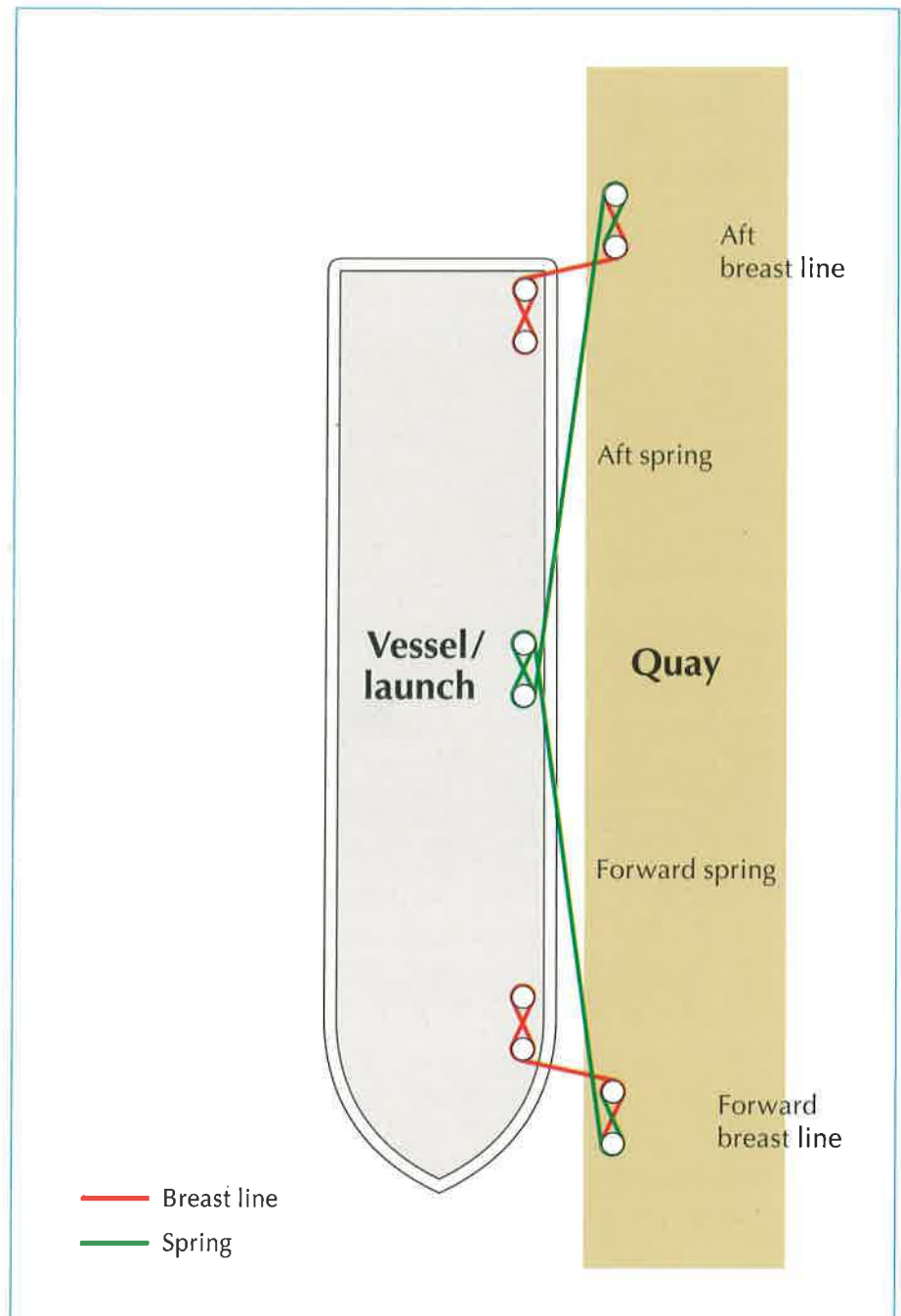

Blank page

CHAPTER 27

ROLL-ON/ROLL-OFF FERRIES

27.1 Introduction

27.1.1 This section gives general advice for the safety of personnel working on the vehicle decks of roll-on/roll-off (ro-ro) ferries. Where other documents or chapters of this Code apply, these are cross-referenced and should be read in conjunction with this chapter.

27.2 General

27.2.1 The movement, stowage and securing of vehicles on vehicle decks and ramps should be supervised by a responsible ship's officer, assisted by at least one competent person.

MGN 341(M)

27.2.2 Smoking and naked flames should not be permitted on any vehicle decks. Conspicuous 'no smoking' or 'no smoking/naked lights' signs should be displayed.

27.2.3 There should be no unauthorised persons on vehicle decks at any time, and there should be no entry to vehicle decks when the vessel is at sea, unless specifically permitted.

27.2.4 Passengers and drivers should not be permitted to remain on vehicle decks without the express authority of a responsible ship's officer. The period prior to disembarkation when passengers and drivers are requested to return to their vehicles should be kept to a minimum.

27.2.5 Where closed-circuit television (CCTV) cameras are fitted, they should, where practicable, have an uninterrupted view of the vehicle deck. The use of CCTV for continuous watch does not necessarily preclude the need for car-deck patrols, e.g. coupled with fire patrols of passenger accommodation.

27.3 Ventilation

*S.I. 1998/1011 and
S.I. 1998/1012*

27.3.1 Vehicle decks should have adequate ventilation at all times, with special regard to hazardous substances.

27.3.2 On passenger vessels, ventilation fans in closed ro-ro spaces must normally be run continuously whenever vehicles are on board. An increased number of air changes may be required when vehicles

are being loaded or unloaded, or where flammable gases or liquids are stowed in a closed ro-ro space. Merchant shipping regulations specify the special requirements for cargo space ventilation.

27.3.3 To reduce the accumulation of fumes, drivers should be instructed to stop their engines as soon as practicable after embarking and to avoid starting up prior to departure until instructed to do so. During loading and discharging, ventilation may be improved by keeping both bow and stern doors open, provided that there is adequate freeboard at these openings. When there is doubt about the freshness of the atmosphere, arrangements should be made for testing to ensure the maintenance of 20% oxygen and a carbon monoxide content below 30 ppm in the atmosphere of the space.

27.4 Fire safety/prevention

27.4.1 Fire-detection systems should be switched on whenever vehicle decks are unattended. Deck and engine crew should be trained in the use of the drencher systems and their operation. Continuous monitoring of vehicle decks by CCTV or regular fire patrols should also be in place.

27.4.2 All fire doors should be kept closed on vehicle decks when the vessel is at sea.

27.5 Noise

27.5.1 Personnel working on vehicle decks should not be exposed to the equivalent of 85 dB(A) or greater when averaged over an eight-hour day. Hearing protection should be available for use when the noise level is equivalent to or exceeds 80 dB(A) averaged over an eight-hour day, and should be worn when it is equivalent to or exceeds 85 dB(A) averaged over an eight-hour day. For further guidance on noise levels, see Chapter 12, Noise, vibration and other physical agents, of this Code and the *Code of Practice for Controlling Risks due to Noise on Ships* (revised 2009).

27.6 Safe movement

27.6.1 Pedestrians should be warned of vehicle movements when entering or crossing car or vehicle decks and keep to walkways when moving about the ship.

27.6.2 As far as possible, routes used by vehicles should be separated from pedestrian passageways, and the use of ship's ramps for pedestrian access should be avoided. Ramps that are used by vehicles should not be used for pedestrian access unless there is suitable segregation of vehicles and pedestrians. Segregation can be achieved through the provision of a

suitably protected walkway, or by ensuring that pedestrians and vehicles do not use the ramp at the same time (see the *Code of Practice on the Stowage and Securing of Vehicles on Roll-on/Roll-off Ships*, section 2.6).

27.6.3 Crew members should exercise great care when supervising the driving, marshalling and stowing of vehicles to ensure that no person is put at risk. The following precautions should be taken:

- Crew should be easily identifiable by passengers. Personnel required to be on the vehicle decks should wear appropriate personal protective equipment, including high-visibility clothing.
- Communications between deck officers and ratings should be clear and concise to maintain the safety of passengers and vehicles.
- There should be suitable traffic-control arrangements, including speed limits and, where appropriate, the use of signallers. Collaboration may be necessary with shore-side management where they also control vehicle movements on board ship.
- Hand signals used by loading supervisors and personnel directing vehicles should be unambiguous.
- Adequate illumination should be provided.
- Personnel directing vehicles should keep out of the way of moving vehicles, particularly those that are reversing, by standing to the side, and where possible should remain within the driver's line of sight. Extra care should be taken at the 'ends' of the deck where vehicles may converge from both sides of the ship.
- Crew members should be wary that vehicles may lose control on ramps and sloping decks, especially when wet, and that vehicles on ramps with steep inclines may be susceptible to damage. Ramps should have a suitable slip-resistant surface.
- Where fitted, audible alarms should be sounded by vehicles that are reversing.
- Safe systems of work should be provided in order to ensure that all vehicle movements are directed by a competent person.

27.7 Use of work equipment

27.7.1 Ships' ramps, car platforms, retractable car decks and similar equipment should be operated only by competent persons authorised by a responsible ship's officer, in accordance with the Company's work instructions. Safe systems of work should be provided to ensure that the health and safety of crew or passengers is not put at risk. Ramps, etc. should not be operated unless the deck and ramp can be seen to be clear of people and if any person appears on the deck while the ramp is

moving, the operation should be stopped immediately. Where possible, such ramps and decks should be fitted with audio and visual alarms.

27.7.2 Training in the use of such equipment should consist of theoretical instruction enabling the trainee to appreciate the factors affecting the safe operation of the plant, and supervised practical work.

27.7.3 Moveable deck ramps should be kept clear of passengers when being raised or lowered. When cars are lowered on the ramps of moveable decks, they should be suitably chocked. If the operator cannot clearly see the whole operation from the control station, then a lookout should be posted to ensure ramp and landing areas remain clear throughout the operation.

27.7.4 No person should be lifted by ramps, retractable car decks or lifting appliances, except where the equipment has been designed or especially adapted for that purpose.

27.7.5 Retractable car decks and lifting appliances should be securely locked when in the stowed position.

27.7.6 After all vehicles have been loaded, the car-deck hydraulics should be isolated so that they cannot be accidentally activated during the voyage, and the bridge should be informed.

27.7.7 The ship's mobile handling equipment, which is not fixed to the ship, should be secured in its stowage position before the ship proceeds to sea.

27.8 Inspection of vehicles

27.8.1 Before being accepted for shipment, every freight vehicle should be inspected externally by a competent and responsible person or persons to check that it is in a satisfactory condition for shipment, for example:

- it is suitable for securing to the ship in accordance with the approved cargo-securing manual (see also section 28.1.4);
- where practicable, the load is secured to the vehicle;
- the deck or doorway is high enough for vehicles to pass through and vehicles have adequate clearance for ramps with steep inclines; and
- any labels, placards and marks that would indicate the carriage of dangerous goods are properly displayed.

27.8.2 It is important to ensure, so far as is reasonably practicable, that on each vehicle the fuel tank is not so full as to create a possibility of spillage. No vehicle showing visual signs of an overfilled tank should be loaded.

27.8.3 Seafarers should be aware of hazardous units as detailed on the stowage plan and indicated by labels, placards and marks, and should be on guard against the carriage of undeclared dangerous goods.

27.9 Stowage

27.9.1 Shippers' special advice or guidelines regarding handling and stowage of individual vehicles should be observed.

27.9.2 Vehicles should:

- so far as possible, be aligned in a fore and aft direction;
- be closely stowed athwartships so that, in the event of any failure in the securing arrangements or from any other cause, the transverse movement is restricted. However, sufficient distance should be provided between vehicles to permit safe access for the crew and for passengers getting into and out of vehicles, and going to and from accesses serving vehicle spaces; and
- be so loaded that there are no excessive lists or trims likely to cause damage to the vessel or shore structures.

27.9.3 Vehicles should not:

- be parked on permanent walkways;
- be parked so as to obstruct the operating controls of bow and stern doors, entrances to accommodation spaces, ladders, stairways, companionways or access hatches, firefighting equipment, controls to deck scupper valves or controls to fire dampers in ventilation trunks; or
- be stowed across water spray fire curtains, if these are installed.

27.9.4 Safe means of access to securing arrangements, safety equipment and operational controls should be properly maintained. Stairways and escape routes from spaces below the vehicle deck should be clearly marked with yellow paint and kept free from obstruction at all times.

27.9.5 The parking brakes of each vehicle or each element of a vehicle, where provided, should be applied and the vehicle should, where possible, be left in gear.

27.9.6 Semi-trailers should not be supported on their landing legs during sea transport unless the landing legs are specially designed for that purpose and so marked, and the deck plating has adequate strength for the point loadings.

27.9.7 Uncoupled semi-trailers should be supported by trestles or similar devices placed in the immediate area of the drawplates so that the connection of the fifth-wheel to the kingpin is not restricted.

27.9.8 Drums, canisters and similar thin-walled packaging are susceptible to damage if vehicles break adrift in adverse weather, and should not be stowed on the vehicle deck without adequate protection.

27.9.9 Depending on the area of operation, the predominant weather conditions and the characteristics of the ship, freight vehicles should be stowed so that the chassis are kept as static as possible by not allowing free play in the suspension. This can be done by securing the vehicles to the deck as tightly as the lashing tensioning device will permit. Care should be taken to ensure lashings are not over-tightened. Only designed tensioning arrangements should be used and no additional extensions should be used to increase tightening force. Alternatively, the freight vehicle chassis may be jacked up prior to securing.

27.9.10 Because compressed air suspension systems may lose air, adequate arrangements should be made to prevent the slackening off of lashings as a result of air leakage during the voyage. Such arrangements may include the jacking up of a vehicle or the release of air from the suspension system where this facility is provided.

27.10 Securing of cargo

27.10.1 Securing operations should be completed before the ship proceeds to sea.

27.10.2 Within the constraints laid down in the approved cargo-securing manual, the master has the authority to decide on the application of securings and lashings and the suitability of the vehicles to be carried. In making this decision, due regard shall be given to the principles of good seamanship, experience in stowage, good practice and the International Maritime Organization (IMO) Code for Cargo Stowage and Securing (CSS Code).

27.10.3 Seafarers appointed to carry out the task of securing vehicles should be trained in the use of the equipment to be used and in the most effective methods for securing different types of vehicles.

27.10.4 Securing operations should be supervised by competent persons who are conversant with the contents of the cargo-securing manual. Freight vehicles of more than 3.5 tonnes should be secured in all circumstances where the expected conditions for the intended voyage are such that movement of the vehicles relative to the ship could be expected.

27.10.5 During the voyage, the lashings should be regularly inspected to ensure that vehicles remain safely secured. Seafarers inspecting vehicle spaces during a voyage should exercise caution in order to avoid being injured by moving or swaying vehicles. If necessary, the ship's course should be altered to reduce movement or dangerous sway when lashings are being adjusted. The officer of the watch should always be notified when an inspection of the vehicle deck is being made.

27.10.6 When wheel chocks are being used to restrain a semi-trailer, they should remain in place until the semi-trailer is properly secured to the semi-trailer towing vehicle.

27.10.7 No attempt should be made to secure a vehicle until it is parked, the brakes (where applicable) have been applied and the engine has been switched off.

27.10.8 When vehicles are being stowed on an inclined deck, the wheels should be chocked before lashing commences.

- The tug driver should not leave the cab to disconnect or connect the trailer brake lines. A second person should do this.
- The parking brake on the tug should be engaged and in good working condition.
- As well as wheel chocks, at least two lashings holding the unit against the incline should be left in place until the trailer's braking system is charged and operating correctly.

27.10.9 Where seafarers are working in shadow areas or have to go under vehicles to secure lashings, hand lamps and torches should be available for use.

27.10.10 Seafarers engaged in the securing of vehicles should take care to avoid injury from projections on the underside of the vehicles. An agreed method of signalling between the driver and the lashing crew should be established, preferably by the use of a whistle or other distinct sound signal.

27.10.11 Wherever possible, lashings should be attached to specially designed securing points on vehicles, and only one lashing should be attached to any one aperture, loop or lashing ring at each securing point.

27.10.12 When tightening lashings, care should be exercised to ensure that they are securely attached to the deck and to the securing points of the vehicle.

27.10.13 Hooks and other devices that are used for attaching a lashing to a securing point should be applied in a manner that prevents them from becoming detached if the lashing slackens during the voyage.

27.10.14 Lashings should be so attached that, provided there is safe access, it is possible to tighten them if they become slack.

27.10.15 Lashings on a vehicle should be under equal tension.

27.10.16 Where practicable, the arrangement of lashings on both sides of a vehicle should be the same, and angled to provide some fore and aft restraint, with an equal number pulling forward as are pulling aft.

27.10.17 The lashings are most effective on a vehicle when they make an angle with the deck of between 30° and 60°. When these optimum angles cannot be achieved, additional lashings may be required.

27.10.18 Where practicable, crossed lashings should not be used for securing freight vehicles because this arrangement provides no restraint against tipping over at moderate angles of roll of the ship. Lashings should pass from a securing point on the vehicle to a deck-securing point adjacent to the same side of the vehicle. Where there is concern about the possibility of low coefficients of friction on vehicles such as solid-wheeled trailers, additional crossed lashings may be used to restrain sliding. The use of rubber mats should be considered.

27.10.19 Lashings should not be released for unloading, before the ship is secured at the berth, without the master's express permission.

27.10.20 Seafarers should release lashings with care to reduce the risk of injury when the tension is released.

27.10.21 To avoid damage during loading and unloading, all unused securing equipment should be kept clear of moving vehicles on the vehicle deck.

27.10.22 A competent person should inspect securing equipment to ensure that it is in sound condition at least once every six months and on any occasion when it is suspected that lashings have experienced loads above those predicted for the voyage. Defective equipment should be taken out of service immediately and disposed of or placed where it cannot be used inadvertently. Unused lashing equipment should be securely stowed away from the vehicle deck.

27.11 Dangerous goods

27.11.1 This section should be read in conjunction with Chapter 21, Hazardous substances and mixtures. For guidance on dealing with emergencies involving dangerous goods, see Chapter 4, Emergency drills and procedures, and the International Maritime Dangerous Goods (IMDG) Code.

27.11.2 Prior to loading, freight vehicles carrying dangerous goods should be examined externally for damage and signs of leakage or shifting of contents. Any freight vehicle found to be damaged, leaking or with shifting contents should not be accepted for shipment. If a freight vehicle is found to be leaking after loading, a ship's officer should be informed and personnel kept well clear until it is ascertained that no danger to personnel persists.

27.11.3 Freight vehicles carrying dangerous goods and adjacent vehicles should always be secured.

MGN 59(M)

27.11.4 Tank vehicles and tank containers on flat-bed trailers containing products declared as dangerous goods should be given special attention. (For heated tanks, see marine guidance note *MGN 59(M)*.) Pre-voyage booking procedures should ascertain that tanks have been approved for the carriage of their contents by sea.

MGN 341(M)
MGN 545(M+F)
MGN 552(M)

27.12 Specialised vehicles

27.12.1 Gas cylinders used for the operation and business of vehicles such as caravans should be adequately secured against movement of the ship, with the gas supply cut off for the duration of the voyage. Leaking and inadequately secured or connected cylinders should be refused for shipment.

27.12.2 The following vehicles, trailers and loads should be given special consideration:

- Tank vehicles or tank containers containing liquids not classified as dangerous goods. These may be sensitive to penetration damage and may act as a lubricant. These vehicles must always be secured.
- Tracked vehicles and other loads making metal-to-metal contact with the deck; where possible, rubber mats or dunnage should be used.
- Loads on flat-bed trailers.
- Vehicles with hanging loads, such as chilled meat or floated glass.
- Partially filled tank vehicles.

27.12.3 Freight vehicles carrying livestock require special attention to ensure that they are properly secured, adequately ventilated and stowed so that access to the animals is possible. Further guidance is contained in the Department of the Environment, Food and Rural Affairs (Defra) regulation on the *Welfare of Animals During Transport: New rules for transporting animals* (see Appendix 2, Other sources of information).

27.12.4 Where vehicles are connected to electrical plug-in facilities, personnel should take the appropriate precautions as described in Chapter 18, Provision, care and use of work equipment, of this Code for working with any electrical equipment.

27.13 Housekeeping

27.13.1 All walkways should be kept clear.

27.13.2 All vehicle decks, ships' ramps and lifting appliances should, so far as is reasonably practicable, be kept free of water, oil, grease or any liquid that might cause a person to slip or that might act as a lubricant to a shifting load. Any spillage of such liquid should be quickly cleaned up; sand boxes, drip trays and mopping-up equipment should be available for use on each vehicle deck.

27.13.3 All vehicle decks, ships' ramps and lifting appliances should be kept free of obstructions and loose items such as stores and refuse.

27.13.4 Seafarers should be careful to avoid electrical points and fittings when washing down vehicle decks.

27.13.5 All scuppers should be kept clear of lashing equipment, dunnage, etc.

CHAPTER 28

DRY CARGO

Note: Chapters 10, Manual handling, 16, Hatch covers and access lids, and 19, Lifting plant and operations, also have special relevance to work on dry cargo ships.

28.1 Stowage of cargo

28.1.1 This chapter concerns both packaged and dry bulk cargoes, with the exception of cargoes carried in roll-on/roll-off (ro-ro) ships, which are covered in Chapter 27, Roll-on/roll-off ferries.

28.1.2 All cargoes should be stowed and secured in a manner that will avoid exposing the ship and persons on board to unnecessary risk. The safe stowage and securing of cargo depends upon proper planning, execution and supervision by properly qualified and experienced personnel.

28.1.3 The planned procedures for the handling of cargo should be agreed with berth or terminal operators in advance of loading or unloading. In the case of dry bulk cargo (excluding grain), procedures should follow the International Maritime Organization (IMO) Code of Practice for the Safe Loading and Unloading of Bulk Carriers, with the associated IMO Ship/Shore Safety Checklist. For grain, there is more detailed guidance in the International Code for the Safe Carriage of Grain in Bulk.

28.1.4 Loading, stowage and securing of cargo other than bulk cargo is to be carried out in accordance with the ship's approved cargo-securing manual. Handling and safety instructions for securing devices are contained in sections 3.1 and/or 4.1 of the manual. Further guidance is contained in the IMO Code of Practice for Cargo Stowage and Securing (IMO Resolution A.714(17)). Cargo securing should be completed before the ship proceeds to sea.

28.1.5 All cargo should be stowed having due regard to the order of discharge at a port or number of ports. When planning the position of cargo and the order of loading and unloading, the effects that these operations will have upon access and the safety of personnel should be considered. The following points should be taken into account:

- Cargo information, including gross mass of the cargo or cargo units and any special properties detailed on board or in the shipping documents, should be recorded and used in planning.

*S.I. 1999/336 and
MGN 107(M)*

*IMO Resolution
A.714(17)*

- Wherever practicable, where more than one port is involved for loading or unloading, cargo should be loaded in layers rather than in tiers, so as to avoid the development of high vertical walls of cargo.
- Care should be taken not to overstuff lighter cargoes with heavier cargoes, which may lead to a collapse of the stow.
- Wherever practicable, cargo should be stowed so as to leave safe clearance behind the rungs of hold ladders and to allow safe access as may be necessary at sea.
- The need to walk across or climb onto the deck cargo, where this may involve an approach to an unprotected edge with risk of falling, should be minimised.
- Care should be taken to avoid large gaps next to cargo where it is stacked against corrugated bulkheads.

S.I. 1998/2241

28.1.6 Deck cargo should be stowed in accordance with the statutory requirements, and kept clear of hatch coamings to allow safe access. Access to safety equipment, firefighting equipment (particularly fire hydrants) and sounding pipes should also be kept clear. Any obstructions in the access way, such as lashings or securing points, should be painted white or other contrasting colour to make them more easily visible. Where this is impracticable and cargo is stowed against ship's rails or hatch coamings to such a height that the rails or coamings do not give effective protection to personnel from falling overboard or into the open hold, temporary fencing should be provided (see section 11.6, Guarding of openings).

28.1.7 Timber cargo decks shall be loaded, stowed and secured throughout the voyage as per the Code of Safe Practice for Ships Carrying Timber Deck Cargoes 2011, known as the 2011 TDC Code.

The purpose of the 2011 TDC Code is to ensure that timber deck cargoes are loaded, stowed and secured to prevent, as far as practicable, throughout the voyage, damage or hazard to the ship and persons on board as well as loss of cargo overboard.

The 2011 TDC Code provides:

- practices for safe transportation;
- methodologies for safe stowage and securing;
- design principles for securing systems;
- guidance for developing procedures and instructions to be included in ships' cargo-securing manuals on safe stowage and securing; and
- sample checklists for safe stowage and securing.

28.1.8 Suitable safety nets or temporary fencing should be rigged where personnel have to walk or climb across built-up cargo, and are therefore at risk of falling.

28.1.9 When deck cargo is stowed against and above ship's rails or bulwarks, a wire rope pendant or a chain, extending from the ring bolts or other anchorage on the decks to the full height of the deck cargo, should be provided and used to save personnel having to go overside to attach derrick guys and preventers directly to the anchorages on the deck.

28.1.10 Where beams and hatch covers have to be removed at intermediate ports before surrounding deck cargo is unloaded, an access space at least 1 metre wide should be left adjacent to any part of the hatch or hatchway that is to be opened. If on deck this is impracticable, fencing or lifelines should be used to enable seafarers to remove and replace beams and hatch coverings in safety (see section 11.6).

28.1.11 In the 'tween decks, guidelines should be painted around 'tween deck hatchways at a distance of 1 metre from the coamings.

*S.I. No 2367,
MGN 340(M)*

28.2 Dangerous goods and substances

28.2.1 Packaged dangerous goods are marked, labelled or placarded to indicate the contents and their hazardous or polluting properties, and this information should be used to assess any risk to seafarers and put in place necessary safety measures. Merchant shipping regulations lay down requirements for the carriage of dangerous substances and the provisions of the International Maritime Dangerous Goods (IMDG) Code, together with those contained in relevant merchant shipping notices, should be observed. The IMDG Code contains details of classification, documentation, marking and labelling, packaging, etc. and advice on such application as will meet requirements of the regulations. In particular, it lists and gives details of many dangerous substances.

28.2.2 The general introduction and the introductions to individual classes of dangerous goods in the IMDG Code contain many provisions to ensure the safe handling and carriage of dangerous goods, including requirements for electrical equipment and wiring, firefighting equipment, ventilation, smoking, repair work, provision and availability of special equipment, etc., some of which are general for all classes and others particular to certain classes only. It is important that reference should be made to this information before handling dangerous goods. Some of the requirements are highlighted in subsequent paragraphs. Where any doubts exist, advice should be sought from the Maritime and Coastguard Agency (MCA) or other competent authority.

Chapter 7.8 of the IMDG Code provides advice on special requirements in the event of an incident and fire precautions involving dangerous goods and this, in accordance with the ship's safety management system, should be followed in the event of spillage or other incidents.

28.2.3 Dangerous goods should be loaded or unloaded only under the supervision of a competent responsible officer and, if applicable, in accordance with the ship's document of compliance for the carriage of dangerous goods. Suitable precautions, such as the provision of special lifting gear as appropriate, should be taken to prevent damage to receptacles containing dangerous goods.

28.2.4 Dangerous substances in bulk should be loaded, stowed and carried in accordance with Appendix 1 of the International Maritime Solid Bulk Cargoes Code (IMSBC) published by IMO.

MSN 1706(M)

28.2.5 Emergency response procedures for the substances carried should be established, in accordance with the IMO's Emergency Procedures for Ships Carrying Dangerous Goods (EmS Guide), which should be consulted to ensure that appropriate emergency equipment is carried. The application of such measures is under the control of the master of the ship and will depend on the circumstances of the incident and the location of the ship. The equipment necessary for the execution of the emergency response should be immediately available and the crew trained and practised in its use. The Medical First Aid Guide for Use in Accidents Involving Dangerous Goods (MFAG – MSC/Circ.857) should also be available.

28.2.6 These procedures should include:

- cases of accidental exposure (see section 28.2.9 below); and
- the possibility of fire.

MSN 1870(M+F)

28.2.7 Personnel who are required to handle consignments containing dangerous substances should be able to identify dangerous goods from the labelling and placarding and should be provided with and wear personal protective equipment (PPE) (including breathing apparatus, where necessary) appropriate to the hazard involved. More information on PPE when handling dangerous substances can be found in Chapter 8, Personal protective equipment.

28.2.8 Seafarers should promptly report any leakage, spillage or any other incident that occurs and involves exposure to dangerous substances. In the event of accidental exposure, reference should be made to the MFAG published by IMO.

28.2.9 Appropriate measures should be taken promptly to render harmless any spillage of dangerous substances. Particular care should

be taken when dangerous substances are carried in refrigerated spaces where any spillage may be absorbed by the insulating material. Insulation affected in this way should be inspected and renewed if necessary.

28.2.10 Where there is leakage or escape of dangerous gases or vapours from cargo, personnel should leave the danger area and the area should be treated as a dangerous (enclosed) space (see Chapter 15, Entering dangerous (enclosed) spaces). Personnel required to deal with spillages or to remove defective packages should be provided with and wear suitable breathing apparatus and protective clothing as the circumstances dictate. Suitable rescue and resuscitation equipment should be readily available in case of an emergency (see Chapter 8, Personal protective equipment).

28.2.11 Further guidance on the handling and stowage of dangerous goods is contained in the Recommendations on the Safe Transport of Dangerous Cargoes and Related Activities in Port Areas published by IMO.

28.3 Carriage of containers

28.3.1 Containers are simply packages of pre-stowed cargo and sections of Chapters 16, Hatch covers and access lids, and 19, Lifting plant and operations, may also be relevant to their safe working. Guidance is also published by the UK's Port Skills and Safety organisation in its Health and Safety in Ports series, *SIP Leaflet 008 – Guidance on the storage of dry bulk cargo* (see the Port Skills and Safety website).

28.3.2 Where a container holds dangerous goods, the relevant guidance contained in section 28.2 should be followed. For guidance on control of substances hazardous to health, refer to Chapter 21, Hazardous substances and mixtures.

28.3.3 Freight containers should comply with the International Convention for Safe Containers 1972 (CSC), under which they must carry a safety approval plate (CSC plate). Defective containers, or containers on which the CSC plate is missing, should be reported so that they can be taken out of service. Containers should not be loaded beyond the maximum net weight indicated on the CSC plate, and should be in a safe condition for handling and carriage.

28.3.4 The equipment used for lifting a container should be suitable for the load, and safely attached to the container. The container should be free to be lifted and should be lifted slowly to guard against the possibility of it swinging or some part of the lifting appliances failing, should the contents be poorly secured, unevenly loaded and poorly distributed or the weight of contents incorrectly declared. The process of

loading and securing of goods into a container should follow the IMO/ILO/UN/ECE Guidelines for Packing of Cargo Transport Units (CTUs). Special care should be taken when lifting a container with a centre of gravity that is mobile, e.g. a tank container, bulk container or a container with contents that are hanging.

28.3.5 Safe means of access to the top of a container should be provided to release lifting gear and to fix lashings. Personnel so engaged should, where appropriate, be protected from falling by use of a properly secured safety harness or other suitable means.

28.3.6 All containers should be lashed individually by a competent person. Where containers are stacked, account should be taken of the appropriate strength features of the lashing and stacking-induced stress.

28.3.7 On ships not specially constructed or adapted for their carriage, containers should, wherever possible, be stowed fore and aft and securely lashed. Containers should not be stowed on decks or hatches unless it is known that the decks or hatches are of adequate overall and point load-bearing strength. Adequate dunnage should be used.

28.3.8 The system of work should be such as to limit the need to work on container tops. Where the design for securing containers and checking lashing makes access onto container tops necessary, it should be achieved by means of the ship's superstructure or by a purpose-designed access platform or personnel cages using a suitable adapted lifting appliance. If this is not possible, an alternative safe system of work should be in place.

28.3.9 To allow access to the tops of over-height, soft-top or tank containers where necessary for securing or cargo-handling operations, solid top or 'closed containers' should be stowed between them whenever practicable.

28.3.10 Where the ship's electrical supply is used for refrigerated containers, the supply cables should be provided with proper connections for the power circuits and for earthing the container. Before use, the supply cables and connections should be inspected and any defects repaired and tested by a competent person. Supply cables should only be handled when the power is switched off. Where there is a need to monitor and repair refrigeration units during the voyage, account should be taken of the need to provide safe access in a seaway when stowing these containers.

28.3.11 Personnel should be aware that containers may have been fumigated at other points in the transport chain, and there may be a residual hazard from the substances used.

28.4 Working cargo

*MGN 157(M),
including
MSC/Circ.886 and
MSC/Circ.888*

28.4.1 For regulations and guidance on lifting equipment and lifting operations, including examination and testing requirements, see Chapter 19, Lifting plant and operations, of this Code.

28.4.2 Safety arrangements made prior to working cargo should ensure that adequate and suitable lifting plant is available, in accordance with the register of lifting appliances and cargo gear, and that all plant and equipment and any special gear necessary is available and used. Cargo gear should be checked regularly throughout the cargo operation for damage or malfunction.

28.4.3 Repair or maintenance work, such as chipping, spray painting, shot blasting or welding, should not be undertaken in a space where cargo operations are in progress.

28.4.4 Loads being lowered or hoisted should not pass or remain over any person engaged in any work in the cargo space area, or over means of access. Personnel should take care when using access ladders in hatch squares whilst cargo operations are in progress.

28.4.5 Cargo information for goods should always provide the gross mass of the cargo or of the cargo units. Where loads of significant gross mass are not marked with their weight, the loads should be check-weighed unless accurate information is available, as provided by the shipper or packer of the goods.

28.4.6 A signaller should always be employed at a hatchway when cargo is being worked, unless the crane driver or winchman has a complete, unrestricted view of the load or total working area. The signaller should be in a position where they have a total view of the operation; where this is not possible, then additional signallers should be used to assist. Guidance for signallers is given in sections 19.9.5 to 19.9.9 and Annex 19.3.

28.4.7 Before giving a signal to hoist, the signaller should receive clearance from the person making up the load that it is secure, and should ascertain that no one else would be endangered by the hoist. Before giving the signal to lower, the signaller should warn personnel in the way and ensure all are clear.

28.4.8 Loads should be raised and lowered smoothly, avoiding sudden jerks or 'snatching'. When a load does not ride properly after being hoisted, the signaller should immediately give warning of danger and the load should be lowered and adjusted as necessary.

28.4.9 Hooks, slings and other lifting gear should not be loaded beyond their safe working loads. Strops and slings should be of sufficient size and length to enable them to be used safely and be so applied and pulled sufficiently tight to prevent the load or any part of the load from slipping and falling. Loads (sets) should be properly put together and properly slung before they are hoisted or lowered.

28.4.10 Before any heavy load is swung, it should be given a trial lift in order to test the effectiveness of the slinging.

28.4.11 Except for the purpose of breaking out or making up slings, lifting hooks should not be attached to:

- the bands, strops or other fastenings of packages of cargo, unless these fastenings have been specifically provided for lifting purposes; or
- the rims (chines) of barrels or drums for lifting purposes, unless the construction or condition of the barrels or drums is such as to permit lifting to be done safely with properly designed and constructed can hooks.

28.4.12 Suitable precautions, such as the use of packing or chafing pieces, should be taken to prevent chains, wire and fibre ropes from being damaged by the sharp edges of loads.

28.4.13 When slings are used with barrel hooks or other similar holding devices where the weight of the load holds the hooks in place, the sling should be led down through the egg or eye link and through the eye of each hook in turn so that the horizontal part of the sling draws the hooks together.

28.4.14 The angle between the legs of the slings should not normally exceed 90°, because this reduces the safe working load of the sling. Where this is not reasonably practicable, the angle may be increased up to 120° provided that the slings have been designed to work at the greater angles. However, it should be noted that at 120° each sling leg is taking stress equivalent to the whole mass of the load.

28.4.15 Trays and pallets (unit loads) should be loaded using a pallet loader where available. If slings are used, the trays and pallets should be hoisted with four-legged slings and, where necessary, nets and other means should be used to prevent any part of the load falling.

28.4.16 Bundles of long metal goods, such as tubes, pipes and rails, should be slung with two slings or strops and, where necessary, a spreader. Slings or strops should be double wrapped and secured to prevent the sling coming loose. A suitable lanyard should also be attached, where necessary.

28.4.17 Logs should be loaded or discharged using wire-rope slings of adequate size; tongs should not be used except to break out loads.

28.4.18 Cargo buckets, tubs and similar appliances should be carefully fitted so that there is no risk of the contents falling out and they should be securely attached to the hoist (e.g. by a shackle) to prevent tipping and displacement during hoisting and lowering.

28.4.19 Shackles should be used for slinging thick sheet metal if there are suitable holes in the material; otherwise, suitable clamps on an endless sling should be used.

28.4.20 Loose goods such as small parcels, carboys and small drums should be loaded or discharged in suitable boxes or pallets with sufficiently high sides, and lifted using four-legged slings.

28.4.21 Slings or chains being returned to the loading position should be securely hooked on the cargo hook before the signaller gives the signal to hoist. Hooks or claws should be attached to the egg link or shackle of the cargo hook, not allowed to hang loose. The cargo hook should be kept high enough to keep slings or chains clear of personnel and obstructions.

28.4.22 'One-trip slings' (i.e. slings that have not been used previously for lifting and are fitted to the load prior to loading) should not be taken back on board ship after the load is discharged at the end of the voyage but should be left on shore for disposal.

28.4.23 When work is interrupted or has ceased for the time being, the hatch should be left in a safe condition, with either guardrails or the hatch covers in position.

28.5 Lighting in cargo spaces

28.5.1 During cargo operations, cargo spaces should be adequately lit, avoiding strong contrasts of light and shadow or dazzle (see section 11.5). Open or naked lights should not be used. Portable lights should be adequately guarded, suitable for the task, and firmly secured in such a manner that they cannot be accidentally damaged. Portable lights should never be lowered or suspended by their electrical leads, and leads should be run so that they are clear of loads, running gear and moving equipment.

28.6 General precautions for personnel

28.6.1 Where crew are working alongside shore-based personnel in cargo operations, the same level of safety should be provided to both

shore- and ship-side personnel. Each should be aware of the others' risk assessment and procedures to ensure common understanding.

28.6.2 Personnel undertaking duties in cargo spaces should move with caution over uneven surfaces or loose dunnage, and be alert to protrusions such as nails.

28.6.3 Where vessels have been built with corrugated bulkheads, precautions such as suitable rails, grids or nets should be erected to prevent cargo handlers or other personnel from falling into the space between the rear of the corrugation and the stowed cargo.

28.6.4 Where work is being undertaken on or near the cargo 'face', the face should be secured against collapse, especially where bagged cargo may be bleeding from damage. Where it is necessary to mount a face, a portable ladder should be used, properly secured against slipping or shifting sideways, or held in position by other personnel. When work is undertaken in areas where there is a risk of falling, safety net(s) should be erected. Such nets should not be secured to hatch covers.

28.6.5 Personnel should be aware that cargoes may have been fumigated at other points in the transport chain, and there is a risk that toxic fumes may build up in enclosed spaces.

28.7 Moveable bulkheads in cargo holds

28.7.1 Moveable bulkheads are fitted in some small, multi-purpose vessels to allow more flexibility in the types of dry cargo carried from one voyage to the next.

28.7.2 There have been several serious accidents that have occurred when moving or carrying out maintenance on these types of bulkheads. Some of these accidents have led to the death of the seafarers involved. The procedures for the operation and maintenance of moveable bulkheads should be documented within the ship's safety management system.

28.7.3 Personnel undertaking duties that involve moving the position of the bulkhead or carrying out maintenance and hold cleaning should, prior to starting these duties, follow the risk assessment for these specific operations with these bulkheads.

28.7.4 Personnel carrying out these duties must be fully trained and competent in the moving operations associated with these bulkheads and, where required, with the jacking up of these bulkheads for hold-cleaning purposes. These personnel must be supervised at all times by an officer or other supervisor who is familiar with these types of bulkhead and competent to oversee such operations.

28.7.5 Seafarers must be given training prior to being given duties associated with these bulkheads.

28.7.6 Owing to the dangerous nature of the operations involved with these bulkheads, strong consideration should be given to the issuing of a permit to work for any duties associated with them.

28.7.7 In the operation of certain designs of moveable bulkhead, consideration should also be given, when jacking up these bulkheads for hold-cleaning purposes, or for inspection and maintenance purposes, to the use of additional temporary holding supports at the upper end, when the 'swing-over' wheel system for moving these bulkheads cannot be engaged.

Blank page

CHAPTER 29

TANKERS AND OTHER SHIPS CARRYING BULK LIQUID CARGOES

29.1 General

*S.I. 2015/782 and
MSN 1866(M)*

29.1.1 Seafarers appointed to work on tankers or similar vessels must meet the minimum training and qualifications requirements specified in regulation V/1 of the International Conventions on Standards of Training, Certification and Watchkeeping for Seafarers, 1978, including the 2010 Manila amendments.

29.1.2 An assessment should be made of the risks arising from bulk liquid cargoes, using any information available, and in particular the chemical data sheets contained in the *Tanker Safety Guides* (gas and chemical) issued by the International Chamber of Shipping.

*IMO EmS Guide
and IMO Medical
First Aid Guide
(MFAG)*

29.1.3 Training in emergency procedures and the use of any special emergency equipment should be given, as appropriate, to members of the crew at regular intervals. The instruction should include personal first-aid measures for dealing with accidental contact with harmful substances in the cargo being carried and with inhalation of dangerous gases and fumes.

29.1.4 Owing to the risks of ill effects arising from contamination by certain liquid cargoes, especially those carried in chemical tankers and gas carriers, seafarers should maintain very high standards of personal cleanliness, particularly so when they have been engaged in cargo handling and tank cleaning.

29.1.5 Seafarers on board responsible for the safe loading and carriage of the cargo should have all the relevant information about its nature and character before it is loaded and about the precautions that need to be observed during the voyage, and they should also be trained in handling procedures. Other seafarers should be advised of any precautions that they too should observe.

29.1.6 Rules restricting smoking and the carriage of matches or cigarette lighters and electronic devices should be strictly observed.

29.1.7 Spillages and leakages of cargo should be attended to promptly. Oil-soaked rags should not be discarded carelessly where they may be a

fire hazard or possibly ignite spontaneously. Other combustible rubbish should not be allowed to accumulate.

29.1.8 Cargo-handling equipment, testing instruments, automatic and other alarm systems should be maintained to a very high standard of efficiency at all times. Where electrical equipment is to be used in the cargo area, it should be of approved design and 'certified safe'. The safety of this equipment depends on proper maintenance, which should be carried out only by competent persons. Unauthorised persons should not interfere with such equipment. Any faults observed, such as loose or missing fastenings or covers, corrosion and cracked or broken lamp glasses, should be reported immediately.

29.1.9 Work that might cause sparking or that involves heat should not be undertaken unless authorised after the work area has been tested and found gas-free, or its safety is otherwise assured.

S.I. 1988/1638

29.1.10 Where any dangerous (enclosed) space has to be entered, the precautions given in Chapter 15, Entering dangerous (enclosed) spaces, should be strictly observed. Dangerous gases may be released or leak from adjoining spaces while work is in progress, and frequent testing of the atmosphere should be undertaken. Permit to work procedures should generally be adopted.

29.2 Oil and bulk ore/oil carriers

29.2.1 Tankers and other ships carrying petroleum or petroleum products in bulk are at risk from fire or explosion arising from ignition of vapours from the cargo, which may in some circumstances penetrate into any part of the ship.

29.2.2 Additionally, vapours may be toxic, some in low concentrations, and some liquid products are harmful in contact with the skin.

S.I. 1998/1561

29.2.3 Guidance on the general precautions that should be taken is given in the publication, *International Safety Guide for Oil Tankers and Terminals* (ISGOTT), published by the International Chamber of Shipping, Oil Companies International Marine Forum and the International Association of Ports and Harbours. Companies are additionally required, under the ISM Code, to have their own documented safety procedures. These publications and detailed procedures should be available on board and the guidance conscientiously followed.

29.3 Liquefied gas carriers

S.I. 1994/2464

29.3.1 Guidance on the general precautions that should be taken on these vessels is given in the *Tanker Safety Guide (Liquefied Gas)*

published by the International Chamber of Shipping. The International Maritime Organization (IMO) Codes for the International Construction and Equipment of Ships Carrying Liquefied Gases in Bulk (IGC) contain guidance on operational procedures.

29.3.2 It should be noted that cargo pipes, valves and connections, and any point of leakage of the gas cargo, may be intensely cold. Contact with these may cause severe cold burns.

29.3.3 Pressure should be carefully reduced and the liquid cargo drained from any point of the cargo transfer system, including discharge lines, before any opening up or disconnecting is begun.

29.3.4 Some cargoes such as ammonia have a very pungent, suffocating odour and very small quantities may cause eye irritation and disorientation together with chemical burns. Seafarers should take this into account when moving about the vessel, and especially when climbing ladders and gangways. The means of access to the vessel should be such that the cargo can be closely supervised and sited as far away from the manifold area as possible. Seafarers should be aware of the location of eyewash equipment and safety showers.

29.4 Chemical carriers

29.4.1 A bulk chemical tanker may be dedicated to the carriage of one or a small number of products or it may be constructed with a large number of cargo tanks in which numerous products are carried simultaneously side by side.

29.4.2 The products carried range from the so-called non-hazardous to those that are extremely flammable, toxic or corrosive, or have a combination of these properties, or that possess other hazardous characteristics.

29.4.3 The ship arrangements and the equipment for cargo handling may be complex and require a high standard of maintenance and the use of special instrumentation, protective clothing and breathing apparatus for entry into dangerous spaces.

29.4.4 IMO has produced codes (International Code for the Construction and Equipment of Ships Carrying Dangerous Chemicals in Bulk (IBC Code) and Interpretations of the IMO Code for the Construction and Equipment of Ships Carrying Dangerous Chemicals in Bulk (BCH Code)) for the construction and equipment of ships carrying dangerous chemicals in bulk. The codes are statutory under merchant shipping regulations. Ships carrying cargoes in bulk that are listed in the IBC Code must display for the information of all on board any data necessary for the safe carriage of the cargo, including action to be taken

S.I. 1996/3010

in the event of spills and leaks, countermeasures against accidental personal contact, and firefighting procedures and firefighting media.

29.4.5 All seafarers should be trained in the use of relevant personal protective equipment and have basic training in emergency procedures. Guidance on general operational procedures and precautions that should be followed on chemical tankers is given in the *Tanker Safety Guide (Chemicals)* published by the International Chamber of Shipping. This publication, together with the codes referred to earlier and any special safety requirements issued by the Company, should be available on board.

29.4.6 Many products carried on chemical tankers are loosely referred to as alcohols. Drinking these could lead to serious injury and death, and strict controls should be exercised when carrying such cargoes in order to prevent pilfering.

CHAPTER 30

PORT TOWAGE INDUSTRY

30.1 General

30.1.1 This section covers seafarers engaged on tugs that are involved in towage operations within port/harbour limits and provides general guidance on safety. Where other documents or sections of this Code apply, these are referenced and should be read in conjunction with this chapter.

30.1.2 Before beginning towing operations, a comprehensive plan should be prepared, taking account of all relevant factors, including sea state, visibility and the findings of the risk assessment.

30.2 Watertight integrity

30.2.1 The watertight integrity of a tug should be maintained at all times. When the tug is engaged on any towage operation, all watertight openings should be securely fastened. The tug crew should avoid working below the waterline at this time.

30.2.2 All watertight openings should be marked with a sign stating that they are to remain closed during towage operations. Any such openings used whilst moving about the tug during a towage operation should be re-secured immediately after use. Signs should conform with Chapter 9, Safety signs, of this Code.

30.3 Testing and inspection of towing equipment

30.3.1 Towing hooks and alarm bells, where fitted, should be inspected daily.

30.3.2 The emergency-release mechanisms on towing hooks and winches should be tested, both locally and where fitted remotely, at frequent intervals to ensure correct operation.

30.3.3 All towing equipment in use should be inspected for damage before undertaking and after completing a tow.

30.4 Connecting and disconnecting the towing gear

30.4.1 Before commencing a tow, the master should determine which towing gear is suitable for the operation and instruct the crew accordingly.

30.4.2 When receiving heavy lines, the tug crew should be aware of the risk of injury through being struck by a 'monkey's fist' or other weighted object attached to a line. They should stand clear of and where possible indicate the area that the heaving line is to be thrown down to. The use of dangerously weighted heaving lines should be reported.

30.4.3 When connecting to the assisted vessel, the tug crew should ensure that the towing gear is clear of any obstructions, able to run freely and is run out from the tug in a controlled manner.

30.4.4 During disconnection, seafarers on deck should be aware of the risk of injury if the towing gear is released by the assisted ship in an uncontrolled manner, and avoid standing directly below. They should also be aware that any towing gear that has been released and is still outboard may 'foul' on the tug's propeller(s), steelworks or fendering, causing it to come tight unexpectedly.

30.5 Use of bridle/gog rope during towing operations

30.5.1 A suitable bridle or gog/gob rope or wire should be used in circumstances where the towline is likely to reach such an angle that a 'girting' situation may arise.

30.6 Seafarer safety during towing operations

30.6.1 Once the towing gear is connected, the deck crew should indicate this to the master and then clear the area and, if it is absolutely necessary to remain on deck, seafarers should stand in a safe position. If seafarers are required to attend the towing gears during the towing operation, the length of time exposed should be kept to the absolute minimum.

30.6.2 During towage operations, the towing gear, equipment and personnel should be continuously monitored and any change in circumstances immediately relayed to the master. This is particularly important on tugs where the master has a restricted view of those areas/personnel.

30.6.3 During all towing operations, where a tug is made fast to the assisted ship, the crew should be aware that the towing gear may have to be released in an emergency situation, and that this may occur without any warning.

30.6.4 Tug crews should wear appropriate personal protective equipment (see Chapter 8, Personal protective equipment).

30.7 Communications

30.7.1 Prior to undertaking the tow, effective means of communication must be established between the tug and the master (or pilot) of the assisted ship and relevant information (e.g. speed during connection) should be exchanged. Secondary/alternative means of communication, where possible, should also be agreed.

30.7.2 Internal communications are equally important and the tug master should ensure that the crew are aware of the intended operation, including any special circumstances or instructions. An effective means of communication should be established between the master and crew before the operation begins and maintained throughout.

30.8 Interaction

MGN 199(M)

30.8.1 Interaction and its effects on a tug and its handling are well known and appreciated in port/harbour towage. Masters and crew are reminded that these effects increase with speed. Marine guidance note MGN 199(M) provides guidance on the effects of interaction.

30.8.2 In areas where interaction exists, and when manoeuvring alongside a ship, the master should be aware of the possibility of underwater obstructions, such as bulbous bows and stabiliser fins, and areas of the ship's sides, such as pilot doors, which are to be avoided. The use of bow/stern thrusters and azimuth propulsion systems by the ship may present a hazard to the tug.

30.8.3 When in close proximity to or coming alongside an assisted ship, the crew should be aware of interaction and the effect it may have on the tug. This may take the form of sudden movement or contact and result in loss of balance or movement of equipment and other objects.

30.9 Escorting

30.9.1 Escorting as a regular operation is common within the port towage industry. It should only be carried out after investigating the suitability of the tug for the operation and agreeing a plan. This type of operation is carried out in both passive and active modes: passive when running free in close attendance and active when fast to the tow.

30.9.2 If active escort is being undertaken, the form of towage can be direct or indirect, depending on the speed of the tow. When fast to the tow, masters should be aware that increased loads can be applied to towing gear, especially when operating in the indirect mode.

Blank page

CHAPTER 31

SHIPS SERVING OFFSHORE OIL AND GAS INSTALLATIONS

31.1 General information

31.1.1 The offshore industry has changed much over the years, affecting the way the industry works. The safe working practices set out in this chapter reflect those changes.

31.1.2 There are many different types of vessels now in regular use other than the standard platform supply vessel (PSV) or anchor handling tug supply (AHTS). These range from emergency response and rescue vessels (ERRVs) and their daughter crafts to more flexible types of multi-role vessels that cover the ERRV role, inter-field transfers and general cargo activities. In addition, there are a wide range of specialist vessels, involved in drilling, construction, platform maintenance, accommodation, diving support and other functions. This chapter provides general guidance for offshore operations, and in particular for supply vessels and anchor handling. Sources of guidance for other specialist vehicles are listed in Appendix 2, Other sources of information.

31.2 Responsibilities

31.2.1 The master has the responsibility to stop any operations that threaten the safety of the vessel or crew or the installation's integrity.

31.2.2 Other pressures, whether work related or commercial, must not interfere with the master's professional judgement and they must inform the relevant parties of any serious conflict of interests arising from instructions or activities of other parties.

31.2.3 The offshore installation manager (OIM) controls the entry of all vessels into the 500-metre zone around the installation and can modify or terminate any support vessel activity that they regard as hazardous to the installation or persons on it. However, the master of the vessel has the final responsibility for ensuring the safety of the vessel and the crew.

31.2.4 The OIM may delegate operational tasks to other competent installation personnel.

31.2.5 All personnel are responsible for both their own safety and the safety of those they work with. They must always act to prevent accidents and may also terminate cargo operations on safety grounds at any time.

31.3 General precautions

31.3.1 Seafarers working in cold and wet conditions should wear waterproof garments over warm clothing. Arrangements should be made for relief at suitable intervals to avoid undue exhaustion and hands and limbs becoming cold and numb. Consideration should be given to breaks for seafarers if operations are to continue for several hours.

31.3.2 If working on deck cannot be avoided during bad weather, consideration should be given to adjusting the ship's heading and speed to provide as safe a platform as possible. Lifelines should be rigged on the working deck to facilitate safe movement. Decks should, as far as practicable, be kept free from ice, slush, algae and any substance or loose material likely to cause slips and falls. A lookout should be kept to give warning of imminent oncoming, quartering or following seas, or the operation suspended until the risk of shipping seas is over.

31.3.3 During hours of darkness, sufficient lighting should be provided at access ways and any work location to ensure that obstructions are clearly visible, that seafarers working on deck can be clearly seen from the bridge and installation, and that the operation may be carried out safely. Lighting should be placed so that it does not dazzle the navigational watch, interfere with the prescribed navigational lights nor dazzle the deck crew when carrying out cargo operations.

31.3.4 Owing to the unpredictable movement of vessels, especially in regard to the rise and fall, the use of tag lines should be considered only in exceptional circumstances and after a thorough risk assessment.

31.3.5 All operations on deck must be risk assessed and discussed and agreed with all involved via a toolbox talk prior to the work commencing.

31.4 Personal protective equipment

31.4.1 Personnel who are working in cold and wet conditions should wear waterproof garments over warm clothing.

31.4.2 If there is a chance that a seafarer could be knocked or washed overboard during cargo operations, then a self-inflating personal flotation device (working lifejacket) should be worn so as not to impede working movements. It must be capable, when activated, of turning the seafarer onto their back if unconscious.

31.4.3 When carrying out cargo operations, as a minimum, coveralls, high-visibility vest, safety helmet, safety boots, safety eyewear as appropriate and gloves should be worn.

31.4.4 The Company should assess the working areas of working decks to ensure that the noise levels, generated from both the vessel and the neighbouring platform, are within acceptable levels. If not, suitable hearing protection should be provided that does not restrict or inhibit communication on the installation or between the installation and the bridge.

Offshore support vessels

31.5 Communications

31.5.1 Where practical, and when using very high frequency (VHF), communications between the vessel and the platform should be conducted on a different channel from the one used for general in-field communications, because this allows for better and less interrupted communications.

31.5.2 At all times that work is being done on the deck, there should be an efficient means of radio communication between the bridge, crane and seafarers involved. A back-up system should be available between the bridge and seafarers involved and this can either be a tannoy system or additional radio.

31.5.3 A proper radio watch must be maintained on the bridge. This includes the appropriate emergency and calling channels as well as the current working channels.

31.6 Carriage of cargo

31.6.1 This section should be used in conjunction with the Oil & Gas UK publication, *Best Practice for the Safe Packing and Handling of Cargo to and from Offshore Locations*, Guidelines for Offshore Marine Operations (G-OMO) and local supplement, and the International Maritime Dangerous Goods (IMDG) Code where applicable. Please see Appendix 2, Other sources of information, for further information.

31.6.2 The master is responsible for the safe and correct loading of their vessel, and should give due consideration to any known discharge priorities or order of discharge for the cargo when deciding how and where it will be loaded. They should ensure that the cargo is stowed in such a way as to allow access for the seafarers to lifts without the need to climb over cargo. This will help avoid the temptation to 'cherry pick' a specific container.

31.6.3 When at sea, only seafarers involved in the cargo operation should be on the cargo deck. Other seafarers should stay clear of the work area.

31.6.4 All oncoming cargo should be checked against the manifest to ensure that only the cargo listed is loaded. If there are any discrepancies, then loading should be stopped until they can be resolved. If necessary, the cargo should not be loaded. A cargo plan should be produced so that locations of all items are known. There should be pre-notification of any dangerous goods.

31.6.5 Before securing, all containers should be given a visual check to ensure there are no defects, the container test is in date and there are no trapped strops or potential dropped objects. All containers should have been inspected prior to loading, so the check that is carried out by the deck crew will be to ensure that nothing has been damaged in transit and nothing obvious has been missed.

31.6.6 When stowing cargo, attention should be given to potential snagging hazards. These include, but are not limited to, stacking points and pad-eye protectors, which may be larger than usual, tie-down hooks, door handles, crash barriers or even entrances to safe havens.

31.6.7 When loading half-height containers, consideration should be given to whether the lifting strops may get caught on the containers' contents when discharging. A suitable material should be used to cover the equipment inside and prevent the potential for snagging hazards. This may include nets, tarpaulins, wood battens, roof bars, cord lashing and crating of equipment.

31.6.8 Boat-shaped skips should not be used.

31.6.9 Wherever possible, scaffolding tubes and/or boards should be pre-slung into an appropriate cargo-carrying unit designed for four-point lifting.

31.6.10 Cargo operations can continue for several hours. In such cases, careful consideration should be given to ensuring that all involved remain alert. All seafarers must ensure that they follow the hours of rest requirements at all times. This is particularly important if the vessel is sailing into port immediately after cargo work or sailing directly prior to it.

31.6.11 The crane operator may terminate a cargo operation on safety grounds.

31.6.12 Areas of the deck that are not to be used for cargo stowage should be clearly marked or otherwise indicated.

31.6.13 The safe securing of all deck cargoes should be checked by a competent person before the vessel proceeds on passage. To aid unloading at sea to be carried out safely, independent cargo units should, as far as practicable, be individually lashed. Where it is not practical to lash individual pieces of cargo, then groups of lifts intended for the same delivery location should be secured together. Lashings should, where practicable, be of a type that can be easily released and maintained.

31.6.14 All lashings should be checked at least once during each watch whilst at sea. Seafarers engaged in the operation should be closely supervised from the bridge, particularly in adverse weather conditions. At night in bad weather, a searchlight should be used to aid remote checking of lashings to avoid placing personnel at risk.

31.6.15 Where fitted, pipe posts should be used to restrain the movement of tubulars.

31.7 Bulk cargo operations

31.7.1 Cargoes carried in bulk range from dry-powdered products such as cement or barites to liquid products such as water, fuel oil, brine and oil-based muds.

31.7.2 Discharging bulks pose a significant risk to the environment as well as to personnel. As such, before undertaking any bulk cargo operation, the following should be followed:

- Agreement should be attained prior to the vessel entering the 500-metre safety zone as to what product is required and how much product will be discharged, or received by, the installation.
- Pressure ratings of all equipment should be checked to ensure that they are suitable for the operation.
- Prior to commencement, the pumping rate and density of the product should be agreed, as should the proposed sequence of events. Only once these are agreed amongst all involved parties should the operation commence.
- The pumping rate should start off very slowly, to check that all connections are secure and the product is going into the agreed tank(s). Once this has been confirmed and all checks have been made, then pumping can be increased to the agreed rate. Further checks of connections should be made once the final pumping rate has been reached.
- Each party should give sufficient warning if tanks need to be changed over. Confirmation should be given once this is done.

- The vessel and the platform should regularly confirm the amount discharged or loaded. If there are any discrepancies, then the operation should stop until the error can be ascertained.
- If communications are lost at any time, then the operation should be stopped.
- Appropriate deck personnel should be available and nearby during the entire operation.
- The master and/or officer of the watch should be able to see the bulk hoses at all times.
- When discharging liquids, appropriate save-alls should be fitted and adequate spill equipment should be ready for immediate use.
- Valves shall not be closed against the cargo pump.
- Unregulated compressed air should not be used to clear bulk hoses because this can damage tanks.
- Compressed air should not be used to clear hoses that have been used for hydrocarbons because this increases the risk of explosions.
- All hoses should have sufficient flotation collars fitted.
- The hose used should be the correct type for the task.

31.8 Approaching installation and cargo-handling operations

31.8.1 At no time is an installation's exact position to be used as a global positioning system (GPS) waypoint. Waypoints should always be offset from the installation and outside the 500-metre safety zone.

31.8.2 At no time should a vessel enter the installation's 500-metre zone in autopilot. The vessel should be in hand steering.

31.8.3 Prior to entering a safety 500-metre zone, an appropriate checklist should be carried out. Normally these are Company or installation specific. A typical example of such a checklist can be found in the G-OMO publication. An entry should also be made in the vessel's logbook once these checks have been completed.

31.8.4 The approximate working position needed for the planned operation should be calculated prior to entry to the 500-metre safety zone.

31.8.5 After entry into the 500-metre safety zone, the vessel should proceed to a 'set-up' position that will be at least 1.5 ship's lengths from the installation, in a drift-off situation, or 2.5 ship's lengths in a drift-on situation. This set-up period will be carried out for a minimum of

ten minutes so as to allow for an accurate assessment of the prevailing conditions and their effect on the vessel.

31.8.6 The current industry weather working guidelines should be followed. These can be found in the G-OMO publication.

31.8.7 Cargo operations should be stopped if the vessel requires the use of more than 45% power on its engines and/or thrusters.

31.8.8 At all times, personnel should be alert to the danger of being hit or crushed should items of cargo swing during a lift or become dislodged through sudden movement of the ship. All seafarers should only approach a lift when it is safely on the deck and the weight is off the wire.

31.8.9 Once a lift is connected, the seafarers should retreat to an appropriate safe haven before it is lifted.

31.8.10 If any back-loading has to take place from the installation during off-loading of cargo from the vessel, care should be taken to ensure that the cargo taken on board is immediately secured against movement until it can be properly stowed.

31.9 Transfer of personnel by ship to/from installation

31.9.1 Circumstances may make it necessary to transfer installation personnel to or from a vessel. There are a number of ways of achieving this.

31.9.2 All personnel to be transferred should be briefed by a responsible person.

31.9.3 Personnel to be transferred should wear working lifejackets and other personal protective equipment (PPE) suitable for the environmental conditions.

31.9.4 Throughout the operation, a lifebuoy, boathook and heaving line should be kept immediately available on board the vessel for use in the case of emergencies.

31.9.5 The arrangements for rescue and recovery of persons near the installation, which are set out in the installation's emergency response plan, should be in place.

31.9.6 Personnel transfer is to commence only if all identified parties have confirmed readiness.

31.9.7 All personnel transfers should only take place after a thorough risk assessment has been completed and a toolbox talk carried out with all personnel involved.

31.9.8 Further advice and guidance on personnel transfers may be found in the G-OMO publication.

31.10 Transfer by specialist craft

31.10.1 When the weather is suitable, transfers can be carried out by specialised small craft subject to the vessel having enough trained personnel to carry out such a task safely.

31.10.2 The master of the ship providing the boat should be responsible for the operation. Due consideration should be given to the effect of prevailing conditions on the safety of the transfer. As guidance, typically, such operation should not take place if the prevailing conditions include one of the following:

- The significant wave height exceeds 2.5 metres.
- There are hazardous amounts of ice or snow on any of the landing areas to be used. These include access and egress routes.
- The visibility drops below 500 metres.
- If the wind speed exceeds 25 knots.

31.10.3 Personnel transfers by craft should not routinely take place during the hours of darkness. However, if in exceptional circumstances this cannot be avoided, the following precautions should be implemented:

- All transfer areas should be illuminated adequately.
- All lifejackets should be fitted with a high-intensity strobe light and/or a satellite transponder.
- Checks should be made to ensure that retro-reflective tape on jackets, coveralls, etc. is not obscured.

31.10.4 Boarding and disembarkation should be carried out in an orderly manner under the coxswain's direction.

31.10.5 The boat's coxswain should ensure an even and safe distribution of passengers. Passengers should not stand up or change their positions during the passage between ships save under instructions from the coxswain.

31.10.6 The mother ship should establish communication with the receiving vessel prior to the commencement of the operation and should

maintain continuous visual contact with the boat concerned throughout the transfer. Any boat used for personnel transfers should have at least two means of radio communications.

31.10.7 If the transfer of personnel involves a standby vessel, the master should bear in mind that their vessel must, at all times, be ready to fulfil its standby vessel duties.

31.10.8 Transfers from one vessel to another shall not take place within the 500-metre zone of any installation without explicit permission of the OIM.

31.10.9 Radio communications should be set up between the mother ship, standby vessel (if it is not carrying out the transfer) and receiving vessel.

31.10.10 The boat should be crewed by no fewer than two experienced persons, at least one of whom should be experienced in handling it. Lifejackets and, if necessary, suitable protective clothing should be worn by all personnel.

31.11 Transfer by personnel carrier

31.11.1 Transfers from ship to installations are sometimes carried out by some type of personnel carrier that is lifted by the platform's crane. These vary in design and redundancy, and can range from simple rope netting to more elaborate systems where individuals are strapped in. However, the dangers are similar and must be mitigated against. Once again, further advice and guidance on personnel transfers using a carrier system may be found in the G-OMO publication.

31.12 Transfer of personnel by ship to installation by transfer capsule

31.12.1 The transfer capsule must be on deck and stable before personnel approach it.

31.12.2 Personnel should be escorted to the landing/loading area and approach the capsule one at a time.

31.12.3 Personnel should be secured in the transfer capsule in accordance with the manufacturer's user guidance.

31.12.4 The capacity of the capsule must not be exceeded and it is recommended that, in any case, the load should be no more than five personnel who should be evenly distributed to ensure maximum stability.

31.12.5 No baggage should be taken into the capsule. Baggage should be transferred in a separate baggage container.

31.12.6 Before lifting commences, all personnel (OIM, vessel master and crane operator) must be in agreement that they are in readiness for the transfer. Adequate radio communications should be maintained throughout the transfer.

31.12.7 The capsule should be lifted clear of the vessel and swung up and out as smoothly as possible. Once over the sea, the capsule should be lifted to the installation.

31.12.8 Once over the installation, the capsule should be lowered to the lifting/landing area. Tag lines should be cleared before the capsule is finally lowered to the landing area.

31.12.9 Transit personnel should remain seated and secured until the transfer capsule is stable on the deck and the installation personnel have removed securing and provided an escort to the reception on the installation.

31.13 Transfer by personnel basket

31.13.1 The following procedures should be observed for the transfer of personnel from ship to installation by a personnel carrier:

- The equipment should be steadied when it is lowered to the deck. Tag lines may be used and the risk assessment must cover these. Tag lines should never be wrapped around the hands.
- Luggage should be secured within the appropriate space in the carrier or taken up separately.
- Personnel to be transferred should wear lifejackets and other PPE suitable for the water and sea conditions.
- Personnel transferring should be evenly distributed around the carrier to ensure maximum stability.
- If using a basket type of carrier, personnel should stand outside the basket with feet apart on the board and the basket securely gripped with both arms looped through.
- When the officer in charge is satisfied that all are ready and at an appropriate moment having regard to the movement of the ship in a seaway, the basket should be lifted clear of the vessel and then swung up and out as quickly as possible before being carefully hoisted up to the installation.
- Radio communications should be set up between ship, standby vessel (if it is not carrying out the transfer) and installation.

31.14 Transfer of personnel by gangway

31.14.1 The master of the transfer vessel, installation OIM and ERRV master must discuss the prevailing weather conditions before deciding whether it is safe enough for the transfer to proceed. Operations should only take place in the hours of daylight.

31.14.2 Transit personnel should be escorted to the gangway access area and must only use the gangway under the direction of the gangway operator.

31.14.3 Once on the installation, transit personnel are to be escorted to the reception area.

31.14.4 The capacity of the gangway should not be exceeded.

31.14.5 Personnel baggage should not be carried on the gangway. Baggage should be transferred through the use of a separate baggage container.

31.15 Further guidance

Further advice and guidance on offshore support vessel operations may be found in the G-OMO publication and the various Oil & Gas UK publications.

31.16 Anchor handling

31.16.1 Anchor handling is generally carried out by vessels commonly known as anchor handling towing supply (AHTS) vessels. As the name suggests, they are multi-purpose vessels that can carry out a number of important roles. However, generally, their primary purpose is anchor handling. This guidance should be used in conjunction with the anchor handling section of G-OMO.

31.16.2 All anchor-handling jobs should be risk assessed and the findings disseminated to all those involved via a toolbox talk or similar.

31.16.3 If the AHTS vessel is engaged in cargo activities, then the safety precautions and procedures for supply vessels should be followed.

31.16.4 Owing to AHTS vessels having a stern roller, if general supply work is undertaken by an AHTS vessel, some form of barrier is needed to prevent cargo from going over the stern. This may be something simple such as cargo chains or it can be something purpose built, such as moveable bulwarks or railings.

31.16.5 Care should be taken on the metal decks of these vessels because they can increase the chances of slips, trips and falls. They should be regularly cleaned to prevent any build-up of algae or other residues.

31.16.6 During bad weather, lifelines should be rigged on the working deck to facilitate safe movement. Decks should, as far as practicable, be kept free from ice, slush, algae and any substance or loose material likely to cause slips and falls. This is particularly important for the metal section of the deck.

31.16.7 Anyone working on the deck should wear a working lifejacket at all times because of the open stern. Any lifejacket or flotation device used must be able to turn the casualty onto their backs if they are unconscious.

31.16.8 Many items used in anchor handling are large and heavy. Care should be taken when manual handling any equipment and, if necessary, two persons should be used.

31.16.9 Whenever an anchor is being lowered over the stern or retrieved, all seafarers should be off the working deck and within a safe area.

31.16.10 Before seafarers go back on deck, the chain should be secured in the 'shark jaws' or similar securing device.

31.16.11 If anchors have been retrieved from deep water, there will be a lot of tension stored within the chain or pennant. When the pin is removed, this tension will cause the pennant or chain to spin and fly into the air. It is important that all seafarers are in an appropriately safe position.

31.16.12 **Never** walk near or over a 'live' wire on the deck. A live wire is one that is in use, under tension or has the potential to come under tension.

31.16.13 To reduce the likelihood of seafarers walking over a live wire, duplicate tools should be positioned on both sides of the working deck. This allows seafarers to remain on one side of the wire at all times.

31.16.14 All equipment used is to be maintained and operated in accordance with manufacturers' instructions.

31.16.15 There should be oxy-acetylene (or similar) cutting gear, with adequate gas, available for immediate use if needed.

31.16.16 Seafarers should ensure that the stowage of anchors and equipment are secured in line with the planned operation, and be aware of the risk of such items moving when unsecured.

31.16.17 Certain types of anchors are unstable and may not sit well on a flat deck. This should be considered during the initial risk-assessment stage so that adequate securing arrangements can be provided.

CHAPTER 32

SHIPS SERVING OFFSHORE RENEWABLES INSTALLATIONS

32.1 General

32.1.1 This chapter considers good practice on vessels supporting the construction, operation and maintenance of offshore renewable energy installations (OREIs). Vessels are needed for survey work, transporting components and materials, transfer of personnel, construction work, dive support and accommodation.

MGN 372(M+F)

32.1.2 Guidance on operation of vessels transiting in the vicinity of OREIs is published in MGN 372(M+F).

*S.I. 2002/1587
MSN 1762(M+F)*

32.1.3 Safety for diving operations is subject to HSE regulation and to the Merchant Shipping (Diving Safety) Regulations 2002 and MSN 1762(M+F).

32.2 Responsibility for offshore renewables personnel

S.I. 2015/51

32.2.1 While the vessel provider may be a contractor with duties under Construction (Design and Management) Regulations 2015, this does not in any way compromise the vessel master's duty to ensure the safety of the vessel, crew and passengers.

32.2.2 Those employed in the development, construction and maintenance of offshore windfarms may not have much experience of working in a maritime environment. Their employer has a responsibility to ensure that they receive the information, instruction, training and supervision necessary to safeguard their health and safety. The master of the vessel should also make certain that the personnel carried are familiar with emergency procedures on board, and give appropriate instructions and guidance to ensure that they are aware of the vessel's working practices in so far as they affect them.

32.3 Coordination

32.3.1 It is likely that a large number of organisations will be involved during both the construction and ongoing operation of OREIs.

Coordination is therefore key. Each OREI should have arrangements in place for the:

- provision of vessel traffic information and advice to masters;
- management and coordination of all site work/activities; and
- emergency response – see section 32.6.

32.3.2 Any marine operations within the area should be approved through the marine coordination arrangements that are already in place. Clear lines of responsibility and reporting should be established.

32.3.3 In addition, when planning work activities that involve more than one vessel or a vessel and an installation, it is important to identify any differences in their safety procedures, carry out a risk assessment and agree actions in advance that are clearly understood by all.

32.3.4 Vessels often work in close proximity to turbines or other structures, and to other vessels. Even where activities do not directly involve working together with other vessels/installations, a risk assessment should consider the impact of each vessel's activities on others. Where necessary, a sequence of actions and safe procedures should be agreed before the work starts.

32.4 Safe means of access to installations

32.4.1 Guidance on safe means of access is in Chapter 22, and the guidance for special circumstances in section 22.9 is particularly relevant.

*S.I. 2005/735
S.I. 2007/114*

32.4.2 Where passengers/industrial personnel or crew are accessing or leaving installations from a vessel, a risk assessment of the transfer arrangements should be undertaken and appropriate safety measures put into place to ensure the safety of those involved. Additional safety precautions should be taken during the hours of darkness. The arrangements during transfer must be compatible with the specific offshore installation and comply with the statutory standards for work at height regulations. The vessel should be properly equipped and/or modified (taking into account the design of the access point on the installation) to allow the transfer to be undertaken without unnecessary risk. A proper embarkation point should be provided and the boarding procedure clearly agreed.

32.4.3 The relative movements of the vessels in varying sea, tide and swell conditions make the judgement of when to effect a transfer crucial. The master responsible for the transfer operation should have full and direct sight of the area of transfer. In addition, the master and at least one designated crew member should be able to communicate

at all times with the person making the transfer. It is recommended that vessels undertaking ship-to-ship transfers while under way should carry equipment designed to aid in the rapid recovery of a casualty from the waters.

32.4.4 Those transferring and those working on exposed decks during transfer should wear a personal flotation device. Consideration should be given to requiring an immersion/survival suit to be worn, particularly in cold conditions. The transfer of baggage or other items should be carried out by the crews of the vessels and not by those transferring.

Further guidance on the transfer of personnel to and from offshore vessels and structures can be obtained from the International Marine Contractors Association (IMCA).

32.5 Carriage and transfer of dangerous cargoes

MGN 280(M)
MGN 497(M+F)

32.5.1 Where a workboat carries more than 30 kg or 30 litres net total quantity of dangerous goods, whether used on board for its own purposes or used by the industrial personnel for their own work, the vessel generally requires a Document of Compliance to Carry Dangerous Goods (DoC DG). This is issued by the MCA, and the master and persons ashore responsible for allocating stores/equipment to be carried should receive training in the requirements of the International Maritime Dangerous Goods (IMDG) code. MGN 497(M+F) gives guidance on the storage of dangerous cargoes on board. For detailed requirements that should be complied with, refer to: MGN 280(M); the Workboat Code, Industry Working Group Technical Standard; or the Workboat Code, Edition 2.

32.6 Emergency response plans

32.6.1 OREI operators should have in place an Emergency Response Cooperation Plan agreed with MCA SAR Operations for the construction, operation and decommissioning phases of any OREI. These plans are designed to ensure that HM Coastguard (HMCG) and SAR resources have information about the fundamental details of an OREI and that both the developer/operator and HMCG have access to emergency contact numbers to permit rapid contact, information sharing and effective cooperation during an emergency situation. This will ensure that incidents arising on the site are effectively managed. Those operating vessels in the area may be required to take part in testing of the arrangements. The master should ensure that all seafarers on the vessel are familiar with the plan, and comply where appropriate with the arrangements set out.

32.7 Other sources of information

32.7.1 Further industry guidance is available (see Appendix 2).

CHAPTER 33

ERGONOMICS

33.1 General

33.1.1 Ergonomics deals with the interaction between humans and work, and covers three principal areas of work: design and environment, work processes and organisation.

Design and environment:

- Workplace design, layout, controls, displays, temperature, light, noise, smell, vibration.
- Workload and fatigue.
- Safe working posture.

Work processes:

- Mental workload, fatigue and work-related stress.
- Human reliability, errors and violations.
- Competence, capability and training.

Organisation:

- Communication and teamwork.
- Policies, procedures and work instructions.
- Quality management and assurance.

33.1.2 The quality of shipboard ergonomics can have a significant role to play in safety as well as efficient operational performance. Ships designed and built around sound ergonomic principles are generally easier to operate, more efficient, less stressful, safer and more resilient.

33.1.3 Similarly, the quality of procedures, operating instructions, work instructions and maintenance instructions can play a significant role in operational performance and safety. Procedures and instructions that are clear, logical, consistent, easily understood by all users and fit for purpose will reduce violations and lead to safer operations.

33.1.4 However, often seafarers will need to work in less than ideal circumstances. The following advice is offered to help meet the challenge of working safely and efficiently in such circumstances.

Guidance for seafarers

- Familiarise yourself with the layout of your working areas.
- Assess how the layout could affect your situational awareness and working practices during routine and emergency operations.
- Be aware that risk factors do not operate in isolation – they combine and multiply.
- Remain vigilant and take extra care to maintain situational awareness at all times.
- Effective teamwork and communication will be even more important – help each other.
- Do not allow yourself, or others, to be drawn into taking shortcuts or violating procedures.
- Raise concerns about poor ergonomics or procedures at every opportunity.
- Routinely consider ergonomics as part of safety meetings.
- Propose effective solutions, modifications, changes to procedures, etc.
- Be aware of the effect of frustration, fatigue and stress on behaviour and performance.
- Ensure that everyone is completely familiar with the on-board equipment and fully competent in its use.
- Be active in procedural or work instruction review.
- Be assertive in advising the shore-side organisation of the need for any changes.

33.1.5 More information about applying ergonomic principles can be found in Annex 33.1.

33.2 Work with display screen equipment

33.2.1 In this chapter, display screen equipment (DSE) includes devices or equipment that have an alphanumeric or graphic display, such as display screens, laptops, touch screens and other similar devices. There are no specific regulations governing health and safety in the use of DSE that apply to UK ships. This section therefore gives guidance only, reflecting best practice ashore.

33.2.2 Seafarers should be given adequate individual training in the use and capabilities of DSE. This training should include any risks from DSE work and the controls in place; and where possible:

- how to adjust equipment settings;
- how to adjust furniture;
- how to organise the workplace to avoid awkward or frequently repeated stretching movements; and
- whom to contact for help and to report problems or symptoms.

33.2.3 Although the relevant regulations do not apply on ships, it is recommended that any seafarer using DSE as part of their work for continuous periods of an hour or more on a daily basis be provided with an eye test by a qualified person on request and at no cost to the seafarer.

33.2.4 Lighting should be adequate for the task, with glare and reflection cut to a minimum, and the display on screen should be clear and easy to read. The operator should adjust the brightness and contrast to suit the lighting. When appropriate, the operator should be given short rest periods away from the equipment.

33.2.5 Certain forms of medication may impair working efficiency on DSE. Personnel should be aware of this possibility and seek medical advice if necessary.

33.2.6 Further guidance on the safe use of DSE in an office environment can be obtained from the Health and Safety Executive (HSE) that produces various leaflets including 'Working with display screen equipment (DSE)'. Leaflets can be obtained from the HSE website.

Blank page

Annex 33.1 Ergonomics

The underpinning principle of effective ergonomics is to make machines, equipment, processes and organisational policies that fit the actual needs of people who use them. This is known as user-centred design.

In an ideal world, effective user-centred design would be the norm. In reality, it is often the case that people have to adjust as best they can to fit the working environment they are given. This presents a number of challenges for working safely and efficiently, and seafarers need to be extra vigilant and mindful of their tasks.

Challenges of poor ergonomics

Design and construction

- The design of ships, layout of workspaces and arrangement of controls and displays is not always ideal. Important or frequently used controls are not readily at hand, and controls and displays are not arranged in a logical sequence that supports work tasks, or are difficult to see, identify, distinguish and read.
- Working and living environments may be uncomfortable due to heat or cold, noise, vibration, smell or poor lighting. Communication may be difficult, escalating any existing language difficulties. Access may be inadequate; spaces may be cramped, making it difficult to operate tools and equipment.
- A seafarer can encounter physical hazards as part of the ship's design – slips, trips and falls are an everyday hazard.

Work processes

- Manual work (e.g. cargo handling, maintenance and repair work) can be physically demanding and place considerable strain on the mind and body. The most suitable tools and equipment may not be available and the working space may not be adequate to allow a seafarer to carry out a job safely using correct tools or safe ergonomic body posture, which can encourage shortcuts and procedural violations.
- Working at a poorly adjusted workstation for long periods can have an adverse effect on body posture and long-term health and musculoskeletal injuries, as well as induce fatigue.
- Long hours and demanding work cause fatigue and can lead to stress. Poor ergonomically designed ships, equipment, tools and work processes that do not support seafarers effectively and where they continually have to adjust to their environment and find workarounds will require a significant increase in physical and mental workload, which will greatly increase the likelihood of fatigue and stress, errors and accidents.

- Poorly written procedures and instructions that are difficult to understand may have a direct bearing on the safe and successful operation of ships and ships' equipment. Crews may interpret the instructions in different ways, leading to inconsistencies and errors. Instructions that are difficult to follow may lead to procedural violations as crews struggle to find a workaround. This in turn may lead to increased stress and fatigue, both significant contributors to accidents. Procedures and instructions must make life easier for crews.

Risks

- Ergonomic deficiencies can increase stress and fatigue and encourage shortcuts or procedural violations. They can cause operational distractions that will adversely affect situational awareness and operational efficiency and increase the likelihood of errors, not only in stressful or emergency situations but also during routine operations unless extra vigilance is taken.
- Safe operations depend upon well-trained seafarers who are familiar with their ship and fully competent with the precise equipment and procedures used on it. Degraded levels of competence can lead to increased workload, increased fatigue and stress and an increased error rate. Poor ergonomic design of ships, equipment and procedures will increase any effect of degraded competence.
- Organisational failures, including those that affect design and procedural ergonomics, can easily lead to failures at the operational level through equipment failure, unavailability of tools and equipment, additional stress on personnel, poor resourcing, etc.
- Environmental issues beyond anyone's control can add to any risk, e.g. weather, sea state. Poor ergonomics will become even more difficult to manage.

Mitigation of poor ergonomics

Ship owners and operators should:

- proactively consider effective ergonomic principles when commissioning ships, equipment or designing work procedures – user-centred design principles;
- proactively consider modifying ships, equipment and work processes to become more user centred;
- actively encourage ships and their crews to report ergonomic issues on board;

- ensure that procedures and work instructions are presented in a consistent format, easily understood by everyone who uses them; and
- ensure that those making use of procedures and work instructions are actively involved in their development and review.

Design and construction

Well-designed, user-centred equipment and work processes will support seafarers in their work and have a positive effect, reducing fatigue and stress and making work more satisfying, efficient and safe.

Procedural/work instruction ergonomics

Procedures need to be technically accurate and, equally important, well written, usable and up to date. Procedures need to:

- reflect how tasks are actually carried out;
- be accurate and complete;
- be clear and concise with an appropriate level of detail;
- be current and up to date;
- be supported by training (where appropriate);
- identify hazards;
- state necessary precautions for hazards;
- promote ownership by seafarers;
- use familiar language and be easily understood by everyone on board;
- take into account potential differences in language ability;
- use consistent terminology;
- be in a suitable format; and
- be accessible by all on board.

Organisation

- Organisational policies and practices should ideally support the front line in all its needs, i.e. set people up to succeed.
- Recruitment and selection practices should ensure that all personnel serving on board are fully competent for the duties they are to perform, including operating all equipment found on board. On-board familiarisation training should be immediate and effective.

- Practices for care, maintenance, supplies, etc. should ensure that vessels are always fully and correctly maintained and have ready access to all the stores, tools and supplies needed wherever they are in the world.

For more information, see 'HSG48 Reducing error and influencing behaviour' on the HSE website.

APPENDIX 1

REGULATIONS, MARINE NOTICES AND GUIDANCE ISSUED BY THE MARITIME AND COASTGUARD AGENCY

This lists all the regulations, marine notices and other guidance referred to in this Code.

Statutory instruments (regulations) are available on www.legislation.co.uk

TSO publications are available from TSO, PO Box 29, Norwich, NR3 1GN; www.tsoshop.co.uk

Copies of Maritime and Coastguard Agency (MCA) marine notices and forms can be downloaded from www.gov.uk/government/organisations/maritime-and-coastguard-agency

There are three different types of marine notice:

Merchant Shipping Notice (MSN),
Marine Guidance Note (MGN) and
Marine Information Note (MIN).

These notices publicise to the shipping and fishing industries important safety, pollution prevention and other relevant information.

Merchant shipping notices are used to convey mandatory information that must be complied with under UK legislation. These MSNs relate to statutory instruments and contain the technical detail of such regulations.

Marine guidance notes give significant advice and guidance relating to the improvement of the safety of shipping and of life at sea, and to prevent or minimise pollution from shipping.

Marine information notes are intended for a more limited audience e.g. training establishments or equipment manufacturers, or contain information which will only be of use for a short period of time, such as timetables for MCA examinations. MINs are numbered in sequence and have a cancellation date (which will typically be no more than twelve months after publication).

Within each series of marine notices suffixes are used to indicate whether documents relate to merchant ships or fishing vessels, or to both. The suffixes following the number are:

(M) for merchant ships

(F) for fishing vessels

(M+F) for both merchant ships and fishing vessels.

Copies of MCA published leaflets are available from EC Group, Europa Park, Grays, Essex, RM20 4DN; email: mca@ecgroup.uk.com

The Code reference is shown in **bold** and the information is arranged in chapter order.

CHAPTER 1: MANAGING OCCUPATIONAL HEALTH AND SAFETY

Regulations:

1.1 S.I. 1997/2962 The Merchant Shipping and Fishing Vessels (Health and Safety at Work) Regulations 1997 (as amended).

Marine notices:

1.2.5

MSN 1838(M) Maritime Labour Convention, 2006: Minimum age.
MGN 522(M+F) Merchant Shipping and Fishing Vessels (Health and Safety at Work) Regulations 1997 and Merchant Shipping (Maritime Labour Convention) (Medical Certification) Regulations 2010; New and Expectant Mothers.

1.2.8 MGN 484(M) Maritime Labour Convention, 2006: Health and safety published accident statistics – information and advice.

Guidance:

1.2.3 *Leading for Safety: A practical guide for leaders in the maritime industry*: www.gov.uk/government/uploads/system/uploads/attachment_data/file/288220/leading_for_safety-9.pdf

CHAPTER 2: SAFETY INDUCTION

Regulations:

2.2.1 S.I. 1999/2722 The Merchant Shipping (Musters, Training and Decision Support Systems) Regulations 1999.

2.6.1 S.I. 2008/3257 The Merchant Shipping (Prevention of Pollution by Sewage and Garbage from Ships) Regulations 2008.

Marine notices:

2.2.1 MGN 71(M) Musters, drills, on-board training and instructions, and decision support systems.

2.6.1 MSN 1807(M+F) The Merchant Shipping (Prevention of Pollution by Sewage and Garbage from Ships) Regulations 2008.

CHAPTER 3: LIVING ON BOARD

Regulations:

None

Marine notices:

3.2.1; 3.4.1 MSN 1839(M) Maritime Labour Convention, 2006: Medical Certification Seafarer Medical Examination System and Medical and Eyesight Standards: Application of the Merchant Shipping (Maritime Labour Convention) Regulations 2010.

3.2.1 MSN 1815(M) Countries whose seafarer medical certificates are accepted as equivalent to the UK seafarer medical certificate (ENG1) from 1 July 2007.

3.5 MGN 399(M) Prevention of infectious disease at sea by immunisations and anti-malaria medication (prophylaxis).

3.6.4 MGN 505(M) Human element guidance – Part 1 Fatigue and fitness for duty: Statutory duties, causes of fatigue and guidance on good practice.

Guidance:

3.2.4 Maritime and Coastguard Agency (MCA), 'Your health at sea 8: Fit for purpose'.

3.2.7 MCA, *The Ship Captain's Medical Guide* (published by TSO).

CHAPTER 4: EMERGENCY DRILLS AND PROCEDURES

Regulations:

4.1.1; 4.4.9 S.I. 1999/2722 The Merchant Shipping (Musters, Training and Decision Support Systems) Regulations 1999.

4.2.8 S.I. 1998/2514 The Merchant Shipping (Passenger Ship Construction: Ships of Classes I, II, and II(A)) Regulations 1998.

Marine notices:

4.1.1

MGN 71(M) Musters, drills, on-board training and instructions, and decision support systems.

MSN 1579(M) Minimum training requirements for personnel nominated to assist passengers in emergency situations.

4.4.10 MGN 560(M) Life-saving appliances – Lifeboats, rescue boats, launching appliances, winches and on-load release gear – Operational and test procedures.

CHAPTER 5: FIRE PRECAUTIONS

None

CHAPTER 6: SECURITY ON BOARD

None

CHAPTER 7: HEALTH SURVEILLANCE

Regulations:

7.1.1 S.I. 1997/2962 The Merchant Shipping and Fishing Vessels (Health and Safety at Work) Regulations 1997 (as amended).

7.3.1

S.I. 2007/3100 The Merchant Shipping and Fishing Vessels (Health and Safety at Work) (Carcinogens and Mutagens) Regulations 2007.

S.I. 2007/3075 The Merchant Shipping and Fishing Vessels (Control of Noise at Work) Regulations 2007.

S.I. 2007/3077 The Merchant Shipping and Fishing Vessels (Control of Vibration at Work) Regulations 2007.

S.I. 2010/323 The Merchant Shipping and Fishing Vessels (Health and Safety at Work) (Biological Agents) Regulations 2010.

S.I. 2010/330 The Merchant Shipping and Fishing Vessels (Health and Safety at Work) (Chemical Agents) (as amended) Regulations 2010.

S.I. 2010/332 The Merchant Shipping and Fishing Vessels (Health and Safety at Work) (Work at Height) Regulations 2010.

S.I. 2010/2984 The Merchant Shipping and Fishing Vessels (Health and Safety at Work) (Asbestos) (as amended) Regulations 2010.

S.I. 2010/2987 The Merchant Shipping and Fishing Vessels (Health and Safety at Work) (Artificial Optical Radiation) Regulations 2010.

7.8.1

S.I. 1997/2962 The Merchant Shipping and Fishing Vessels (Health and Safety at Work) (as amended) Regulations 1997.

S.I. 2014/1616 The Merchant Shipping (Maritime Labour Convention) (Health and Safety) (Amendment) Regulations 2014.

Marine notices:

7.3.2 MGN 409(M+F) The Merchant Shipping and Fishing Vessels (Health and Safety at Work) (Chemical Agents) Regulations 2010.

7.7.3 MGN 408(M+F) The Merchant Shipping and Fishing Vessels (Health and Safety at Work) (Biological Agents) Regulations 2010.

7.8.1 MSN 1850(M) Maritime Labour Convention, 2006: Health and Safety Reporting of Occupational Diseases.

Forms:

7.8.2 MSF 4159 Occupational disease report form for UK registered merchant ships.

CHAPTER 8: PERSONAL PROTECTIVE EQUIPMENT

Regulations:

8.1.1; 8.2 S.I. 1999/2205 The Merchant Shipping and Fishing Vessels (Personal Protective Equipment) Regulations 1999.

8.6.1 S.I. 2007/3075 The Merchant Shipping and Fishing Vessels (Control of Noise at Work) Regulations 2007.

Marine notices:

8.1.1; 8.2.4 MSN 1870(M+F) The Merchant Shipping and Fishing Vessels (Personal Protective Equipment) Regulations 1999.

8.6.1 MGN 352(M+F) The Merchant Shipping and Fishing Vessels (Control of Noise at Work) Regulations 2007.

Guidance:

8.6.1 Maritime and Coastguard Agency (MCA) (2009) *Code of Practice for Controlling Risks due to Noise on Ships*, London: TSO (ISBN 978-0-11-553075-3).

CHAPTER 9: SAFETY SIGNS AND THEIR USE**Regulations:**

9.1.1 S.I. 2001/3444 The Merchant Shipping and Fishing Vessels (Safety Signs and Signals) Regulations 2001.

Marine notices:

9.1.1; Annex 9.1 MGN 556(M+F) The Merchant Shipping and Fishing Vessels (Safety Signs and Signals) Regulations 2001.

9.4.9 MSN 1676(M) The Merchant Shipping (Life-saving Appliances for Ships other than Ships of Classes III to VI(A)) Regulations 1999 and The Merchant Shipping (Life-saving Appliances for Passenger Ships of Classes III to VI(A)) Regulations 1999.

9.9.1 MSN 1665(M) The Merchant Shipping (Fire Protection) Regulations 1998: Fire-fighting equipment.

CHAPTER 10: MANUAL HANDLING**Regulations:**

10.3 S.I. 1998/2857 The Merchant Shipping and Fishing Vessels (Manual Handling Operations) Regulations 1998.

Marine notices:

10.3 MGN 90(M+F) Implementation of EC Directive 90/269/EC Merchant Shipping and Fishing Vessels (Manual Handling Operations) Regulations 1998.

CHAPTER 11: SAFE MOVEMENT ON BOARD SHIP**Regulations:**

11.1.1; 11.13 S.I. 1997/2962 The Merchant Shipping and Fishing Vessels (Health and Safety at Work) (as amended) Regulations 1997.

11.2.3 S.I. 2001/3444 The Merchant Shipping and Fishing Vessels (Safety Signs and Signals) Regulations 2001.

11.10.1 S.I. 1988/1638 The Merchant Shipping (Entry into Dangerous Spaces) Regulations 1998.

Marine notices:

11.1 MGN 532(M) Safe movement on board ship.

11.2.3 MGN 556(M+F) The Merchant Shipping and Fishing Vessels (Safety Signs and Signals) Regulations 2001.

11.7 MGN 35(M+F) Accidents when using power operated watertight doors.

Annex 11.2

MSN 1844(M) Maritime Labour Convention, 2006: Crew Accommodation.

MGN 481(M) Maritime Labour Convention, 2006: Crew Accommodation, Supplementary Guidance.

CHAPTER 12: NOISE, VIBRATION AND OTHER PHYSICAL AGENTS

Regulations:

12.5.1 S.I. 2007/3075 The Merchant Shipping and Fishing Vessels (Control of Noise at Work) Regulations 2007.

12.10 S.I. 2007/3077 The Merchant Shipping and Fishing Vessels (Control of Vibration at Work) Regulations 2007.

12.18 S.I. 2010/2987 The Merchant Shipping and Fishing Vessels (Health and Safety at Work) (Artificial Optical Radiation) Regulations 2010.

Marine notices:

12.5.1; Annex 12.2 MGN 352(M+F) The Merchant Shipping and Fishing Vessels (Control of Noise at Work) Regulations 2007.

12.9.1 MGN 377(M+F) Sound advice – noise at work from music and entertainment.

12.10 MGN 353(M+F) The Merchant Shipping and Fishing Vessels (Control of Vibration at Work) Regulations 2007.

12.15.3 MGN 436(M+F) Whole-body vibration: Guidance on mitigating against the effects of shocks and impacts on small vessels.

12.18 MGN 428 (M+F) The Merchant Shipping and Fishing Vessels (Health and Safety at Work) (Artificial Optical Radiation) Regulations 2010.

Guidance:

12.8.5 Maritime and Coastguard Agency (MCA) (2009) *Code of Practice for Controlling Risks due to Noise on Ships*, London: TSO (ISBN 978-0-11-553075-3).

12.14.8 MCA (2009) *Code of Practice for Controlling Risks due to Hand-transmitted Vibration on Ships*, London: TSO (ISBN 978-0-11-553090-6).

12.15.4 MCA (2009) *Code of Practice for Controlling Risks due to Whole-body Vibration in Ships*, London: TSO (ISBN 978-0-11-553076-0).

CHAPTER 13: SAFETY OFFICIALS

Regulations:

13.1; 13.2; 13.3; 13.4; 13.8 S.I. 1997/2962 The Merchant Shipping and Fishing Vessels (Health and Safety at Work) (as amended) Regulations 1997.

13.3.7.1; 13.3.8.4; 13.8.1 S.I. 2012/1743 The Merchant Shipping (Accident Reporting and Investigation) Regulations 2012.

Marine notices:

13.8.2 MGN 458(M+F) Accident reporting and investigation.

CHAPTER 14: PERMIT TO WORK SYSTEMS

None

CHAPTER 15: ENTERING DANGEROUS (ENCLOSED) SPACES

Regulations:

S.I. 1988/1638 The Merchant Shipping (Entry into Dangerous Spaces) Regulations 1988.

CHAPTER 16: HATCH COVERS AND ACCESS LIDS

None

CHAPTER 17: WORK AT HEIGHT

Regulations:

17.1.1. S.I. 2010/332 The Merchant Shipping and Fishing Vessels (Health and Safety at Work) (Work at Height) Regulations 2010.

17.2.4 S.I. 2006/2183 The Merchant Shipping (Provision and Use of Work Equipment) Regulations 2006.

Marine notices:

17.1.1; 17.3.1; 17.4.1; 17.5.1; 17.7.1; Annex 17.1 MGN 410(M+F)
The Merchant Shipping and Fishing Vessels (Health and Safety at Work) (Work at Height) Regulations 2010.

17.4.11 MGN 422(M) Use of equipment to undertake work over the side on yachts and other vessels.

CHAPTER 18: PROVISION, CARE AND USE OF WORK EQUIPMENT

Regulations:

18.1.2 S.I. 2006/2183 The Merchant Shipping and Fishing Vessels (Provision and Use of Work Equipment) Regulations 2006.

Marine notices:

18.1.2 MGN 331(M+F) The Merchant Shipping and Fishing Vessels (Provision and Use of Work Equipment) Regulations 2006.

18.1.9 MSN 1870(M+F) The Merchant Shipping and Fishing Vessels (Personal Protective Equipment) Regulations 1999.

18.19 MGN 556(M+F) The Merchant Shipping and Fishing Vessels (Safety Signs and Signals) Regulations 2001.

18.35.1 MSN 1838(M) Maritime Labour Convention, 2006: Minimum age.

CHAPTER 19: LIFTING PLANT AND OPERATIONS

Regulations:

19.1.1 S.I. 2006/2184 The Merchant Shipping and Fishing Vessels (Lifting Operations and Lifting Equipment) Regulations 2006.

Marine notices:

19.1.1; 19.20.5 MGN 332(M+F) The Merchant Shipping and Fishing Vessels (Lifting Operations and Lifting Equipment) Regulations 2006.

19.1.2 MGN 331(M+F) The Merchant Shipping and Fishing Vessels (Provision and Use of Work Equipment) Regulations 2006.

CHAPTER 20: WORK ON MACHINERY AND POWER SYSTEMS**Regulations:**

20.3.1 S.I. 2006/2183 The Merchant Shipping and Fishing Vessels (Provision and Use of Work Equipment) Regulations 2006.

20.3.6 S.I. 1996/2154 The Merchant Shipping (Prevention of Oil Pollution) Regulations 1996 (as amended)

Marine notices:

20.3.1 MGN 331(M+F) The Merchant Shipping and Fishing Vessels (Provision and Use of Work Equipment) Regulations 2006.

20.15 MGN 452(M) Electrical – potential hazards of arc flash associated with high and low voltage equipment.

CHAPTER 21: HAZARDOUS SUBSTANCES AND MIXTURES**Regulations:**

21.2.1 S.I. 2007/3100 The Merchant Shipping and Fishing Vessels (Health and Safety at Work) (Carcinogens and Mutagens) Regulations 2007.

21.4.1 S.I. 2010/2984 The Merchant Shipping and Fishing Vessels (Health and Safety at Work) (Asbestos) (as amended) Regulations 2010.

21.5.1 S.I. 2010/330 The Merchant Shipping and Fishing Vessels (Health and Safety at Work) (Chemical Agents) (as amended) Regulations 2010.

21.7.1 S.I. 1999/336 The Merchant Shipping (Carriage of Cargoes) Regulations 1999.

21.8.1 S.I. 2010/323 The Merchant Shipping and Fishing Vessels (Health and Safety at Work) (Biological Agents) Regulations 2010.

Marine notices:

21.2.1 MGN 356(M+F) The Merchant Shipping and Fishing Vessels (Health and Safety at Work) (Carcinogens and Mutagens) Regulations 2007.

21.4.1

MGN 429(M+F) The Merchant Shipping and Fishing Vessels (Health and Safety at Work) (Asbestos) Regulations 2010.

MGN 493(M+F) The Merchant Shipping and Fishing Vessels (Health and Safety at Work) (Asbestos) Regulations 2010 as amended by The Merchant Shipping and Fishing Vessels (Health and Safety at Work) (Asbestos) (Amendment) Regulations 2013.

21.5.1

MGN 409(M+F) The Merchant Shipping and Fishing Vessels (Health and Safety at Work) (Chemical Agents) Regulations 2010.

MGN 454(M+F) The Merchant Shipping and Fishing Vessels (Health and Safety at Work) (Chemical Agents) (Amendment) Regulations 2012.

21.7.1 MSN 1718(M) The safe use of pesticides in ships.

21.8.1 MGN 408(M+F) The Merchant Shipping and Fishing Vessels (Health and Safety at Work) (Biological Agents) Regulations 2010.

CHAPTER 22: BOARDING ARRANGEMENTS

Regulations:

22.1.1; 22.4.1 S.I. 1997/2962 The Merchant Shipping and Fishing Vessels (Health and Safety at Work) (as amended) Regulations 1997.

22.8.6; 22.9.1; Annex 22.1 S.I. 2002/1473 The Merchant Shipping (Safety of Navigation) Regulations 2002.

Marine notices:

22.9.1; Annex 22.1 MSN 1734(M+F) Approval of marine equipment (EC notified bodies) and MSN 1734(M+F) Approval of marine equipment (EC notified bodies) Amendment 8.

22.9.5 MGN 301(M+F) Manoeuvring information on board ships.

CHAPTER 23: FOOD PREPARATION AND HANDLING IN THE CATERING DEPARTMENT

Regulations:

23.1.19 S.I. 2008/3257 The Merchant Shipping (Prevention of Pollution by Sewage and Garbage from Ships) Regulations 2008.

Marine notices:

23.1.1 MSN 1845(M) Maritime Labour Convention, 2006: Food and catering: Provision of food and fresh water.

23.1.19 MSN 1807(M+F) The Merchant Shipping (Prevention of Pollution by Sewage and Garbage from Ships) Regulations 2008 – S.I. 2008 No. 3257.

23.4.3 MGN 312(F) Use of liquid petroleum gas (LPG) and diesel fuelled appliances on fishing vessels.

CHAPTER 24: HOT WORK

None

CHAPTER 25: PAINTING

None

CHAPTER 26: ANCHORING, MOORING AND TOWING OPERATIONS

Regulations: None

Marine notices:

26.5.9 MGN 308(M+F) Mooring, towing or hauling equipment on all vessels: Safe installation and safe operation.

CHAPTER 27: ROLL-ON/ROLL-OFF FERRIES

Regulations:

27.3.1

S.I. 1998/1011 The Merchant Shipping (Fire Protection: Small Ships) Regulations 1998.

S.I. 1998/1012 The Merchant Shipping (Fire Protection: Large Ships) Regulations 1998.

Marine notices:

27.2.2; 27.8.2; 27.12.1 MGN 341(M) Ro-ro ships' vehicle decks: Accidents to personnel, passenger access and the carriage of motor vehicles.

27.11.4 MGN 59(M) Special requirements for the transport of heated liquids and powdery or granulated materials in portable tanks.

27.12.1

MGN 545 Guidance on the transport of dangerous goods as defined by the International Maritime Dangerous Goods (IMDG) Code when carried in a private vehicle not in commercial use or by a foot passenger on a Ro-Ro ship.

MGN 552 Cargo – safe stowage of specialised vehicles.

Guidance:

27.5.1 Maritime and Coastguard Agency (MCA) (2009) *Code of Practice for Controlling Risks due to Noise on Ships*, London: TSO (ISBN 978-0-11-553075-3).

27.6.2 MCA (2003) *Code of Practice on the Stowage and Securing of Vehicles on Roll-on/Roll-off Ships*, London: TSO: www.gov.uk/government/uploads/system/uploads/attachment_data/file/292367/ro-ro_stowage_securing_of_vehicles_cop.pdf

CHAPTER 28: DRY CARGO

Regulations:

28.1.4 S.I. 1999/336 The Merchant Shipping (Carriage of Cargoes) Regulations 1999.

28.1.6 S.I. 1998/2241 The Merchant Shipping (Load Line) Regulations 1998.

28.2 S.I. 1997/2367 The Merchant Shipping (Dangerous Goods and Marine Pollutants) Regulations 1997.

Marine notices:

28.1.4 MGN 107(M) The Merchant Shipping (Carriage of Cargoes) Regulations 1999.

28.2 MGN 340(M) International Maritime Dangerous Goods (IMDG) Code and cargoes carried in cargo transport units.

28.2.5 MSN 1706(M) The carriage of military and commercial explosives – amendment no. 1.

28.2.7 MSN 1870(M+F) The Merchant Shipping and Fishing Vessels (Personal Protective Equipment) Regulations 1999.

28.4 MGN 157(M) Safety of personnel during container-securing operations and while working at corrugated bulkheads in general cargo ships.

CHAPTER 29: TANKERS AND OTHER SHIPS CARRYING BULK LIQUID CARGOES

Regulations:

29.1.1 S.I. 2015/782 The Merchant Shipping (Standards of Training, Certification and Watchkeeping) Regulations 2015.

29.1.10 S.I. 1988/1638 The Merchant Shipping (Entry into Dangerous Spaces) Regulations 1988.

29.2.3 S.I. 1998/1561 The Merchant Shipping (International Safety Management (ISM) Code) Regulations 1998.

29.3.1 S.I. 1994/2464 The Merchant Shipping (Gas Carriers) Regulations 1994.

29.4.4 S.I. 1996/3010 The Merchant Shipping (Dangerous or Noxious Liquid Substances in Bulk) Regulations 1996.

Marine notices:

29.1.1 MSN 1866(M) Seafarer training and certification guidance: Special training requirements for personnel on tankers and passenger ships.

CHAPTER 30: PORT TOWAGE INDUSTRY

Regulations: None

Marine notices:

30.8.1 MGN 199(M) Dangers of interaction.

CHAPTER 31: SHIPS SERVING OFFSHORE OIL AND GAS INSTALLATIONS

None

CHAPTER 32: SHIPS SERVING OFFSHORE RENEWABLES INSTALLATIONS

Regulations:

32.1.3 S.I. 2002/1587 The Merchant Shipping (Diving Safety) Regulations 2002

32.2.1 S.I. 2015/51 The Construction (Design and Management) Regulations 2015

32.4.2

S.I. 2005/735 Work at Height Regulations 2005

S.I. 2007/114 Work at Height (Amendment) Regulations 2007

Marine notices:

32.1.2 MGN 372(M+F) Guidance to Mariners Operating in the Vicinity of UK OREIs

32.1.3 MSN 1762(M+F) The Merchant Shipping (Diving Safety) Regulations 2002

32.5.1 MGN 497(M+F) Storage and use of dangerous goods onboard ship

32.7.1 MGN 280(M) Small Vessels in Commercial Use for Sport or Pleasure, Workboats and Pilot Boats – Alternative Construction Standards

CHAPTER 33: ERGONOMICS

None

Blank page

APPENDIX 2

OTHER SOURCES OF INFORMATION

This appendix lists the sources of the documents referred to in this Code.

International Maritime Organization (IMO) publications are available from IMO Publishing, 4 Albert Embankment, London, SE1 7SR, email sales@imo.org or telephone +44 (0)20 7735 7611.

The Code reference is shown in **bold** and the information is arranged in chapter order.

CHAPTER 1: MANAGING OCCUPATIONAL HEALTH AND SAFETY

References:

National Health Service (NHS) choices, Mental health:

www.nhs.uk/Livewell/MentalHealth/Pages/Mentalhealthhome.aspx

NHS choices, Stress, anxiety and depression:

www.nhs.uk/conditions/stress-anxiety-depression/Pages/low-mood-stress-anxiety.aspx

NHS choices, Tiredness and fatigue:

www.nhs.uk/livewell/tiredness-and-fatigue/Pages/tiredness-and-fatigue.aspx

1.2.1 *Code of Conduct for the Merchant Navy:*

<https://www.ukchamberofshipping.com/library/>

1.2.7 National Maritime Occupational Health and Safety Committee (NMOHSC), *Guidelines to Shipping Companies on Behavioural Safety Systems:*

<https://www.ukchamberofshipping.com/library/>

CHAPTER 2: SAFETY INDUCTION

References:

2.1.1

International Maritime Organization (IMO), International Convention on Standards of Training, Certification and Watchkeeping (STCW) for Seafarers, 1978, as amended: www.imo.org/en/OurWork/HumanElement/TrainingCertification/Pages/STCW-Convention.aspx

International Labour Organization (ILO), Maritime Labour Convention, 2006: www.ilo.org/global/standards/maritime-labour-convention/lang-en/index.htm

CHAPTER 3: LIVING ON BOARD

References:

National Health Service (NHS) Choices, Mental health:

www.nhs.uk/Livewell/MentalHealth/Pages/Mentalhealthhome.aspx

NHS Choices, Stress, anxiety and depression:

www.nhs.uk/conditions/stress-anxiety-depression/Pages/low-mood-stress-anxiety.aspx

3.2.4 National Health Service (NHS) Choices, 'Healthy eating':

www.nhs.uk/livewell/healthy-eating/Pages/Healthyeating.aspx

3.3.2 NHS Choices, 'Stop smoking':

www.nhs.uk/livewell/smoking/Pages/stopsmokingnewhome.aspx

3.6 International Maritime Organization (IMO), MSC/Circ.813 The role of human element, list of human element common terms:

www.imo.org/en/OurWork/HumanElement/VisionPrinciplesGoals/Documents/1014.pdf

NHS Choices, Tiredness and fatigue:

www.nhs.uk/livewell/tiredness-and-fatigue/Pages/tiredness-and-fatigue.aspx

3.7.2 Health and Safety Executive (HSE), 'Thermal comfort':

www.hse.gov.uk/temperature/thermal

3.8.1 York University, Canada, 'Guidelines for working in cold weather':

www.yorku.ca/dohs/documents/WorkingInColdWeather.pdf

3.8.3 NHS Choices, 'Frostbite':

www.nhs.uk/conditions/frostbite/Pages/Introduction.aspx

3.8.3 NHS Choices, 'Hypothermia':

www.nhs.uk/conditions/Hypothermia/Pages/Introduction.aspx

CHAPTER 4: EMERGENCY DRILLS AND PROCEDURES

References:

4.6.1; 4.7.4 National Maritime Occupational Health and Safety Committee (NMOHSC), *Man Overboard! Guidelines to shipping companies on procedures in cases of man overboard:*

<https://www.ukchamberofshipping.com/library/>

4.6.1 *Bridge Procedures Guide*, International Chamber of Shipping (ICS):

www.ics-shipping.org

4.11.2 International Maritime Dangerous Goods (IMDG) Code.

4.11.2 Emergency Procedures for Ships Carrying Dangerous Goods (EmS Guide).

CHAPTER 5: FIRE PRECAUTIONS

5.5.4 International Maritime Organization (IMO), MSC.1/Circ.1321

Guidelines for Measures to Prevent Fires in Engine Rooms and Cargo Pump Rooms:

www.imo.org/blast/blastDataHelper.asp?data_id=25964&filename=1321.pdf

CHAPTER 6: SECURITY ON BOARD

References:

6.2.1 International Maritime Organization (IMO), The International Ship and Port Facility Security (ISPS) Code:

www.imo.org/en/ourwork/security/guide_to_maritime_security/pages/solas-xi-2%20isps%20code.aspx

6.2.1 EC 725/2004: eur-lex.europa.eu/homepage.html

CHAPTER 7: HEALTH SURVEILLANCE

References:

National Health Service (NHS) Choices, Mental health:

www.nhs.uk/Livewell/MentalHealth/Pages/Mentalhealthhome.aspx

NHS Choices, Stress, anxiety and depression:

www.nhs.uk/conditions/stress-anxiety-depression/Pages/low-mood-stress-anxiety.aspx

NHS Choices, Tiredness and fatigue:

www.nhs.uk/livewell/tiredness-and-fatigue/Pages/tiredness-and-fatigue.aspx

7.4.3 Health and Safety Executive (HSE), 'Record keeping':

www.hse.gov.uk/health-surveillance/record-keeping/index.htm

7.6.1 HSE, 'Manage performance and act on results':

www.hse.gov.uk/health-surveillance/manage-performance.htm

CHAPTER 8: PERSONAL PROTECTIVE EQUIPMENT

None

CHAPTER 9: SAFETY SIGNS AND THEIR USE

References:

9.4.6 International Maritime Organization (IMO) Resolution A.654(16)

Graphical Symbols for Fire Control Plans: [www.imo.org/blast/blastDataHelper.asp?data_id=22396&filename=A654\(16\).pdf](http://www.imo.org/blast/blastDataHelper.asp?data_id=22396&filename=A654(16).pdf)

9.4.9 IMO Resolution A.760(18) Symbols Relating to Life-saving Appliances and Arrangements: [www.imo.org/blast/blastDataHelper.asp?data_id=22605&filename=A760\(18\)E.pdf](http://www.imo.org/blast/blastDataHelper.asp?data_id=22605&filename=A760(18)E.pdf)

9.5.2 IMO Resolution A.1021(26) Code on Alerts and Indicators, 2009: [www.imo.org/blast/blastDataHelper.asp?data_id=29981&filename=A1021\(26\).pdf](http://www.imo.org/blast/blastDataHelper.asp?data_id=29981&filename=A1021(26).pdf)

9.5.4 IMO Resolution A.918(22) Standard Marine Communication Phrases, 2002 (IMO SMCP 2001) (IMO sales no. IA987E) and *IMO SMCP on CD-ROM 2004, Standard Marine Communication Phrases: A pronunciation guide*, London: IMO (IMO sales no. D987E): [www.imo.org/blast/blastDataHelper.asp?data_id=24571&filename=A918\(22\).pdf](http://www.imo.org/blast/blastDataHelper.asp?data_id=24571&filename=A918(22).pdf)

CHAPTER 10: MANUAL HANDLING

None

CHAPTER 11: SAFE MOVEMENT ON BOARD SHIP

References:

Annex 11.2 Convention on the International Regulations for Preventing Collisions at Sea (COLREG), 1972 (as amended): www.imo.org/en/About/Conventions/ListOfConventions/Pages/COLREG.aspx

CHAPTER 12: NOISE, VIBRATION AND OTHER PHYSICAL AGENTS

References:

12.12.6 Health and Safety Executive (HSE), 'Vibration at work': www.hse.gov.uk/vibration

12.16.2 HSE, 'Providing health surveillance' (hand–arm vibration): www.hse.gov.uk/vibration/hav/advicetoemployers/healthsurveillance.htm

12.16.3 HSE, 'Health monitoring and review' (whole-body vibration): www.hse.gov.uk/msd/wbv.htm

12.18 *Non-binding guide to good practice for implementing Directive 2006/25/EC Artificial Optical Radiation:*

http://bookshop.europa.eu/is-bin/INTERSHOP.enfinity/WFS/EU-Bookshop-Site/en_GB/-/EUR/ViewPublication-Start?PublicationKey=KE3010384

Non-binding guide to good practice for implementing Directive 2013/35/EU Electromagnetic Fields:

<http://bookshop.europa.eu/en/non-binding-guide-to-good-practice-for-implementing-directive-2013-35-eu-electromagnetic-fields-pbKE0415140/>

CHAPTER 13: SAFETY OFFICIALS

References

13.3.8.4 Marine Accident Investigation Branch (MAIB): www.gov.uk/government/organisations/marine-accident-investigation-branch

CHAPTER 14: PERMIT TO WORK SYSTEMS

None

CHAPTER 15: ENTERING DANGEROUS (ENCLOSED) SPACES

References:

15.1; 15.2; 15.6.11 International Maritime Organization (IMO) Resolution A.1050(27) Revised Recommendations for Entering Enclosed Spaces Aboard Ships:

www.imo.org/en/KnowledgeCentre/IndexofIMOResolutions/Documents/A%20-%20Assembly/1050%2827%29.pdf

15.6.2 MSC.1 Circ 1477 'Guidelines to facilitate the selection of portable atmosphere testing instruments for enclosed spaces as required by SOLAS Regulation XI-1/7'

15.6.11 Health and Safety Executive (HSE), 'EH40/2005 Workplace exposure limits': www.hse.gov.uk/pubns/books/eh40.htm

CHAPTER 16: HATCH COVERS AND ACCESS LIDS

None

CHAPTER 17: WORK AT HEIGHT

References:

Annex 17.1 Health and Safety Executive (HSE), 'Advice for first-aiders responding to harness suspension incidents': www.hse.gov.uk/firstaid/whats-new/harness.htm

CHAPTER 18: PROVISION, CARE AND USE OF WORK EQUIPMENT

None

CHAPTER 19: LIFTING PLANT AND OPERATIONS

References:

19.21.4 Health and Safety Executive (HSE), *INDG339 Thorough examination and testing of lifts: Simple guidance for lift owners*: www.hse.gov.uk/pubns/indg339.pdf

CHAPTER 20: WORK ON MACHINERY AND POWER SYSTEMS

References:

- 20.3.2** International Maritime Organization (IMO), International Convention for the Safety of Life at Sea, 1974 (SOLAS) II-2 Reg 4.2.2.6 Construction fire-protection, fire detection and fire extinction: Arrangements for oil fuel, lubrication oil and other flammable oils; Protection of high temperature surfaces: [www.imo.org/en/About/Conventions/ListOfConventions/Pages/International-Convention-for-the-Safety-of-Life-at-Sea-\(SOLAS\),-1974.aspx](http://www.imo.org/en/About/Conventions/ListOfConventions/Pages/International-Convention-for-the-Safety-of-Life-at-Sea-(SOLAS),-1974.aspx)
- 20.3.4** IMO Resolution A.1021 (26) Code on Alerts and Indicators, 2009: [www.imo.org/blast/blastDataHelper.asp?data_id=29981&filename=A1021\(26\).pdf](http://www.imo.org/blast/blastDataHelper.asp?data_id=29981&filename=A1021(26).pdf)
- 20.3.13** IMO, MSC.1/Circ.1321- Guidelines for Measures to Prevent Fires in Engine Rooms and Cargo Pump Rooms: www.imo.org/blast/blastDataHelper.asp?data_id=25964&filename=1321.pdf
- 20.3.14** IMO, MSC/Circ.834 Guidelines for Engine-Room Layout, Design and Arrangement: http://www.imo.org/blast/blastDataHelper.asp?data_id=8819
- 20.15.3** National Institutes of Health (NIH), 2010, description of second-degree burns: www.nlm.nih.gov/medlineplus/ency/article/000030.htm

CHAPTER 21: HAZARDOUS SUBSTANCES AND MIXTURES

References:

- 21.1.10** Control of Substances Hazardous to Health (COSHH) Regulations: www.hse.gov.uk/coshh/index.htm
- 21.3.4** Health and Safety Executive (HSE), EH40/2005 *Workplace exposure limits*: www.hse.gov.uk/pubns/books/eh40.htm

21.5.2 European Regulation (EC) 1272/2008 Classification, Labelling and Packaging of Substances and Mixtures (CLP Regulation):

eur-lex.europa.eu/LexUriServ/LexUriServ.do

?uri=OJ:L:2008:353:0001:1355:en:PDF

21.7.2

International Maritime Organization (IMO) MSC.1/Circ.1264

Recommendations on the Safe Use of Pesticides in Ships Applicable to the Fumigation of Cargo Holds:

www.imo.org/blast/blastDataHelper.asp?data_id=22225&filename=1264.pdf

IMO MSC.1/Circ.1358 Recommendations on the Safe Use of Pesticides in Ships:

www.imo.org/blast/blastDataHelper.asp?data_id=29809&filename=1358.pdf

21.7.4 HSE, HSG251 *Fumigation: Health and safety guidance for employers and technicians carrying out fumigation operations:*

www.hse.gov.uk/pubns/books/hsg251.htm

CHAPTER 22: BOARDING ARRANGEMENTS

References:

22.2.3; 22.7.1; Annex 22.1 International Maritime Organization (IMO) MSC.1/Circ.1331 Guidelines for Construction, Installation, Maintenance and Inspection/Survey of Means of Embarkation and Disembarkation:

www.imo.org/blast/blastDataHelper.asp?data_id=25973&filename=1331.pdf

22.7.1 SOLAS II.1/3-9 Construction – Structure, subdivision and stability, machinery and electrical installations: Means of embarkation on and disembarkation from ships.

22.9.1; Annex 22.1, 5 IMO, SOLAS V.23 Safety of navigation: Pilot transfer arrangements:

[www.imo.org/en/About/Conventions/ListOfConventions/Pages/International-Convention-for-the-Safety-of-Life-at-Sea-\(SOLAS\),-1974.aspx](http://www.imo.org/en/About/Conventions/ListOfConventions/Pages/International-Convention-for-the-Safety-of-Life-at-Sea-(SOLAS),-1974.aspx)

22.9.1 IMO Resolution A.1045(27) Pilot Transfer Arrangements: [www.imo.org/en/KnowledgeCentre/IndexofIMOResolutions/Documents/A%20-%20Assembly/1045\(27\).pdf](http://www.imo.org/en/KnowledgeCentre/IndexofIMOResolutions/Documents/A%20-%20Assembly/1045(27).pdf)

22.10 International Maritime Pilots' Association, 'Required boarding arrangements for pilots':

www.impahq.org/admin/resources/finalimpapladderposter.pdf

22.11 UK Port Skills and Safety, 'SIP021 Guidance to safe access to fishing vessels and small craft in ports':

<https://www.portskillsandsafety.co.uk/sites/default/files/2017-05/SIP021%20-%20Guidance%20on%20safe%20access%20to%20fishing%20vessels%20and%20small%20craft%20in%20ports%20-%2023%20Nov%202016.pdf>

Annex 22.1, 3.1 SOLAS III/3.13 Life-saving appliances and arrangements: Definitions.

CHAPTER 23: FOOD PREPARATION AND HANDLING IN THE CATERING DEPARTMENT

None

CHAPTER 24: HOT WORK

References:

24.10 Health and Safety Executive (HSE), HSG139 *The safe use of compressed gases in welding, flame cutting and allied processes*: www.hse.gov.uk/pubns/books/hsg139.htm

CHAPTER 25: PAINTING

None

CHAPTER 26: ANCHORING, MOORING AND TOWING OPERATIONS

None

CHAPTER 27: ROLL-ON/ROLL-OFF FERRIES

References:

27.12.3 Department for Environment, Food and Rural Affairs (Defra), *Welfare of Animals During Transport: New rules for transporting animals*: www.gov.uk/government/publications/welfare-of-animals-during-transport--2

CHAPTER 28: DRY CARGO

References:

28.1.4 International Maritime Organization (IMO) Resolution A.714(17) Code of Safe Practice for Cargo Stowage and Securing: [www.imo.org/blast/blastDataHelper.asp?data_id=22526&filename=A714\(17\).pdf](http://www.imo.org/blast/blastDataHelper.asp?data_id=22526&filename=A714(17).pdf)

28.2.5 IMO MSC/Circ.857 The Medical First Aid Guide for Use in Accidents Involving Dangerous Goods (MFAG): www.imo.org/en/OurWork/Safety/Cargoes/DangerousGoods/Pages/MFAG.aspx

28.3.1 UK Port Skills and Safety, 'SIP008 Guidance on the storage of dry bulk cargo': www.portskillsandsafety.co.uk/sites/default/files/documents/sip008_-_the_storage_of_dry_bulk_cargo_guidance_-_issue_1.pdf

28.4

IMO, MSC/Circ.886 Recommendation on Safety of Personnel During Container-Securing Operations: <http://www.sjofartsverket.se/upload/7156/886.pdf>

IMO, MSC/Circ.888 Preventing Falls at Corrugated Bulkheads in General Cargo Ships: <http://imo.udhb.gov.tr/dosyam/EKLER/MSC-Circ.888.pdf>

CHAPTER 29: TANKERS AND OTHER SHIPS CARRYING BULK LIQUID CARGOES

References:

29.1.2; 29.3.1; 29.4.5 International Chamber of Shipping, *Tanker Safety Guide (Chemicals)* and *Tanker Safety Guide (Liquefied Gas)*:

www.ics-shipping.org/publications/safety-and-operations

29.1.3 International Maritime Organization (IMO) MSC/Circ.1025 Carriage of Dangerous Goods, International Maritime Dangerous Good (IMDG) Code, Annexes and Supplements, Revised Emergency Response Procedures for Ships Carrying Dangerous Goods (EmS Guide): www.imo.org/blast/blastDataHelper.asp?data_id=15039&filename=1025.pdf

29.1.3 IMO MSC/Circ.857 The Medical First Aid Guide for Use in Accidents Involving Dangerous Goods (MFAG): www.imo.org/en/OurWork/Safety/Cargoes/DangerousGoods/Pages/MFAG.aspx

29.2.3 *International Safety Guide for Oil Tankers and Terminals* (ISGOTT).

CHAPTER 30: PORT TOWAGE INDUSTRY

None

CHAPTER 31: SHIPS SERVING OFFSHORE OIL AND GAS INSTALLATIONS

References:

IMCA Guidance: *Guidance on the Transfer of Offshore Personnel to and from Offshore Vessels and Structures*: IMCA SEL 025 Rev 1, IMCA M 202 Rev 1:

www.imca-int.com

31.6.1; 31.8; 31.9.8; 31.11.1; 31.15; 31.16.1 Guidelines for Offshore Marine Operations (G-OMO): www.g-omo.info

CHAPTER 32: SHIPS SERVING OFFSHORE RENEWABLES INSTALLATIONS

32.4.5 IMCA Guidance: *Guidance on the Transfer of Offshore Personnel to and from Offshore Vessels and Structures* – IMCA SEL 025 Rev 1, IMCA M 202 Rev 1:

www.imca-int.com

32.5.1 *The Workboat Code, Industry Working Group Technical Standard*: www.gov.uk/government/uploads/system/uploads/attachment_data/file/527971/The_Workboat_Code.pdf

National Workboat Association – *Good Practice Guide for Offshore Vessels*:

www.workboatassociation.org/news/nwa-publishes-good-practice-guide-for-offshore-energy-service-vessels/

32.6.1

Integrated Offshore Emergency Response – Renewables (IOER-R): Good Practice Guidelines for Offshore Renewable Energy Developments:

http://c.ymcdn.com/sites/www.renewableuk.com/resource/collection/ae19eca8-5b2b-4ab5-96c7-ecf3f0462f75/IOER-R_report_2016.PDF?hhSearchTerms=%22integrated+and+response%22
www.renewableuk.com/page/HealthSafety

32.7.1

G9 Offshore Wind Health and Safety Association, *Good Practice Guideline: The safe management of small service vessels used in the offshore wind industry:*

<http://publishing.energyinst.org/topics/power-generation/offshore-wind/good-practice-guideline-the-safe-management-of-small-service-vessels-used-in-the-offshore-wind-industry>

Health and Safety strategy for renewables:

www.renewableuk.com/page/HealthSafety

The National Workboat Association *Good Practice Guide for Offshore Energy Service Vessels:*

www.workboatassociation.org/news/nwa-publishes-good-practice-guide-for-offshore-energy-service-vessels

Emergency rescue cooperation planning:

www.gov.uk/government/publications/offshore-renewable-energy-installations-orei

CHAPTER 33: ERGONOMICS**References:**

33.2.6 Health and Safety Executive (HSE), 'INDG36 Working with display screen equipment (DSE)': www.hse.gov.uk/pubns/indg36.pdf

Blank page

APPENDIX 3

STANDARDS AND SPECIFICATIONS REFERRED TO IN THIS CODE

NOTE: Copies of standards produced by the British Standards Institution (BSI) can be obtained from BSI Customer Services, 389 Chiswick High Road, London W4 4AL; or online from shop.bsigroup.com

Standards double pre-fixed 'BS EN' are the UK version in English of a European harmonised standard. The prefix 'BS EN ISO' appears where an international standard has been adopted by Europe as a European Standard.

All standards are subject to periodic updating, the most recent version should be used.

Copies of EU Directives are available from:
eur-lex.europa.eu/homepage.html?locale=en

The Code reference is shown in **bold**.

Information arranged in chapter order

CHAPTER 1: MANAGING OCCUPATIONAL HEALTH AND SAFETY

None

CHAPTER 2: SAFETY INDUCTION

None

CHAPTER 3: LIVING ON BOARD

3.13

BS EN ISO 12311:2013 Personal protective equipment – Test methods for sunglasses and related eyewear.

BS EN ISO 12312-1:2013+A1:2015 Eye and face protection – Sunglasses and related eyewear. Part 1: Sunglasses for general use.

3.14 BS EN ISO 23907:2012 Sharps injury protection – Requirements and test methods – Sharps containers.

CHAPTER 4: EMERGENCY DRILLS AND PROCEDURES

None

CHAPTER 5: FIRE PRECAUTIONS

None

CHAPTER 6: SECURITY ON BOARD

None

CHAPTER 7: HEALTH SURVEILLANCE

None

CHAPTER 8: PERSONAL PROTECTIVE EQUIPMENT

None

CHAPTER 9: SAFETY SIGNS AND THEIR USE

9.7.1 BS EN 1089-3:2011 Transportable gas cylinders. Gas cylinder identification (excluding LPG). Colour coding.

9.7.3 BS EN ISO 407:2004 Small medical gas cylinders. Pin-index yoke-type valve connections.

9.8.1

BS ISO 14726:2008 Ships and marine technology – identification colours for the content of piping systems.

BS 4800:2011 Schedule of paint colours for building purposes.

9.9.1 BS EN 3-10:2009 Portable fire extinguishers. Provisions for evaluating the conformity of a portable fire extinguisher to EN 3-7.

9.9.4

BS 7863:2009 Recommendations for colour coding to indicate the extinguishing media contained in portable fire extinguishers.

BS 5423:1987 (*withdrawn*) Specification for portable fire extinguishers.

CHAPTER 10: MANUAL HANDLING

None

CHAPTER 11: SAFE MOVEMENT ON BOARD SHIP

None

CHAPTER 12: NOISE, VIBRATION AND OTHER PHYSICAL AGENTS

None

CHAPTER 13: SAFETY OFFICIALS

None

CHAPTER 14: PERMIT TO WORK SYSTEMS

None

CHAPTER 15: ENTERING DANGEROUS (ENCLOSED) SPACES

15.13.3

EN 137:2006 Respiratory protective devices. Self-contained open-circuit compressed air breathing apparatus with full face mask. Requirements, testing, marking.

BS EN 14593-1:2005 Respiratory protective devices. Compressed air line breathing apparatus with demand valve. Apparatus with a full mask. Requirements, testing, marking.

BS EN 14593-2:2005 Respiratory protective devices. Compressed air line breathing apparatus with demand valve. Apparatus with a half mask at positive pressure. Requirements, testing, marking.

BS EN 14594:2005 Respiratory protective devices. Continuous flow compressed air line breathing apparatus. Requirements, testing, marking.

BS EN 1146:2005 Respiratory protective devices. Self-contained open-circuit compressed air breathing apparatus incorporating a hood for escape. Requirements, testing, marking.

CHAPTER 16: HATCH COVERS AND ACCESS LIDS

None

CHAPTER 17: WORK AT HEIGHT

None

CHAPTER 18: PROVISION, CARE AND USE OF WORK EQUIPMENT

None

CHAPTER 19: LIFTING PLANT AND OPERATIONS

None

CHAPTER 20: WORK ON MACHINERY AND POWER SYSTEMS

None

CHAPTER 21: HAZARDOUS SUBSTANCES AND MIXTURES

None

CHAPTER 22: BOARDING ARRANGEMENTS

22.9.1; Annex 22.1, 4.2 BS ISO 799:2004 Ships and marine technology – pilot ladders.

Annex 22.1, 1.1

BS MA 89:1980 Specification for accommodation ladders.

ISO 5488:1979 Shipbuilding – accommodation ladders.

ISO 7061:1993 Shipbuilding – aluminium shore gangways for seagoing vessels.

Annex 22.1, 2.1 BS MA 78:1978 Specification for aluminium shore gangways.

Annex 22.1, 3.2 ISO 7364:1983 Shipbuilding and marine structures – Deck machinery – Accommodation ladder winches.

Annex 22.1, 3.3 BS MA 39-2:1973 (*withdrawn*) Specification for ships' ladders. Ladders, steel sloping.

Annex 22.1, 4.2 Marine Equipment Directive (MED) (EC Directive 96/98/EC 20 Dec 1996).

CHAPTER 23: FOOD PREPARATION AND HANDLING IN THE CATERING DEPARTMENT

None

CHAPTER 24: HOT WORK

24.4.1

BS EN ISO 11611:2007 Protective clothing for use in welding and allied processes.

BS EN 169:2002 Personal eye-protection. Filters for welding and related techniques. Transmittance requirements and recommended use.

24.6.8 EN 60529:1992+A2:2013 Degrees of protection provided by enclosures (IP code).

24.7.1 BS 7193:1989 (*withdrawn*) Specification for lined lightweight rubber overshoes and overboots.

24.9.14, Annex 24.3 EN 1256:2006 Gas welding equipment. Specification for hose assemblies for equipment for welding, cutting and allied processes.

Annex 24.2 BS EN 60974-1:2012 Arc welding equipment. Welding power sources.

Annex 24.3

BS EN ISO 3821:2010 Gas welding equipment. Rubber hoses for welding, cutting and other allied processes.

BS 3212:1991 Specification for flexible rubber tubing, rubber hose and rubber hose assemblies for use in LPG vapour phase and LPG/air installations.

ISO/TR 28821:2012 Gas welding equipment – Hose connections for equipment for welding, cutting and allied processes – Listing of connections which are either standardised or in common use.

BS EN 561:2002 Gas welding equipment. Quick-action coupling with shut-off valves for welding, cutting and allied processes.

ISO 7289:2010 Gas welding equipment. Quick-action couplings with shut-off valves for welding, cutting and allied processes.

CHAPTER 25: PAINTING

None

CHAPTER 26: ANCHORING, MOORING AND TOWING OPERATIONS

None

CHAPTER 27: ROLL-ON/ROLL-OFF FERRIES

None

CHAPTER 28: DRY CARGO

None

CHAPTER 29: TANKERS AND OTHER SHIPS CARRYING BULK LIQUID CARGOES

None

CHAPTER 30: PORT TOWAGE INDUSTRY

None

CHAPTER 31: SHIPS SERVING OFFSHORE OIL AND GAS INSTALLATIONS

None

CHAPTER 32: SHIPS SERVING OFFSHORE RENEWABLES INSTALLATIONS

None

CHAPTER 33: ERGONOMICS

None

Information arranged by Standards number

British Standards (BS)/European Norm (EN)/International Organization Standardization (ISO)

BS EN ISO Standards number	BS/EN/ISO full title	Code reference
BS EN ISO 407:2004	Small medical gas cylinders. Pin-index yoke-type valve connections	9.7.3
BS EN ISO 3821:2010	Gas welding equipment. Rubber hoses for welding, cutting and other allied processes	Annex 24.3
BS EN ISO 11611:2007	Protective clothing for use in welding and allied processes	24.4.1
BS EN ISO 12311:2013	Personal protective equipment – Test methods for sunglasses and related eyewear	3.13
BS EN ISO 12312-1:2013+A1:2015	Eye and face protection – Sunglasses and related eyewear. Part 1: Sunglasses for general use	3.13
BS EN ISO 23907:2012	Sharps injury protection – Requirements and test methods – Sharps containers	3.14

British Standards

BS number	BS full title	Code reference
BS MA 39-2:1973 (<i>withdrawn</i>)	Specifications for ships' ladders. Ladders, steel sloping	Annex 22.1, 3.3
BS MA 78:1978	Specification for aluminium shore gangways	Annex 22.1, 2.1
BS MA 89:1980	Specification for accommodation ladders	Annex 22.1, 1.1
BS 3212:1991	Specification for flexible rubber tubing, rubber hose and rubber hose assemblies for use in LPG vapour phase and LPG/air installations	Annex 24.3
BS 4800:2011	Schedule of paint colours for building purposes	9.8.1
BS 5423:1987 (<i>withdrawn</i>)	Specification for portable fire extinguishers	9.9.4
BS 7193:1989 (<i>withdrawn</i>)	Specification for lined lightweight rubber overshoes and overboots	24.7.1
BS 7863:2009	Recommendations for colour coding to indicate the extinguishing media contained in portable fire extinguishers	9.9.4

BS/EN

BS/EN number	BS/EN full title	Code reference
BS EN 3-10:2009	Portable fire extinguishers. Provisions for evaluating the conformity of a portable fire extinguisher to EN 3-7	9.9.1
BS EN 169:2002	Personal eye-protection. Filters for welding and related techniques. Transmittance requirements and recommended use	24.3.2
BS EN 561:2002	Gas welding equipment. Quick-action coupling with shut-off valves for welding, cutting and allied processes	Annex 24.3
BS EN 1089-3:2011	Transportable gas cylinders. Gas cylinder identification (excluding LPG). Colour coding	9.7.1
BS EN 1146:2005	Respiratory protective devices. Self-contained open-circuit compressed air breathing apparatus incorporating a hood for escape. Requirements, testing, marking	15.13.3
BS EN 14593-1:2005	Respiratory protective devices. Compressed air line breathing apparatus with demand valve. Apparatus with a full mask. Requirements, testing, marking	15.13.3
BS EN 14593-2:2005	Respiratory protective devices. Compressed air line breathing apparatus with demand valve. Apparatus with a half mask at positive pressure. Requirements, testing, marking	15.13.3
BS EN 14594:2005	Respiratory protective devices. Continuous flow compressed air line breathing apparatus. Requirements, testing, marking	15.13.3
BS EN 60974-1:2012	Arc welding equipment. Welding power sources	Annex 24.2

BS/ISO Standards

BS/ISO Standard	BS/ISO full title	Code reference
BS ISO 799:2004	Ships and marine technology – pilot ladders	22.9.1; Annex 22.1, 4.2
BS ISO 14726:2008	Ships and marine technology – identification colours for the content of piping systems	9.8.1

EN Standards

EN number	EN full title	Code reference
EN 137:2006	Respiratory protective devices. Self-contained open-circuit compressed air breathing apparatus with full face mask. Requirements, testing, marking	15.13.3
EN 1256:2006	Gas welding equipment. Specification for hose assemblies for equipment for welding, cutting and allied processes	24.9.14, Annex 24.3
EN 60529:1992 +A2:2013	Degrees of protection provided by enclosures (IP code)	24.6.8

ISO Standards

ISO number	ISO full title	Code reference
ISO 5488:1979	Shipbuilding – accommodation ladders	Annex 22.1, 1.1
ISO 7061:1993	Shipbuilding – aluminium shore gangways for seagoing vessels	Annex 22.1, 1.1
ISO 7289:2010	Gas welding equipment. Quick-action couplings with shut-off valves for welding, cutting and allied processes	Annex 24.3
ISO 7364:1983	Shipbuilding and marine structures – Deck machinery – Accommodation ladder winches	Annex 22.1, 3.2
ISO/TR 28821:2012	Gas welding equipment – Hose connections for equipment for welding, cutting and allied processes – Listing of connections which are either standardised or in common use	Annex 24.3

Other applicable standards: EC Directives

Directive number	Full title	Code reference
96/98/EC 20 Dec 1996	Marine Equipment Directive (MED)	Annex 22.1, 4.2

APPENDIX 4

ACKNOWLEDGEMENTS

The Maritime and Coastguard Agency (MCA) acknowledges the kind permission for the following sources of information and illustrations used in this Code.

Links to the information are provided in Appendix 2, Other sources of information.

The Code reference is shown in **bold** and the information is arranged in chapter order.

CHAPTER 1: MANAGING OCCUPATIONAL HEALTH AND SAFETY

1.2.8 Eddie Perkins, Knowledge management diagram.

Annex 1.1 John Blaikie, Simple change (management of change).

CHAPTER 2: SAFETY INDUCTION

None

CHAPTER 3: LIVING ON BOARD

3.2.4; 3.3.2; 3.8.3 National Health Service (NHS) Choices, 'Healthy eating'; 'Stop smoking'; 'Frostbite' and 'Hypothermia'.

3.7.2 Health and Safety Executive (HSE), 'Controlling thermal comfort'.

3.8.1 York University, Canada, 'Guidelines for working in cold weather'.

CHAPTER 4: EMERGENCY DRILLS AND PROCEDURES

None

CHAPTER 5: FIRE PRECAUTIONS

None

CHAPTER 6: SECURITY ON BOARD

None

CHAPTER 7: HEALTH SURVEILLANCE

7.4.1 Health and Safety Executive (HSE), The health surveillance cycle diagram.

CHAPTER 8: PERSONAL PROTECTIVE EQUIPMENT

None

CHAPTER 9: SAFETY SIGNS AND THEIR USE

None

CHAPTER 10: MANUAL HANDLING

Annex 10.1 Health and Safety Executive (HSE), Guideline weight diagram.

CHAPTER 11: SAFE MOVEMENT ON BOARD SHIP

None

CHAPTER 12: NOISE, VIBRATION AND OTHER PHYSICAL AGENTS

12.12.6; 12.16.2; 12.16.3 Health and Safety Executive (HSE), 'Vibration at work'; 'Providing health surveillance' (hand–arm vibration); and 'Health monitoring and review' (whole-body vibration).

CHAPTER 13: SAFETY OFFICIALS

None

CHAPTER 14: PERMIT TO WORK SYSTEMS

Annex 14.1 North Star Shipping, Permit to work (general).

CHAPTER 15: ENTERING DANGEROUS (ENCLOSED) SPACES

None

CHAPTER 16: HATCH COVERS AND ACCESS LIDS

None

CHAPTER 17: WORK AT HEIGHT

None

CHAPTER 18: PROVISION, CARE AND USE OF WORK EQUIPMENT

None

CHAPTER 19: LIFTING PLANT AND OPERATIONS

None

CHAPTER 20: WORK ON MACHINERY AND POWER SYSTEMS

None

CHAPTER 21: HAZARDOUS SUBSTANCES AND MIXTURES

None

CHAPTER 22: BOARDING ARRANGEMENTS

None

CHAPTER 23: FOOD PREPARATION AND HANDLING IN THE CATERING DEPARTMENT

None

CHAPTER 24: HOT WORK

None

CHAPTER 25: PAINTING

None

CHAPTER 26: ANCHORING, MOORING AND TOWING OPERATIONS

Annex 26.1 Swedish Accident Investigation Administration, Complex snap-back zone. Acknowledged as source of diagram of snap-back zones on the foredeck of a ship.

CHAPTER 27: ROLL-ON/ROLL-OFF FERRIES

None

CHAPTER 28: DRY CARGO

None

CHAPTER 29: TANKERS AND OTHER SHIPS CARRYING BULK LIQUID CARGOES

None

CHAPTER 30: PORT TOWAGE INDUSTRY

None

CHAPTER 31: SHIPS SERVING OFFSHORE OIL AND GAS INSTALLATIONS

None

CHAPTER 32: SHIPS SERVING OFFSHORE RENEWABLES

None

CHAPTER 33: ERGONOMICS

33.2.6 Health and Safety Executive (HSE), 'Working with display screen equipment (DSE)'.

Blank page

INDEX

References are shown by chapter, section and paragraph numbers.
The letter A before a chapter number indicates the annex at the end of the chapter.

- abandon ship drills 4.1.4, 4.2.2, 4.4
- abrasive wheels 18.24
- access
 - boarding arrangements 22.1.1–22.2.10
 - cargo stowage 28.1.5
 - container tops 28.3.5, 28.3.8–28.3.9
 - cranes 19.13.8
 - hold access A11.1
 - maintenance of equipment 22.7
 - offshore renewable energy installations (OREIs) 32.4
 - pilots 22.9
 - positioning of boarding equipment 22.5
 - standards 22.1, A22.1
 - see also* boarding arrangements
- access lids 16.1–16.7.2
- accident investigation 13.4.3, 13.8
 - interviews 13.8.4, 13.8.5–13.8.6
 - records 13.3.7, 13.8.10–13.8.12
 - statutory requirements 13.8.3
 - witness statements 13.8.7–13.8.8
 - see also* incident investigations
- accumulators 20.21.1
- acetylene 24.9.8, 24.9.9
 - batteries 20.16.18, 20.16.19, 20.17
- aerials 17.2.10, 20.20.7, 20.20.8
- aerosols 3.10.2
- air starting reservoirs 20.7.4
- airlines 8.8.9, 15.13.3, 15.13.4, 15.9.6
 - see also* breathing apparatus
- alarm signals 20.2.2, 20.3.4, 23.4.1
- alcohol 3.2.4, 3.4
 - industrial 29.4.6
- aluminium equipment 22.7.3, A22.2
- ammonia 20.17.6, 29.3.4
- anchoring operations 26.1.1–26.2.6
 - adverse weather 11.12.3
 - anchoring points 17.4.7

- offshore installations 31.16
- weighing anchor 26.2.1–26.2.6, 26.6
- aprons 8.4.3, 20.17, 23.1.8, 24.4.2
- armed robbery 6.7
- asbestos dust 21.4
- assembly stations 2.2.1, 4.1.3
- atmosphere testing 15.6, 15.9.2

- back pain 12.10.2, 12.15.2
- baggage transfer 22.8.7, 31.12.5, 31.14.5
- barrels 28.4.11, 18.34.6, 19.13.1
- batteries, storage 20.16
 - alkaline 20.18
 - contamination 20.16.18
 - lead acid 20.16
- beams 16.5.1–16.5.8
- bearings 18.2.3
- bench machines 18.23
- benzene 21.3.6, 15.4.6
- beryllia (beryllium oxide) 20.22.3–20.22.5
- bights 19.14.3, 19.14.4, 19.16.2, 26.3.10, 23.3.12, 26.5.6
- bilges 20.3.6, 20.3.9
- biological agents 7.7, 21.8, A21.1
- bleach 3.11, 21.5.5
- blowback 20.6.7
- blowpipes 24.9.19–24.9.20, A24.1
- boarding arrangements 22.1–22.10
 - accommodation ladders 22.5.1, 22.5.5, A22.1/1, A22.1/3, A22.1/4.8–A22.1/4.9
 - bulwark ladders 22.5.2, A22.1/3.3, A22.1/4.7
 - gangways 22.2.2, 22.2.8, 22.5.1–22.5.3, 22.7.5, A22.1/1, A22.1/2
 - maintenance of equipment for means of access 22.7
 - means of access standards A22.1
 - offshore installations 31.10.4
 - offshore renewable energy installations (OREIs) 32.4
 - pilot access A22.1/4.1–A22.1/4.9
 - pilot ladders 22.9.1, 22.9.4, 22.10, A22.1/4.1–A22.1/4.4, A22.1/4.9
 - portable ladders 22.6
 - positioning of boarding equipment 22.5
 - rope ladders 22.6, 22.4, 22.6.4–22.6.6, A22.1/4.1
 - safety nets 22.3
 - special circumstances 22.8
 - transfer of personnel 22.8.6, 32.4
- boathooks 31.9.4
- body protection 8.11

boiler maintenance 20.6.1–20.6.11
bollards 26.3.7, 26.3.11, 26.3.17, 26.5.5, 26.5.8
boots *see* footwear
bosun's chair 17.5.1–17.5.6
bow thrusters 17.6.3
brakes
 anchoring 26.2.1, 26.2.3–26.2.4
 asbestos dust 21.4.1, 21.4.2
 lifting equipment 19.18.5
 maintenance 18.2.3, 19.4.3
breathing apparatus 8.8.13–8.8.14
 dangerous goods 28.2.10
 dangerous (enclosed) spaces 4.9.3, 15.3.2, 15.8.3, 15.8.4,
 15.11.1–15.11.2, 15.13.1–15.13.10, 15.14.7
 emergency escape breathing devices (EEBD) 15.14.8
 fires 4.2.8, 4.3.7, 4.12.11
 leakages and spillages 4.12.3
 maintenance 15.13.9–15.13.10
 spray-painting 25.4.5
bulkheads 28.1.5, 28.6.3, 28.7
bulldog grips A18.2
bump caps 8.5.4
buoys *see* lifebuoys
burns 18.10
 accumulators 20.21.1
 arc-flash 20.15.3–20.15.4
 chemical burns 21.5.5, 29.3.4
 cold burns 29.3.2
 food preparation 23.1.5, 23.1.18, 23.2.1, 23.3.5, 23.3.7, 23.5.1
 gas cargo 29.3.2, 29.3.4
 radio equipment 20.21.1
 storage batteries 20.16.7, 20.16.11, 20.18.2
 valves 22.22.1

cables
 anchoring 26.2.5
 battery compartments 20.16.8
 electric 24.6.6–24.6.8
 electric colour coding 9.6.1–9.6.2
 electric high voltage 20.14.13
 extension 20.19.4
 refrigerated containers 28.3.10
 welding 24.6.3, 24.6.4, 24.6.7–24.6.8
cancer 21.2.1, 21.2.5
carbon dioxide 21.9.2

- solid 21.9
- carbon monoxide 27.3.3
- carcinogens 21.2
- cardice see carbon dioxide, solid
- cargoes
 - adverse weather conditions 11.12.3
 - asbestos 21.4.6
 - bulk operations 31.7
 - cargo gear overhauling 19.17
 - cargo-handling equipment A19.2
 - cargo-securing manual 28.1.4
 - containers 28.3
 - dangerous (enclosed) spaces 15.4.2–15.4.15, 15.5.5
 - dry 28.1.1–28.7.7
 - grain 15.4.2, 28.1.3
 - information provision 28.4.5
 - lifting 31.8.8–31.8.9
 - lighting in cargo spaces A11.2, 28.5
 - loading and unloading 28.1.4, 31.6.13
 - moveable bulkheads in cargo holds 28.7
 - offshore installations 31.6
 - offshore renewable energy installations (OREIs) 32.5
 - oxygen-absorbing 15.4.2
 - pesticides 21.7
 - precautions for personnel 28.6
 - securing of cargo 11.4.9, 27.1.4
 - stowage of cargo 28.1
 - timber 15.4.2, 28.1.7
 - toxic 15.4.4–15.4.13
 - volatile 15.4.2
 - working cargo 28.4
- casting off 26.3
- casualties 4.10.1, A17.1/2, A17.1/5, 31.16.7
- catering department
 - catering equipment 23.7
 - deep fat fryers 23.3, 23.5
 - galley stoves, steam boilers and deep fat fryers 23.3
 - health and hygiene 23.1
 - liquefied/liquid petroleum gas (LPG) appliances 23.4
 - microwave ovens 23.6
 - refrigerated rooms and storerooms 23.9
 - sharp implements 23.8
 - slips, falls and tripping hazards 23.2
- cathode ray tubes 20.22.2, 20.22.3
- caustic soda 3.11.1, 21.5.5

- chains 18.2.3, 19.4.3, 19.11.12, 19.20.4, 28.4.21
 - anchors 31.16.10–31.16.11
 - stoppers 19.16.2
- change management 1.2.4, A1.1
- chassis 20.19.1, 20.19.3, 20.21.2
- chemical agents 21.5
 - chemical carriers 29.4
 - chemical containers 29.4.4
 - chemical exposure 8.7.1
 - flammable chemicals 29.4.2
 - flammable vapours 15.4.15
 - labelling 3.11.3
 - solvents 3.11.5
 - toxic chemicals 15.6.12
- chisels 18.21.3
- choppers 23.8.3
- cigarettes, e-cigarettes 2.2.2, 5.2.1
 - see also* smoking
- circuit breakers 18.22.3, 18.22.5, 20.12.3
- clamps 19.11.15
- cleanliness
 - food preparation and handling 23.1.10–23.1.19
 - hydraulic and pneumatic equipment 20.11.3
 - personal 29.1.4
- closed circuit television (CCTV) 27.2.5
- clothing 3.9
 - anchoring 26.2.1
 - asbestos 21.4.5
 - cold climates 3.8.3
 - dangerous (enclosed) spaces 15.7.3
 - drying 3.12.12, 5.3.7
 - food preparation and handling 23.1.8
 - high-visibility clothing 8.11
 - hot climates 3.7.4, 3.7.6
 - hot spaces 24.4.2
 - insect bite protection 3.5.2
 - leakages and spillages 4.12.3
 - man overboard drills 4.6.8–4.6.9
 - manual handling 10.4.11
 - painting 25.2.6, 25.4.3
 - working clothes 3.11.5, 3.11.9, 12.14.7, 12.15.2, 18.1.9
 - see also* personal protective equipment
- cofferdams 15.4.15, 24.2.7
- cold chambers 21.9.1
- cold climates 3.8

- cold stores 23.9.6
- colour blindness 9.3.2
- colour-coding system 9.3.1
- communications
 - dangerous (enclosed) spaces 15.8.9, 21.9.2
 - lifts 19.21.10
 - occupational health and safety 1.2.2, 1.2.4, 1.2.5
 - offshore installations 30.5, 31.5, 31.10.6, 31.10.9, 31.12.6, 31.13.1
 - roll-on/roll-off ferries 27.6.3, 27.10.10
 - safe movement 11.12.7
 - safety induction 2.1
 - towing 30.7
 - tugs 30.7.2
- compactors 2.6.4
- Company duties
 - asbestos 21.4.3
 - boiler maintenance 20.6.4
 - dangerous (enclosed) spaces 11.10.3, 15.2.7
 - derricks 19.14.1
 - fatigue 3.6.3
 - hazardous substances and mixtures 21.1.5, 21.1.7
 - health and safety 2.7.1, 2.8, 13.1.1
 - hearing protection A12.3
 - lifting equipment 19.13.5
 - malaria 3.5.1
 - manual handling 10.3.1–10.3.4, A10.1
 - noise assessment 12.7.3, 31.4.4
 - offshore renewable energy installations (OREIs) 32.2.2
 - personal protective equipment 8.2.1, 8.2.3, 8.2.6
 - physical agents 12.1.4
 - risk assessment 12.1.2–12.1.3
 - safe movement 11.2.3
 - safety induction 2.1.2–2.2.3
 - safety officials 13.3
 - safety responsibilities 13.1.1, 29.2.3
 - safety signs 11.2.3
 - work equipment 12.11, 12.14.2–12.14.6, 18.1.3, 18.2.3
- compressed air 18.25.7–18.25.8, 31.7.2
- compressed gas cylinders 24.8
- confined spaces see dangerous (enclosed) spaces
- containers 28.3
 - fires 4.12.14
 - inspections 31.6.5
 - loading 31.6.7
 - refrigerated containers 28.3.10

- stowage 31.6.6
- corrosion 22.7.1, 22.7.3, A22.2
- counterbalance weights 19.2.6
- coxswain 31.10.4–31.10.5
- cradles and stages 8.5.3, 17.4.1–17.4.11
- craft, small 22.11, 26.6
 - safe access to 22.11.1–22.11.3
 - transfer by 31.10
- cranes 16.4.3, 19.2.3, 19.11.3, 19.11.18, 19.13
 - access 19.13.8
 - beams 16.5.4, 15.5.4
 - crane drivers 31.6.11
 - personnel carriers 31.11
 - stowage position 19.8.3
- crankcases 8.5.4, 20.8.2, 20.8.3, 20.8.4, 20.8.5
- crew accommodation regulations A11.2
- crockery 23.1.10, 23.1.17, 23.2.3
- cuts 2.4.1, 3.2.5, 3.12.5, 23.1.4

- danger zones A17.4/11, 18.8.3, 20.3.1, 26.3.13
- dangerous goods and substances 28.2
 - containers 28.3.2
 - emergency procedures 28.2.5
 - firefighting 4.12.14
 - jettisoning 4.12.14
 - leakages and spillages 4.12.2
 - offshore installations 31.6.4
 - package of 4.12.8–4.12.9
 - roll-on/roll-off ferries 27.11
- dangerous (enclosed) spaces 15.1–15.14.8
 - air supply 15.11.2–15.11.4, 15.14.6
 - boilers 20.6.5
 - breathing apparatus and resuscitation equipment 15.6.3, 15.13, 15.11.1–15.11.2, 15.13.1–15.13.10, 15.14.7
 - casualties 15.8.5–15.8.6, 15.14.2
 - clothing 15.7.3
 - communications 15.8.9, 21.9.2
 - Confined Spaces Regulations 1997 15.2.7
 - control systems 15.7
 - definition 15.1.1
 - drills 4.8, 15.14.1
 - duties and responsibilities of competent person and responsible officer 15.2
 - emergency preparation 15.14.1–15.14.2
 - emergency rescue arrangements 15.9.5, 15.14.2–15.14.8

- employer duties 15.12
- entry into 11.10, A14.1, 15.5
- equipment maintenance 15.9
- hot climates 3.7.3
- identifying potential hazards 15.4
- manufacturers' instructions for equipment 15.6.2
- oxygen deficiency 15.4.2
- painting 25.2.4
- permits to work A14.1.1, 15.1.4, 15.3.1, 15.7.1, 15.9.3, 15.10.1
- personal gas monitors 8.8.9–8.8.12, 15.6.5
- precautions before entering 15.3, 15.8.1
- preparing and securing for entry 15.5–15.8.9
- procedures and arrangements before entry 15.8
- procedures and arrangements during entry 15.9
- procedures on completion 15.10
- regulations 15.12
- tankers and bulk carriers 29.1.10
- testing atmosphere 15.2.1, 15.6, 21.9.2
- testing for flammable gases and vapours 15.6.8–15.6.10, 15.5.1
- testing for oxygen deficiency 15.6.6–15.6.7
- testing for toxic gases 15.4.7, 15.6.11–15.6.13
- toxicity of oil 15.4.4–15.4.6
- toxicity of other substances 15.4.7–15.4.18
- training, instruction and information 15.2.6, 15.12
- ventilation 15.1.7, 15.5.1, 15.9.1, 21.9.2
- welding 24.7.4
- davits 4.4.5, 4.4.13–4.4.14, 4.4.19, 19.2.3
- dead man alarms 20.4.6
- decision trees 1.2.6
- decks 11.3.1, 11.11, 26.3.6, 27.2.3, 31.6.12, 31.16.6–31.16.7
- deep fat fryers 23.5, 23.7
- dermatitis 3.2.5, 7.3.1, 7.3.2
- derricks 16.4.3, 16.5.4, 19.2.2, 19.2.3, 19.11.18, 19.14
 - union purchase 19.15, A19.1.2
- detergents 3.11.5
- diarrhoea and vomiting 23.1.7
- diesel engines 20.7.2–20.7.3, 20.7.5
- discharges 17.6.4
- display screen equipment (DSE) 33.2
- diving bells 15.1.5
- diving safety 32.1.3
- doors 18.22.1
 - crankcase explosion doors 20.7.3
 - fire doors 2.1.1
 - high-voltage mechanisms 20.14.6

- laundry equipment 18.35.5
- lift landings 19.21.9, 19.21.11
- manholes 20.6.1
- pilot access A22.1/4.6
- refrigerated rooms 23.9.1, 23.9.2, 23.9.3, 23.9.4
- trap doors A22.1/4.9
- watertight doors 4.2.9, 11.7, 11.13.2, 20.2.3, 30.2.2
- weathertight doors 2.1.1
- drain cocks 19.13.4
- drainage 11.3
- drikold see carbon dioxide, solid
- drills 4.1–4.12
 - abandon ship 4.1.4, 4.2.2, 4.4
 - dangerous (enclosed) spaces 4.8
 - fire 4.2
 - hot climates 3.7.3
 - leakage and spillage 4.11
 - lifeboat 4.1.5, 4.4.2
 - man overboard 4.6
 - ship security plan (SSP) 6.2.3
 - survival craft 4.1.3, 4.1.4, 4.1.15
- drive units 18.32
- drowning 8.12
- drug misuse 3.2.4
- drug smuggling 6.8
- drums 28.4.11
- dry cargo 28.1.1–28.7.7
 - carriage of containers 28.3
 - dangerous goods and substances 28.2
 - lighting in cargo spaces 28.5
 - loading and unloading 28.1.4
 - moveable bulkheads in cargo holds 28.7
 - precautions for personnel 28.6
 - stowage of cargo 28.1
 - working cargo 28.4
- dry-cleaning operations 21.6
- drying cabinets 5.3.8
- drying clothes 3.12.12, 5.3.8
- duck boards 11.3.4
- dust 3.11.6
 - asbestos dust 21.5
 - beryllia (beryllium) 20.22.5
 - dust masks 4.12.3
 - painting 25.2.1

- e-cigarettes 2.2.2, 5.2.1
- ear protection 20.3.4
 - ear muffs 8.6.4, A12.3
 - ear plugs 8.6.1, A12.3
 - see also hearing protection
- electric shock 3.12.7
 - batteries 20.16.12
 - power tools 18.22.2
 - precautions 11.5.8, 18.22.2, 20.7.1, 20.12.1–20.12.2, 20.12.6
 - treatment 20.12.1
 - welding equipment 24.7.5
- electrical equipment 18.9
 - earthing 24.6.4, 26.4.5
 - fire precautions 5.3
 - galleys 23.3.3
 - hazards 3.12.7, 3.12.11–3.12.13
 - maintenance 20.12
 - plug-in facilities 27.12.4
 - precautions during electric arc welding 24.7
 - tankers and bulk carriers 29.1.8
 - test meters 20.12.7
 - welding 24.6
- electrical high-voltage systems 20.14
 - arc-flash 20.15
 - busbars 20.14.16
 - cables 20.14.13
 - definitions 20.14.2
 - earthing 20.14.11
 - entry to enclosures containing high-voltage systems 20.14.10
 - failure of supply 20.14.9
 - insulation testing 20.14.8
 - locking off 20.14.6
 - maintenance 20.12.2
 - notices 20.14.12
 - permit to work A14.1, 20.14.13, 20.14.16
 - protective equipment 20.14.7
 - ring main units 20.14.15
 - sanction to test 14.3, A14.2
 - switchgear 20.14.4
 - transformers 20.14.14
 - withdrawn apparatus 20.14.5
 - work on 20.14.3
- electrical wiring 9.6
- electrodes 24.6.9–24.6.10, 24.7.7–24.7.10
- electrolyte 20.16.18–20.16.20, 20.17.1

- emergency drills and procedures 4.1–4.14
 - abandon ship drills 4.4–4.5
 - casualties 4.10
 - dangerous (enclosed) space drills 4.8, 4.9, 15.9.5, 15.14
 - fire drills 4.2
 - fires 4.3
 - leakage and spillage drills 4.11–4.12
 - man overboard drills 4.6–4.7
 - musters 4.1
 - offshore renewable energy installations (OREIs) 32.6
- emergency equipment 4.2.3, 28.2.5
 - see also* rescue equipment
- emergency escape routes 2.1.1, 11.13.2, 20.2.3
 - dangerous spaces 4.9, 15.9.5, 15.14.2–15.14.8
 - fire drills 20.2.3
 - working at height A17.1
- emergency response and rescue vessels (ERRVs) 31.1.2
- emergency stop controls 18.13
- employer duties
 - hazardous substances 21.1.5, 21.5.3, 21.5.7, 21.8.2
 - health and safety 1.1, 13.1.1, 13.2, 13.3.2.1, 13.3.8.1, 15.5.3
 - health surveillance 7.1.1, 7.2.1, 7.4.1, 7.6.1, 7.8.1, 12.8.1
 - occupational disease reporting 7.8.1
 - offshore renewable energy installations (OREIs) 32.2.2
 - personal protective equipment 8.2.6
 - safety committees 13.7.1
 - safety officials 13.2, 13.3.6.2, 13.3.6.3, 13.3.8.1, 13.5.3, 13.6.2
 - safety signs 11.2.3
- engine room 17.4.9, 20.3.7
- engines
 - cleaning 20.5.2
 - main engines 20.8
 - motor lifeboats 4.4.6
 - starting 20.7.2, 20.7.6, 20.8.2
- environmental responsibilities 2.6
- ergonomics 33.1.1–33.2.6, A33.1
 - challenges of poor ergonomics A33.1
 - design 33.1.1, A33.1
 - display screen equipment (DSE) 33.2
 - mitigation of poor ergonomics A33.1
 - organisation 31.1.1, A33.1
 - procedural/work instruction ergonomics A33.1
 - risks A33.1
 - work processes 31.1.1
- exhaust fans 20.9.3
- exhaust pipes 20.3.2

- explosions 4.12.2, 8.8.10, 24.2.3–24.2.10
- explosives 6.5.1
- exposure limits 12.4.1, 12.6.3, 12.11, 15.6.11, 21.3.4
- eye-bolts 19.11.20
- eye protection 3.12.3, 3.13, 8.7, 18.24.11, 20.20.3, 21.5.4, 21.5.5
- eye tests 33.2.3
- eyewash 29.3.4

- face protection 8.2, 15.14.7
- falls 8.10, 23.2, 28.1.8, 31.16.5
- fatigue (tiredness) 3.6
- fencing 28.1.8
- fingers
 - cold weather 3.8.2
 - food preparation 23.8.6, 23.8.8
 - hygiene 23.1.3
 - lifting loads 4.4.18
 - ‘white’ finger 18.22.11
- fire
 - action 4.3
 - causes of 2.2.3, 25.1–25.5.2
 - dangerous goods 4.12.14
 - fire drills 4.2
 - fire mains 4.2.2
 - safety induction 2.1.1
 - spontaneous combustion 5.4
 - fire doors 2.1.1
- fire extinguishers 2.2.1, 4.2.6, 4.2.7, 4.3.4
 - safety signs 9.9
- fire precautions 2.2.1–2.2.4, 5.1–5.6
 - electrical and other fittings 5.3
 - galleys 5.6
 - hot work 24.2.3–24.2.10
 - machinery spaces 5.5
 - roll-on/roll-off ferries 27.4
 - smoking 3.3, 5.2
 - spontaneous combustion 5.4
- fire pumps 4.2.1, 4.2.4
- firefighting
 - below deck 4.12.10
 - dangerous goods 4.12.14
 - equipment 4.2.4, 4.12.11, 4.12.13, 11.13.2
 - self-propelled work equipment 18.30.1
 - signs 9.4.6, 9.8.2
 - with water 4.12.7, 4.12.12

- first aid 2.1.1, 2.1.4, 28.2.5
- flame cutting 24.2.1, 24.2.3, 24.2.9, 24.3.1, 24.4.1, 24.5.1
- flammable coatings 20.7.4
- flammable liquids 4.12.1
- flammable substances 4.12.3
 - aerosols 3.10.2
 - leakages and spillages 4.12.1
 - storage 5.5.3
 - switchboards 20.12.5
- flammable vapours 15.4.14–15.4.15
 - hydraulic fluid 18.25.4, 20.11.6
- floor plates 20.2.5, 20.2.6
- floors, protection against heat 5.3.9
- flotation devices, personal 32.4.4
- foams, firefighting 4.3.4, 4.12.13
- food, frozen 21.9.1, 23.1.12, 23.6.1
- food preparation and handling 23.1–23.9
 - catering equipment 23.7.1–23.7.9
 - deep fat frying 23.5.1–23.5.9
 - galley stoves, steamboilers and deep fat fryers 23.3.1–23.3.8
 - health and hygiene 23.1.1–23.1.19
 - knives, saws, choppers 23.8.1–23.8.8
 - liquid petroleum gas appliances 23.4.1–23.4.5
 - microwave ovens 23.6.1–23.6.2
 - refrigerated rooms and store rooms 23.9.1–23.9.10
 - slips, falls and trips 23.2.1–23.2.7
- footwear 3.12.2, 8.9.2–8.9.3, 11.13.2
 - catering staff 23.2.1
 - manual handling 10.4.10
 - welding 24.7.1
- fork-lift trucks 18.28, 19.18.7
- fuel 20.3.6, 20.6.7
- fuel gases 24.9.1, 24.9.6, 24.9.11, A24.1
 - fuel gas cylinders 24.9.7, 24.9.16
- fuel injectors 20.7.5
- fuel lines 4.3.5
- fuel pumps 4.2.5
- fuel tanks 4.2.5
- fumes 20.20.6, 24.3.1
- fumigants 15.4.13, 21.7.4–21.7.6, 28.3.11, 28.6.5
- funnel 17.2.9

- galleys
 - clothing 3.9.1
 - cuts 3.12.5

- drainage 11.3.1
- fire precautions 2.2.3, 4.3.3, 4.3.5, 5.6
- galley stoves 23.3
- health and hygiene 23.1.1–23.1.19
- hosing down 23.3.3
- sharp implements 23.8
- waste 2.6.3
- gangways 22.2.2, 22.2.8, 22.5.3, 22.7.5, 22.11, A22.1/1–A22.1/2
 - corrosion A22.2
 - security 6.4.1
 - transfer of personnel 13.14
- gantlines 17.4.6, 17.5.1, 17.5.3
- gantries 17.4.9, 19.4.3
- garbage 11.4.7, 29.1.7
 - food waste 2.6.3
 - handling and storage of 2.6.2
 - spontaneous combustion 5.4.1
- gases
 - batteries 20.16.1
 - combustible gas indicators 15.6.13
 - dangerous (enclosed) spaces 15.1.1, 15.1.7, 15.3.3, 15.4.2, 15.4.9, 15.5.1, 29.1.10
 - flammable gases 15.4.18, 24.8.3
 - gas cylinders 9.7, 27.12
 - gas cylinders, compressed gas 24.8
 - gas cylinders, fuel gas 24.9.7, 24.9.16
 - gas detectors 23.4.1
 - gas testing/equipment 8.8.9–8.8.12, A14.1
 - gas welding and cutting 24.2.7, 24.9
 - hydrocarbon 15.4.4–15.4.5, 15.6.10, A24.3, 31.7.2
 - liquefied gas carriers 29.3
 - LPG appliances 23.4
 - refrigerants 23.9.6
 - toxic gases 27.3.3
 - toxic substances 15.1.3
- gauges 20.3.8, 20.6.9, 24.9.3
- gauntlets 24.4.1
- generators 12.6.8, 12.10.1, 20.7.1, 20.13.2, 20.6.2
- glass 2.6.3, 3.12.5, 23.1.10, 23.1.17, 23.2.3
- gloves 3.12.1, 8.9.1, 12.14.7, 21.9.2, 31.4.3
- goggles 3.12.3, 8.7.2, 9.4.8
- grain 15.4.2, 15.4.11, 28.1.3
- gratings 11.4.4, 23.2.2
- greasing 19.4.3
- guardrails 11.2.4, 11.6.2–11.6.4, 11.13.2

cradles 17.4.1
galley 23.3.4
guards *see* safety guards
guys 19.15.4–19.5.5

hair protection 8.5.5, 8.9.1, 18.1.9
hand signals 27.6.3
handgrips 16.5.2, 16.6.3
handrails 11.8.1, 23.2.5
hands
 disablement 18.22.11
 food preparation 23.1.3
 gauntlets 24.4.1
 gloves 8.9.1, 12.14.7, 31.4.3
hand–arm vibration 12.10.1, 12.14.1–12.14.8, 12.16.1–12.16.2
harm
 environmental harm 3.6.2
 health surveillance 7.2.1, 7.2.2
 likelihood of harm 1.2.5, A1.2
harmful substances 3.3.1, 3.11.5, 8.8.4–8.8.6, 23.1.18
harnesses 8.10.1
 boarding arrangements 22.9.3
 rescue harnesses 4.6.4, 15.8.3, 15.8.4, 15.8.6, 15.13.9, 16.7.2
 safety harnesses 4.6.4
 working at height/over the side 17.2.6, 17.2.14, 17.3.1
hatch covers 16.1–16.7.2
 emergency action 16.3.7
 instructions 16.3.1
 mechanical hatch covers 16.3
 non-mechanical hatch covers 16.4
 non-mechanical manually handled hatch covers 16.5
hatchways 11.6.1, 15.1.8, 28.1.10, 28.1.11
hawsers 3.12.2
hazardous substances and mixtures 3.11
 asbestos dust 21.4
 biological agents 21.8, A21.1
 carcinogens and mutagens 21.2, A21.1
 chemical agents 21.5
 dry-cleaning operations 21.6
 leakages and spillages 4.11–4.12
 pesticides 21.7
 prevention or control of exposure 21.3
 risk assessment 21.1.4, 21.2.1, 21.2.4, 21.4.5, 21.8.4
 safety data sheets 21.1.4
 see also dangerous goods and substances

- hazards A33.1
 - cargo 31.6.6, 31.6.7, 31.8.8
 - cargo spaces 28.6
 - dangerous (enclosed spaces) 15.1.3, 15.4
 - electrical 3.12.11–3.12.13
 - ergonomics A33.1
 - food preparation 23.2
 - fumigation 28.3.11
 - hazards to movement 11.4.5, 11.4.8
 - health surveillance 7.2.2
 - identification 1.2.5, A1.2, 15.4
 - lifts 19.11.10
 - noise 12.5.2
 - offshore renewable energy installations (OREIs) 32.3.3–32.3.4, 32.4.2
 - personal protective equipment 8.1.4
 - personnel transfers by specialist craft 31.10.3
 - permit to work systems 14.2, A14.1
 - punts 17.6.2
 - radio equipment 20.20.1–20.21.6
 - risk assessment 1.2.5
 - sharp implements 23.8
 - signs 9.4.7
 - towing 30.4.2, 30.8.2
 - tripping 11.13.2, A11.2, 31.16.5, 31.16.6
 - wires 31.16.12–31.16.13
 - work equipment 18.1.7–18.1.8
- head protection 3.7.4, 3.12.4, 8.5
- health and hygiene 2.4
 - food preparation and handling 23.1.1–23.1.19
 - hot climates 3.7.1
 - personal 2.4.1, 3.2.1–3.2.5
 - smoking 3.3.1–3.3.3
 - substances hazardous to health 3.11
- health and safety *see* occupational health and safety; safety induction
- health surveillance 7.1–7.8
 - actions 7.4
 - application 7.3
 - diving safety 32.1.3
 - employer duties 7.1, 7.4.1
 - exposure to biological agents 7.7
 - managing 7.6
 - noise 12.8
 - purpose 7.2
 - records 7.4.2–7.4.3
 - reporting occupational diseases 7.8

- seafarers 7.5
- seafarers' records 7.2.2, 7.4.2–7.4.3
- vibration 12.16
- hearing protection 8.6, 12.6.3–12.6.7, A12.3, 18.22.10
 - hearing checks 12.8.2
- heaters 3.12.12, 5.3.7, 5.3.9–5.3.11
- heaving lines 22.9.3, 26.3.5, 26.3.6, 26.5.5, 30.4.2, 31.9.4
- helmets 8.5.1–8.5.3, 31.4.3
- high-pressure jetting equipment 18.25
- hoists 28.4.18
 - rescue hoists 15.8.3, 15.8.7
- holds
 - access to holds 11.8.2, A11.1
 - dangerous (enclosed) spaces 15.1.5
 - fire drills 4.2.3
 - moveable bulkheads 28.7
 - rescuing casualties from 4.10.2
- hooks
 - bosun's chair 17.5.2
 - cargo hooks 19.14.1, 28.4.21
 - off-load/on-load release 4.4.12
 - towing hooks 30.3.1–30.3.2
 - working cargo 28.4.9, 28.4.11, 28.4.13
- hoses
 - bulk cargo operations 31.7.2
 - firefighting 4.2.4
 - pneumatic 18.22.6
 - spray-painting 25.4.9–25.4.10
 - welding 24.9.15–24.9.16
- hot climates 2.4.3
- hot surfaces 20.3.2, 23.3.5
- hot work A14.1, 24.1–24.10
 - compressed gas cylinders 24.8
 - earthing of arc welding systems A24.2
 - electric welding equipment 24.6
 - gas welding and cutting 24.2.7, 24.9
 - hoses and connections/assemblies A24.3
 - lighting up and shutting down procedures A24.1
 - personal protective equipment 24.4
 - pre-use equipment check 24.5
 - precautions against fire and explosion 24.2.3–24.2.10
 - precautions during electric arc welding 24.7
 - see *also* welding
- housekeeping 2.2.3, 2.5, 3.10, 3.14, 27.13
- hydraulic equipment
 - jacks 18.29

- jetting equipment 18.25
- maintenance 20.11
- roll-on/roll-off ferries 27.7.6
- hydraulic fluid 18.25.4, 20.11.6
- hydrogen sulphide 15.4.10–15.4.11
- hygiene *see* health and hygiene
- hypothermia 3.8.3

- ice, dry *see* carbon dioxide, solid
- ignition
 - batteries 20.16.1
 - e-cigarettes 2.2.2, 5.2.1
 - engines 20.8.5
 - furnaces 20.6.7
 - hoses A24.3
 - leakages and spillages 4.12.1, 24.9.16
 - re-ignition of fires 4.3.8
 - safety precautions 15.8.2, 24.2.3, 24.2.6, 24.8.3, 24.9.8, 29.1.7
 - spontaneous combustion 5.4.1, 5.4.2
 - vapours 29.2.1
- immersion suits 8.4.3, 32.4.4
- incident investigations 1.2.8
- incinerators 2.6.4
- inductions 1.2.1
- inertial clamp devices 8.10.2
- injuries
 - electrical equipment 3.12.11–3.12.13, 20.15.3–20.15.4
 - extreme temperatures 18.10.1–18.10.2
 - eye injuries 3.12.3, 3.13
 - fatigue and injury 3.6.2
 - hand injuries 3.12.1
 - foot injuries 3.12.2
 - frostbite/frostnip 3.8.3
 - head injuries 3.12.4
 - hypothermia 3.8.3
 - manual handling 10.2.1, 10.2.2
 - mooring 26.2.1
 - scalds 3.2.6
 - sharps 3.14
 - smoking 3.3.1
 - tool misuse 3.12.8
 - towing 26.5.1, 26.5.8
 - see also* burns; cuts
- inoculations 2.4.2, 3.4.2
- insect bites 3.5.2

- insecticidal sprays 3.10.3
- inspections
 - abandon ship drills 4.4.3
 - accident investigation 13.8.10
 - containers 31.6.5
 - driving permits 11.9.2
 - fire drills 2.2.4, 4.2.9
 - hatch covers 16.2.5, 16.3.1
 - health and safety 13.4.4
 - laundry equipment 18.35.3
 - lifting equipment 19.5
 - mooring equipment 26.3.7
 - musters and drills 4.1.7
 - personal protective equipment 8.2.9
 - safety inspections 13.4.1.1, 13.4.1.2 13.4.3.2, 13.4.4, 13.5.2, A13.1
 - roll-on/roll-off ferries 27.10.21
 - ropes 18.2.3
 - spillages 4.12.6
 - towing equipment 30.3
 - vehicles shipped by ro-ro ferries 27.8
 - work equipment 18.2.2, 18.3.1–18.3.7
- irons, hand-pressing 2.2.3, 2.12.13
- isolation measures 18.16

- jacks, hydraulic 18.29
- jetting equipment 18.25.6
- jewellery 18.1.9, 20.16.11

- knives 23.8
- knowledge management 1.2.8

- labelling 3.11.2, 3.11.3
- ladders 11.8.2–11.8.5, 11.13.2, A11.1, A17.2, 28.4.4
 - accommodation ladders 22.5.1, 22.5.5, 22.9.4, A22.1/1.1–A22.1/1.4, A22.1/3, A22.1/4.8–A22.1/4.9, A22.2
 - boarding ladders 26.4.2
 - bulwark ladders 22.5.2, A22.1/3.3, A22.1/4.7
 - fixed ladders 11.8.3, A11.1, 22.11
 - pilot ladders 22.9.1, 22.9.4, 22.10, A22.1/4.1–A22.1/4.4, A22.1/4.9
 - portable ladders 11.8.4–11.8.5, 17.3, A17.2/3–A17.2/4, 22.2.9, 22.6, 22.11, 28.6.4
 - rope ladders 22.6.4–22.6.6, A22.1/4.1
 - wooden ladders 17.3.3
- lamps 15.8.3
 - portable 18.22.4, 20.16.5, 27.10.9

- safety 20.5.10
- languages 1.2.5, 9.2, 18.6.4
- lanyards 17.2.14
- lashings
 - cargo on deck 11.12.3
 - containers 28.3.6, 28.3.8, 31.6.13–13.6.14
 - securing vehicles 27.9.10, 27.10.5, 27.10.11–27.10.20
- launches, mooring 26.6.1, A26.2
- laundries 11.3.1, 18.35
- leakages and spillages
 - dangerous (enclosed) spaces 15.4.8
 - dangerous goods 28.2.8, 28.2.9, 28.2.10
 - drills 4.11
 - machinery and power systems 20.3.5
 - tankers and bulk carriers 29.1.7
- lifesaving equipment 3.10.1, 4.1.4, 4.4.7, 4.4.13, 4.4.21
- lifeboats
 - abandon ship 4.5.3–4.5.4
 - drills 4.1.5, 4.4.2, 4.4.9
 - engines 4.4.6
 - stations 2.2.1, 4.1.4
 - winch 4.4.4
 - working overside 17.2.7
- lifebuoys 4.4.16, 8.12.1
 - boarding arrangements 22.2.10, 22.9.3, 22.10
 - deck working 31.16.7
 - mooring to buoys 24.6
 - offshore installations 31.9.4
 - working overside 17.2.6, 17.4.5
- lifejackets 4.1.5, 4.4.15, 4.6.7, 8.12.1, 26.4.1
 - adverse weather 11.12.5
 - transfer of personnel 31.9.3, 31.10.3, 31.10.10, 31.13.1
 - working at height 17.2.6
- lifelines 4.4.16, 11.4.3, 11.13.2, 15.8.3, 15.8.5–15.8.6
 - heavy weather 31.3.2, 31.16.6
 - offshore installations 31.3.2
 - working aloft/over the side 17.3.1, 17.4.5
- life rafts 4.4.2, 4.4.13, 4.4.20
- lifting
 - cargo 31.8.9
 - carrying 11.7.7
 - containers 28.3.4
 - putting down 10.2.1, 10.4.3
- lifting plant and operations 19.1–19.21, 28.4.2
 - accessories 19.2.9–19.2.11

cargo gear overhaul 19.17
carrying personnel 19.18.1, 19.18.2, 19.20
certificates 19.2.2, 19.6.1
 test and thorough examination of derricks used in union
 purchase A19.1.2
 test and thorough examination of lifting appliances A19.1.1
 test and thorough examination of loose gear A19.1.3
 test and thorough examination of wire rope A19.1.4
 testing and thorough examination of equipment A19.1
chains 19.4.3
code of hand signals A19.3
containers 19.8.7
controls 19.8
cranes 19.13
defect reporting and testing 19.19
derricks 19.14, 19.15
examination and inspection 19.5
hatches 16.4.4, 16.5.2
installation 19.10
jams 21.12.19
lifting equipment 19.2, 19.3, 19.6.1, 19.20
lifting operations 19.2.1
maintenance 19.4, 20
marking 19.7
offshore installations 31.6.13, 31.8.8, 31.11.1, 31.12.6–31.12.8
permits to work A14.1, 19.21.7
personnel lifting equipment 19.20, 28.3.8
positioning 19.10
powered appliances 19.9.1–19.9.2
proof loading 19.19.3
records 19.7
register of ships' lifting appliances and cargo-handling gear A19.2
reports 19.7
roll-on/roll-off ferries 27.7.5
ropes 19.4.3
safe movement 11.9.1, 11.9.4
safe working load (SWL) 19.12, 19.19.3
safety devices 19.2.8
safety measures 19.9
stoppers 19.16
testing 19.21.1–19.21.4
transfer of personnel 31.12.7–31.12.8, 13.13.1
tyres 20.2.7
vehicles 19.18
winches 17.5.5, 19.13

- wires 19.4.3
 - see *also* cranes; derricks
- lifts 19.21, 23.2.7
 - bosun's chair 17.5.4
 - maintenance and testing 19.21
 - offshore installations 31.6.2
 - permits to work A14.1
- lighting
 - battery compartments 20.16.3
 - cargo spaces A11.2, 28.5
 - display screen equipment (DSE) 33.2.4
 - offshore installations 31.3.3
 - portable lights 11.5.7–11.5.8, 15.11.5, 24.2.8
 - safe movement 11.2.2, 11.5
 - security lighting 6.4.1, 6.4.3
 - standards A11.2
 - welding A24.1
 - work equipment 18.18
- links 19.4.3
- liquefied/liquid petroleum gas (LPG) appliances 23.4
- litter 11.13.2
- livestock 27.12.3
- living on board 3.1–3.12
 - cold climates 3.8
 - common personal injuries 3.12
 - fatigue (tiredness) 3.6
 - hazardous substances 3.11
 - health and hygiene 3.2
 - hot climates 3.7
 - housekeeping 3.10
 - malaria 3.5
 - medication 3.4
 - sharps 3.14
 - shipboard housekeeping 3.10
 - smoking 3.3
 - sunglasses 3.13
 - working clothes 3.9
- loading
 - cargo 28.1.5
 - containers 31.6.7
 - dangerous goods 28.2.3
 - offshore installations 31.6.4, 31.6.7
- logs 15.4.2, 18.2.5, 28.4.17
- long-links 4.4.18
- LPG (liquefied/liquid petroleum gas) appliances 23.4

luggage 31.13.13; *see also* baggage

machinery

- auxiliary 20.7
- catering equipment 23.7
- electrically operated 20.5.1
- hydraulic-operated 20.5.1
- maintenance 20.5
- painting work 25.4
- permits to work A14.1
- refrigeration 20.9
- safety guards 20.2.4
- steam-operated 20.5.1
- storage batteries 20.16
- work on 20.1.1–20.22.5
- workshop and bench 18.23
- see also* laundry equipment; work equipment

machinery spaces 5.5, 20.3

- staging 17.4.9
- unmanned 20.4
- work in 20.3.3

maintenance

- access equipment 22.7
- apparatus on extension runners or bench 20.19
- auxiliary machinery and equipment 20.7
- boilers 20.6.1–20.6.11
- breathing apparatus 15.13.9–15.13.10
- drains 11.3.2
- electrical equipment 5.3.1, 5.3.7, 20.12, 29.1.8
- equipment for entry into dangerous spaces 15.6.3–15.6.4
- floor plates and handrails 20.2.5, 20.2.6
- gangways 11.2.1
- gratings 11.4.4
- hatch covers 16.2.1, 16.2.5–16.2.6
- high-voltage systems 20.12.2
- hydraulic equipment 20.11
- life-saving appliances 4.4.21
- lifting equipment 19.4, 19.21
- lifts 19.21
- lighting facilities 11.5.4
- machinery 20.5
- passageways 11.2.1
- personal protective equipment 8.2.6, 8.2.8, 8.6.4
- pneumatic equipment 20.11
- radio and associated electronic equipment 20.20

- ship-board vehicles 11.2.5
- sprinkler system 20.2
- steering gear 20.10
- storage batteries 20.16.3, 20.16.8
- switchboards 20.7.1, 20.13.1
- thermal oil heaters 20.6.1
- towing equipment 26.5.2
- work equipment 18.2.4–18.2.5
- working cargo 28.4.3
- malaria 3.5
- manholes 11.13.2, 20.3.7
- manual handling 3.12.9, 10.1–10.4.13, A10.1
 - anchors 31.16.8
 - carrying 10.3.2
 - clothing 10.4.11
 - Company duties 10.3.1–10.3.4, A10.1
 - footwear 10.4.10
 - lifting 10.3.4, 10.4.1, 10.4.4
 - pushing and pulling 10.4.5–10.4.7
 - putting down 10.2.1, 10.4.3
 - resting 10.4.12, 31.6.10
 - risk assessment 10.1.1–10.1.2, 10.3.1–10.3.2, 10.3.3
 - rolling 10.4.5
 - ropes and hawsers 3.12.2
 - techniques 10.4
 - training 10.3.1
- Marine Accident Investigation Branch (MAIB) 13.3.8.4, 13.5.4, 13.8.1
- Marine Equipment Directive (MED) A22.1/4.2
- masts 18.3.3, 19.4.3
- medical care 3.2.7
- medical emergencies 2.3, 3.2.7, 28.2.5–28.2.6
- medical fitness 3.2.1
- medical surveillance 7.4.6
- medication 3.4
 - display screen equipment use 33.2.5
 - malaria 3.5.1
- meter probes 20.12.7
- microwave ovens 23.6
- microwave radiation 23.6.2
- mineral oils 3.11.5
- mobile lifting appliances 11.9.1
- mooring 3.12.10, 26.3.4
 - boarding 22.8.4
 - bights 3.12.10
 - bollards 3.12.10

- buoys 26.4
- drum ends 3.12.10, 26.3.16
- equipment inspection 26.3.7
- making fast and casting off 26.3
- mooring layout 26.3.11
- mid-ships 26.6.5
- ropes 10.4.8
- single point 26.6.6
- slip wires 26.4.4
- small, domestic passenger craft and launches A26.2
- snap-back zones 26.3.2–26.3.3, 26.3.13, 26.3.15, 24.6.4, A26.1
- training 26.1.1

multimeters 15.3.3

musters and drills 4.1–4.12

muster lists 4.1.3

mutagens 21.2

National Maritime Occupational Health and Safety Committee 1.2.7

needles see sharps

noise 12.1–12.17

- consultation 12.3
- exposure to 12.2, 12.5, 12.6, 20.3.4
- health surveillance 12.8
- information and training 12.4
- music and entertainment 12.9
- noise levels A12.1, A12.2
- offshore oil and gas installations 31.4.4
- personal hearing protection 12.6.3, 12.6.6
- risk assessment 12.1.2–12.1.3, 12.7
- roll-on/roll-off ferries 27.5
- safety signs 12.7.5
- work equipment 18.22.10

oars, lifeboats 4.4.17

occupational health and safety 1.1–1.2.8

- accountability 1.2.6, 1.2.8, 3.6.3, 13.1.1–13.1.2
- communications 1.2.2
- cranes 31.6.11
- expectations 1.2.1
- incident investigation 1.2.8
- induction process 1.2.1
- just culture 1.2.6
- knowledge management 1.2.8
- leadership 1.2.3
- planning 1.2.4

- risk awareness and assessment 1.2.5, 12.1.2–12.1.3
- safe movement 11.13.1
- safe working culture 1.2
- safety induction 2.1.1
- signs 9.1.1
- smoking 3.3.1
- towing 30.6
- work equipment 18.1.8
- occupational medicine 7.3.1, 7.7.2, 7.8
- off-load/on-load release arrangements 4.4.12
- offshore installation manager 31.2.3
- offshore installations, ships serving 31.1.1–31.16.17
 - anchor handling 31.16
 - approaching 31.8
 - bulk cargo operations 31.7
 - cargo-handling operations 31.8
 - carriage of cargo 30.6
 - communications 30.5
 - personal protective equipment 30.4
 - precautions 31.3
 - responsibilities 31.2
 - transfer of personnel by gangway 31.14
 - transfer of personnel by ship 31.9
 - transfer of personnel to installation by basket 31.13
 - transfer of personnel to installation by personnel carrier 31.11
 - transfer of personnel to installation by specialist craft 31.10
 - transfer of personnel to installation by transfer capsule 31.12
- offshore renewable energy installations (OREIs)
 - access 32.4
 - boarding arrangements 32.4
 - cargo carriage and transfer 32.5
 - Company duties 32.2.2
 - coordination between organisations 32.3
 - diving safety 32.1.3
 - emergency response plans 32.6
 - personnel responsibilities 32.2
 - risk assessment 32.3.3–32.3.4, 32.4.2
 - safety officials 32.2
 - safety responsibilities 32.2
- offshore support vessels 31.5
- oil and bulk ore/oil carriers 29.2
- oil-fired stoves 23.3.1, 23.3.2, 23.4.5
- oil fires 4.3.4
- oil pollution 4.11.2
- oil tanks 20.3.7

- oils
 - boilers 20.6.7
 - cooking oil 5.6.1, 5.6.2, 23.5.1–23.5.3
 - leakages 5.5.1, 20.3.5–20.3.6
 - mineral oils 3.11.5
 - spillages 11.4.2, 11.13.2
 - storage 5.5.3
 - toxicity of 15.4.4–15.4.6
 - vapours 29.2.2
 - waste 20.3.6, 2.6.3
- openings
 - guarding of openings 11.2.4, 11.6, 20.2.5
 - manholes 11.13.2, 20.3.7
- overalls 3.9.2, 8.4.1
- oxygen
 - dangerous (enclosed) spaces 4.8.3, 8.8.1, 8.8.8, 8.8.13, 11.10.1
 - engine starting 20.7.6
 - gas welding 24.3.1, 24.9.22
 - oxygen deficiency testing 15.3.3, 15.6.6–15.6.7
- packaging 3.11.2, 27.9.8
- painting 25.1.1–25.4.10
 - application of new paint 25.3
 - paint-spraying equipment 25.4
 - preparation and precautions 25.2
- pallets 28.4.15, 28.4.20
- pantries 5.6.1, 23.1.2
- passenger ships
 - mooring to quays 26.6, A26.2
 - muster lists 4.1.3
 - security 6.2.1
 - see also* roll-on/roll-off ferries
- pedestrians 27.6.1–27.6.2
- permit to work systems 14.2, A14.1, A14.1.3, 18.16.1, 18.16.2
 - dangerous (enclosed) spaces A14.1.1, 15.1.4, 15.3.1, 15.7.1, 15.9.3, 15.10.1
 - electrical high voltage systems 20.14.2, 20.14.13
 - entry into enclosed or confined space A14.1, A14.1.1, 15.1.3, 15.1.4
 - gas testing/equipment A14.1
 - general electrical (under 1000 volts) A14.1
 - hazard identification 14.2.1
 - hot work A14.1
 - isolation from sources of energy 18.16.1, 18.16.2
 - lifts A14.1, 19.21.7
 - machinery or equipment A14.1

- moveable bulkheads 28.7.7
- principles 14.2.3
- sanction to test systems 14.3.1–14.3.3, A14.2
- switchboards 20.13.1–20.13.2
- unmanned machinery spaces 20.4.1
- working at height/over the side A14.1, A14.1.2
- personal atmosphere monitors ('multimeters') 15.3.3
- personal cleanliness 29.1.4
- personal protective equipment (PPE) 12.2.3, 18.1.9
 - body protection 8.11
 - boiler maintenance 20.6.4
 - breathing apparatus 8.8.13–8.8.14
 - chemical tankers 29.4.5
 - drowning protection 8.12, 32.4.4
 - employer duties 8.2.6
 - face and eye protection 3.12.3, 8.7, 15.14.7, 18.24.11, 20.20.3, 21.5.4, 21.5.5
 - falls protection 8.10
 - gas monitors 8.8.9–8.8.12
 - hand and foot protection 8.9
 - hazardous substances 15.11.6, 21.1.6, 28.2.7
 - head protection 8.5
 - hearing protection 8.6, 18.22.10
 - heavy weather 11.12.4
 - hot work 24.4
 - inspection 8.2.9
 - jetting equipment 18.25.6
 - maintenance 8.2.8
 - making fast and casting off 26.3.1
 - offshore installations 31.3.1, 31.4, 31.9.3, 31.10.10, 31.13.1
 - painting 25.2.3
 - resuscitators 8.8.15
 - respiratory protective equipment 8.8, 15.13
 - roll-on/roll-off ferries 27.6.3
 - seafarer duties 8.3
 - towing 26.5.4, 30.6.4
 - training 8.2.7
 - types of equipment 8.4
 - welding 24.4.1–24.4.2
 - worker duties 26.5.4
- personnel alarms 20.4.6
- personnel baskets 31.13
- personnel capsules 31.12
- personnel carriers 31.11
- pesticides 21.7

- petroleum 29.2.1
- pilots
 - boarding arrangements 22.9, A22.1/4.2–A22.1/4.9
 - pilot boat 22.9.5
 - pilot ladders 22.9.2, A22.1/4.2– A22.1/4.9
- pipelines 9.8
 - colour coding 9.8
 - fire precautions 24.2.6–24.2.7
 - hot 3.12.6
- piracy 6.7
- planks 17.3.7, 17.4.2, 17.6.1
- pneumatic equipment
 - jetting equipment 18.25
 - maintenance 20.11
 - tyres 20.2.7
- pollutants 4.12.4
- pollution prevention training 2.1.4
- pontoons 15.4.2, 16.5.1
- port towage industry 30.1.1–30.9.2
 - bridle/gog rope 30.5
 - communications 30.7
 - escorting 30.9
 - interaction 30.8
 - seafarer safety 30.6
 - towing equipment testing and inspection 30.3
 - towing gear connecting and disconnecting 30.4
- power systems 20.1.1–20.22.5
- power take-off shafts 18.32
- punts 17.6.1–17.6.4
- pushing and pulling 10.4.5–10.4.7
- putting down 10.2.1, 10.4.3

- radar scanners 17.2.11
- radiation 20.20.13, 24.7.3
- radios
 - anchoring operations 26.2.2
 - life-saving appliances 4.4.7
 - maintenance 20.20
 - offshore installations 31.5.2–31.5.3
 - portable radio 26.2.2, 26.3.1
- ramps 27.7.1, 27.7.3–27.7.4
- rats 3.2.6
- razor blades see sharps
- record keeping
 - accident investigation 13.8.3, 13.8.6, 13.8.10, 13.8.12

- accidents and dangerous occurrences 13.3.7, 13.4.5, 13.4.6.2
- drills 4.8.5
- fatigue prevention 3.6.3
- hazardous substances 21.3.4, 21.3.6, 21.4.3
- health and safety 13.2.6
- health surveillance records 7.2.2, 7.4.2–7.4.3, 7.4.6, 7.7.2, 7.7.3
- noise assessment 12.2.5
- occupational diseases 7.8.2
- personal protective equipment 8.2.6, 8.2.7, 8.2.9
- physical agents 12.2.5
- safety committees 13.3.4.2, 13.3.4.5, 13.7.5, 13.7.8, 13.7.9, 13.7.11
- safety inspections 13.4.4.3
- safety officers 13.3.2.1, 13.3.3.4, 13.4.1.2, 13.4.3.1, 13.5.4
- work equipment 18.3.5
- refrigerated spaces 23.9, 28.2.9
- refrigeration machinery and compartments 20.9
- remote controls 4.2.5, 20.3.10
- renewable energy installations *see* offshore renewable energy installations (OREIs)
- rescue
 - enclosed and confined spaces 15.8.3, 15.8.7
 - equipment 15.8.3, 15.14
 - lifting equipment 19.11.4
 - offshore installations 31.9.5
 - rescue boats 4.4.11, 4.4.15, 4.6.3–4.6.6, 4.6.11
 - work at height/overside A17.1/3–A17.1/5
- respiratory protective equipment 3.7.6, 8.8
 - respirators 8.8.4–8.8.8, 25.4.5
- resuscitation equipment 15.13, 15.8.3
- resuscitators 8.8.15, 28.2.10
- rings 19.4.3
- risk assessment 1.2.5, A1.2
 - adverse weather 11.12.4
 - anchors 31.16.17
 - boarding arrangements 22.8.6
 - dangerous (enclosed) spaces 15.1.6, 15.2.3–15.2.5, 15.8.4
 - hazard identification 1.2.5, A1.2
 - hazardous substances 21.1.4, 21.1.8
 - hazards to crew A1.2
 - health and safety 8.1.1
 - hot work A24.1
 - keeping workers informed 1.2.5
 - key terms 1.2.5
 - lifting equipment 19.21.5–19.21.6
 - liquid cargoes 29.1.2

manual handling 10.1.1–10.1.2, 10.3.1–10.3.2, 10.3.3
mooring 26.1.2, 26.3.11, 24.6.3
moveable bulkheads 28.7.3
noise 12.1.2–12.1.3, 12.7, 12.8.1
occupational health and safety 1.2.4–1.2.5
offshore installations 31.3.4–31.3.5, 31.9.7
offshore renewable energy installations (OREIs) 32.3.3–32.3.4, 32.4.2
painting 25.3.1
personal assessment of risk 1.2.5
port towage industry 30.1.2
principles of risk assessment A1.2
process of risk assessment 1.2.5
recording findings A1.2
reviewing risk assessment A1.2
risk assessment in practice 1.2.5
risk awareness 1.2.5
rope access and positioning A17.3
safe movement 11.12.4
safety inspections 13.2.6.1, 13.4.4.4, 13.5.3
security plans 6.2.1
switchboards 20.13.2–20.13.3
task-based risk assessment (TBRA) 1.2.5
toolbox talk 1.2.5
transfer of personnel 31.9.7, 31.13.1
what should be assessed? 1.2.5
work equipment 18.4, 18.14.2–18.14.3, 18.22.11

robbery 6.7

roll-on/roll-off ferries 27.1.1–27.13.5
Code of Practice on the Stowage and Securing of Vehicles on
Roll-on/Roll-off Ships 27.6.2
dangerous goods 27.11
fire safety/prevention 27.4
housekeeping 27.13
noise 27.5
pedestrians 27.6.1–27.6.2
safe movement 27.6
securing of cargo 27.10
smoking 27.2.2
stowage 27.9, 27.3.2, 27.10.19, 27.10.21
vehicle decks 27.2.1–27.6.3
ventilation 27.3.1–27.3.2
work equipment 27.7

ropes 11.13.2
access and positioning techniques A17.3
bights 3.12.2, 3.12.10, 19.14.3, 19.14.4, 26.3.10, 26.3.12, 26.5.6

- breaks 18.34.5
- bridle/gog rope 30.5
- bulldog grips A18.2
- inspection 18.2.3
- lifting equipment 19.4.3, 19.11.12, 19.11.13, 19.11.16–19.11.18, 19.20.4, A19.1.1
- man-made fibre ropes 18.33.4, 18.34
- mechanical fastenings 18.34.8
- mooring 3.12.10, 26.3.5–26.3.6, 26.3.8, 26.3.16, 26.3.17, 23.3.18
- obstructions 11.4.7
- pilot access A22.1/4.5
- polyamide ropes 18.34.7
- polypropylene ropes 18.33.5, 18.34.6
- resistance to chemicals 18.33.2
- safety rope 12.10.2
- snap-back zones 26.5.6
- splices 18.34.7
- steel wire ropes 18.33.8
- stoppers 18.34.9
- storage 18.33.3
- stretching 18.34.5
- towing 18.34.5, 30.4.2
- wire ropes 19.11.3, 19.11.13, A19.1.4, 26.3.8–26.3.9, 28.1.9

- safe movement 11.1–11.13, A11.1–11.2
 - adverse weather 11.12, 31.16.6
 - anti-slip decks 26.3.6
 - deck working at sea 11.11
 - drainage 11.3
 - entry into dangerous (enclosed) spaces 11.10
 - footwear 11.13.2
 - guarding of openings 11.6
 - hold access standards A11.1
 - ladders 11.8.2–11.8.5
 - lighting 11.5, A11.2
 - non-slip flooring/decks 26.3.6
 - roll-on/roll-off ferries 27.6
 - stairways 11.8.1
 - transit areas 11.4
 - vehicles 11.9
 - watertight doors 11.7
- safe working load (SWL) 19.12
- safety committees 13.3.5.3, 13.3.8.1, 13.4.1.2, 13.7
- safety culture 1.2.7, 33.1.3
- safety data sheets (SDSs) 21.1.4

- safety guards
 - cranes 19.13.6
 - openings 11.2.4, 11.6
 - work equipment 18.8.1–18.8.2, 18.22.2, 18.22.8, 18.23.1, 18.24.7, 20.3.4
- safety harnesses 4.6.4
- safety helmets 8.5.1–8.5.3
- safety induction 1.2.1, 2.1–2.9
 - accidents and medical emergencies 2.3
 - company and worker responsibilities 2.8
 - consultation procedures 2.9
 - emergency procedures and fire precautions 2.2
 - environmental responsibilities 2.6
 - familiarisation training 2.1
 - good housekeeping 2.5
 - health and hygiene 2.4
 - induction programmes 2.1.2
 - occupational health and safety 2.7
- safety lines 22.9.3
- safety locks 20.14.2
- safety nets
 - boarding arrangements 22.3
 - cargo stowage 28.6.5
 - working at height 17.2.6
- safety officers
 - accident investigation 13.8
 - appointment 13.3.2
 - checklist for inspection 13.4.4.5, A13.1
 - duties 13.4.1–13.4.6.3
 - investigation of accidents and dangerous occurrences 13.4.3–13.4.3.2
 - promotion of safety 13.2.1
 - recommendations 13.2.2.2, 13.2.2.3
 - record keeping 13.4.5–13.4.5.1
 - regulations 13.4.2.1, 13.4.4.7
 - role 13.4.2.2
 - safety committee 13.3.5.3, 13.3.8.1, 13.4.1.2
 - safety inspections 13.4.1.2, 13.4.4–13.4.4.7
 - termination of appointment 13.3.5–13.3.5.4
- safety officials 13.1–13.8.2
 - appointment 13.1.4
 - company duties 13.3
 - employer duties 13.2, 32.2.2
 - information provision 13.2.3
 - offshore renewable energy installations (OREIs) 32.2
 - record keeping 13.2.6

- regulations 13.3.7.1
- representations 13.2.5, 13.3.2.3, 13.3.3.3, 13.3.4.3, 13.3.8.1–13.3.8.2, 13.4.4.6, 13.5.3
- responsibilities 13.3.2.2, 13.4.2.2, 13.4.6.1, 32.2
- safety culture 13.1.3
- support 13.3.6–13.3.6.3
- termination of appointments 13.3.5–13.3.5.4
- training 13.3.2.2
- workers' representatives 13.2.4–13.2.7
- workers' representatives elections 13.3.1.1, 13.3.3–13.3.3.6
- safety representatives
 - advice 13.6
 - investigations and inspections 13.5.2, 13.5.4
 - powers 13.5
 - problems 13.6.5
 - recommendations 13.6.3
- safety signs 9.1–9.9, A9.1, 11.2.3
 - colours 9.3.1, 9.4.1, 9.6.2, 9.7.2, 9.8.1, 9.9.4, 11.4.5
 - blue 9.4.8
 - green 9.4.9
 - red 9.4.4, 9.9.2
 - yellow 9.4.7
 - dangerous (enclosed) spaces 15.1.8
 - duty to display 9.2
 - deep fat fryer fires 23.3.2
 - electrical high voltage systems 20.14.2, 20.14.12
 - electrical wiring 9.6
 - emergency escape A9.1 Part 4
 - fire extinguishers 9.9
 - firefighting A9.1 Part 5
 - fumigation warning 21.7.6
 - galleys 23.5.9
 - gas cylinders 9.7, 24.8.3
 - gas detection alarms 23.4.1
 - hazardous substances and mixtures 21.1.3
 - illuminated signs 9.5.1–9.5.2
 - labels 21.5.2
 - languages 9.1.3
 - lifts 19.21.9
 - machinery spaces 20.4.3, 20.5
 - mandatory signs 9.4.3, 9.4.8, A9.1 Part 3
 - markings 18.19
 - noise 12.7.5
 - occasional signs 9.5
 - permanent signs 9.4.3

- pipelines 9.8
- prohibitory signs 9.4.4, A9.1 Part 1
- signs and notices 9.4
- supplementary signs 9.4.10
- symbols 9.4.2
- warning signs 9.4.7, 18.20, 20.2.4, A9.1 Part 2
- watertight openings 30.2.2
- work equipment 18.25.6, 20.20.7
- worker duties 9.3
- working at height 17.2.8, 17.2.10–17.2.13
- safety zones 31.7.2, 31.8.3–31.8.5, 31.10.8
- satellite terminal antenna 20.20.2
- saturation chambers 15.1.5
- saws 18.21.4
 - meat saws 23.8.3, 23.8.8
- scaffolding 17.7.1–17.7.7, A17.4, 31.6.9
- scalds 3.12.7, 23.2.1
- scuppers 11.3.1, 27.13.5
- seafarer duties
 - emergency duties 15.12
 - hazardous substances 21.5.3
 - health and safety 1.1
 - manual handling 10.4.8
 - personal protective equipment 26.5.4
 - pollution-prevention 2.1.4
 - safety induction 2.1.1
 - safety signs 9.3
 - work equipment 18.7.1
 - working cargo 28.4
- seafarer information and training
 - biological agents 21.8.3
 - dangerous (enclosed) spaces 15.2.6, 15.12
 - display screen equipment (DSE) 33.2.2
 - emergency procedures 28.2.5, 29.1.3
 - laundry equipment 18.35
 - manual handling 10.3.1
 - moveable bulkheads 28.7.5
 - noise 12.4
 - personal protective equipment 8.2.7, 29.4.5
 - pollution prevention 2.1.4
 - roll-on/roll-off ferries 27.7.2
 - safety 10.3.1
 - watertight doors 2.1.1, 11.7.1
- security 6.1–6.9
 - international terrorism 6.5

- personnel joining and leaving the vessel 6.9
- piracy and armed robbery 6.7
- precautions 6.4
- security levels 6.3
- ship security officer (SSO) 6.2.4, 6.3.1
- ship security plan (SSP) 6.2
- patrols 6.4.3
- smuggling 6.8
- stowaways 6.6
- watchkeepers 1.2.2
- semi-conductor devices 20.22
- semi-inserts A12.3/2
- semi-trailers 27.9.6–27.9.7, 27.10.6
- shackles 19.4.3, 19.17.2, 28.4.19
- shaft tunnels A11.1
- sharps
 - containers 3.14.11, 3.14.14, 3.14.16
 - injuries 3.14.18
 - removal of 3.14.13, 3.14.14, 3.14.15, 3.14.16, 3.14.17
 - safe systems of work 3.14.4
- sheave blocks 19.12.3
- Ship Captain's Medical Guide* 3.2.7, 3.5.4
- shoes *see* footwear
- showers 29.3.4
- shutting down procedures A24.1
- signals
 - acoustic 9.5.1
 - hand 9.5.1
 - spoken 9.5.4
- signallers 19.9.4–19.9.8, 28.4.6–28.4.7
- skips 31.6.8
- sleep 3.6.3
- slings 19.11.12, 19.15.1, 28.4.9, 28.4.14, 28.4.15, 28.4.16, 28.4.21–28.4.22
- slips 23.2, 31.16.5
- sludge 15.5.3
- smoking 2.2.2, 3.3, 3.11.6
 - battery compartments 20.16.2
 - dry-cleaning operations 21.6.1
 - e-cigarettes 2.2.2, 5.2.1
 - fire precautions 5.2
 - food preparation and handling 23.1.2
 - painting 25.2.4
 - prohibitory signs 9.4.5
 - roll-on/roll-off ferries 27.2.2
 - tankers and bulk carriers 29.1.6

- vehicle decks 27.2.2
- smuggling 6.5, 6.8
- snap-back zones 26.3.2–26.3.3, 26.3.13, 26.3.15, 26.5.1, 26.6.4, A26.1
- solvents 3.11.5, 20.2.7, 20.3.11
 - dry-cleaning operations 21.6.1–21.6.2
- sparks 24.2.3–24.2.5, 24.6.9, 24.7.3, 29.1.9
- spectacles 8.7.2, 8.8.3
- spillages 11.4.2, 11.13.2, 29.1.7
 - dangerous goods 28.2.8, 28.2.9, 28.2.10
 - drills 4.11
 - dry-cleaning operations 21.6.2
 - roll-on/roll-off ferries 27.13.2
- spontaneous combustion 5.4
- spraying operations 21.7.3
- stages 17.4.1–17.4.11
- stairways 11.8.1, 11.13.2, 23.2.5, 27.9.4
- stanchions 17.4.1
- standards see Appendix 3 for British Standards and International Standards
- starting controls 20.7.2, 20.8.2
- steam 11.5.3, 23.5.1
 - steam boilers 23.3
 - steam pipes 5.4.2, 20.3.2, 20.5.4
 - steam-operated machinery 20.5.1
 - steamers 23.3.5, 23.3.8
- steering gear 20.10
- stern thrusters 17.6.3
- stop controls 18.12–18.13
- ‘stop work authority’ 1.2.1
- stoppers 19.16
- storerooms 4.2.3, 23.9
 - spontaneous combustion 5.4.2
- stowage 5.4.2, 20.3.12
 - containers 28.3.7
 - cranes 19.8.3
 - dry cargo 28.1
 - offshore installations 31.6
 - roll-on/roll-off ferries 27.9
- stowaways 6.6
- stress A33.1
- sunburn prevention 3.7.5
- sunglasses 3.13
 - eye damage 3.13.1
 - lenses 3.13.3, 3.13.4, 3.13.5
 - prescription 3.13.6
 - tints 3.13.3

- supplies
 - consumables 20.3.15
 - tools 20.3.14
- survival craft 4.1.3, 4.1.4, 4.1.15
- survival suits 4.6.8
- suspension syncope A17.1/4
- switchboards 20.5.7, 20.7.1, 20.13, 20.14.5
- syringes see sharps

- tag lines 31.3.4, 31.13.1
- tank vehicles 27.11.4, 27.12.2
- tankers 29.1.1–29.4.6
 - chemical carriers 29.4
 - liquefied gas carriers 29.3
 - oil and bulk ore/oil carriers 29.2
- tanks
 - coatings 15.4.12
 - controls 20.3.10
 - filling 20.3.8
- tarpaulins 16.5.3
- temperature, extreme 18.10
- tenders 22.8.3
- terrorism 6.1.1, 6.5
- tests
 - alarm bells 23.9.2
 - atmosphere 27.3.3
 - auxiliary machinery and equipment 20.7
 - diesel engines 20.7.5
 - electrical equipment 20.12.6
 - electrical high-voltage systems 20.14.2
 - eye tests 33.2.3
 - fire drills 4.2
 - health surveillance 7.3, 7.4.4, 7.7.2
 - hot work 24.2.7
 - lifting equipment 19.4.3, 19.19, 19.21.1–19.21.4
 - lifting equipment certificates of test 19.6, A19.1–A19.1.4
 - lifts 19.21
 - oxygen deficiency 15.3.3, 15.6.6–15.6.7
 - remote controls 4.2.5
 - sanction to test systems 20.14.2
 - survival craft drills 4.1.4
 - towing equipment 26.5.2, 30.3
 - toxic gases 23.4.1
 - work equipment 18.2.3
- tiredness 3.6

toe-boards 17.4.1
toilets
 . cleaning products 21.1.7
 . drainage 11.3.1
tools 18.1.9
 abrasive wheels 18.24
 accessories 18.22.7
 battery compartments 20.16.10
 carrying tools 11.8.1
 double-insulated 18.22.5
 engine room 20.3.14
 hand tools 18.21
 hydraulic jacks 18.29
 hydraulic/pneumatic/high pressure jetting equipment 18.25
 oxy-acetylene cutting gear 31.16.15
 portable power tools and equipment 18.22
 safety guards 18.22.8
 storage of 3.12.8
 suitability of tools A33.1
 working at height 17.2.14–17.2.15
 workshop and bench machines (fixed installations) 18.23
 see *also* work equipment
torches 11.12.5, 15.8.3, 20.6.7, 27.10.9
towing
 bights 26.5.6
 bollards 26.3.11, 26.3.17, 26.5.5, 26.5.8
 bridle/gog rope 30.5
 communications 30.7
 connecting and disconnecting towing gear 30.4
 interaction 30.8
 seafarer safety during towing operations 30.6
 snap-back zone 26.5.1
 testing and inspection towing equipment 26.5.2, 30.3
toxic substances
 chemicals 15.6.12, 29.4.2
 gases 27.3.3
 oil 15.4, 29.2.2
tracked vehicles 27.12.2
training see worker information and training
transformers 20.14.14
transit areas 11.4, A11.2
transmitters 20.2.2, 20.20.7
trips 23.2, 31.16.5
trolleys 10.4.6, 10.4.7, 10.4.9, 24.8.1
trucks 19.18

- tugs 26.5.3–26.5.6, 27.10.8
 - bridle/gog rope 30.5
 - communication 26.5.7, 30.7
 - crew safety during towing operations 26.5.4, 30.4.2–30.4.4, 30.6
 - escorting 30.9
 - hazards 30.8.2
 - interaction 30.8.1
- turbines, cleaning 20.5.2
- 'tween decks 28.1.11

- unloading 11.2.2, A11.2, 28.1.3, 28.1.5, 28.1.10, 28.2.3, 31.6.13
 - roll-on/roll-off ferries 27.3.2, 27.10.19, 27.10.21

- vaccinations 2.4.2, 3.4.3
- valves
 - cleaning/replacement 20.5.2
 - dangerous (enclosed) spaces 15.5.2
 - gas welding and cutting 24.8.2, 24.8.4, 24.9.4, 24.9.6, 24.9.8, 24.9.21, A24.1
 - radio 20.22
 - steam-operated machinery 19.3.3–19.3.4, 20.5.1
- vapours
 - dry-cleaning operations 21.6.1
 - flammable 15.4.14–15.4.15
 - oil and bulk ore/oil carriers 29.2.2
 - toxic 20.20.5
- vehicles
 - lifting equipment 19.18
 - roll-on/roll-off ferries 27.6.2–27.6.3, 27.8, 27.11.2–27.11.4
 - safe movement 11.2.5, 11.9
- ventilation
 - dangerous (enclosed) spaces 15.1.7, 15.9.1
 - dry-cleaning operations 21.6.1
 - electrical fittings 5.3.8
 - fires 4.2.5, 4.3.9, 4.12.10
 - hot environments 3.7.3
 - painting 25.2.4
 - refrigeration machinery 20.9.3
 - roll-on/roll-off ferries 27.3
 - spontaneous combustion 5.4.2
 - storage batteries 20.16.15
 - work equipment 18.29.3, 24.9.22
- vessels, small 22.11, 26.6
 - safe access to 22.11.1–22.11.3
 - transfer by 31.10

- vibration 12.10–12.17
 - consultation 12.3
 - determining levels 12.12
 - exposure limits 12.11
 - hand–arm 12.10.1, 12.14.1–12.14.8, 12.16.1–12.16.3
 - health surveillance and monitoring 12.16
 - information and training 12.4
 - risk assessment 12.1.2–12.1.3
 - vibration regulations 12.11
 - white finger 18.22.11
 - whole body 12.10.2, 12.15
 - work equipment 18.22.11
- viruses 3.14
- vomiting 23.1.7

- walkways 11.2.1, 11.4.1, 11.4.6
- warning notices *see* safety notices
- waste disposal 23.1.19
- watchkeepers 1.2.2
- water
 - drinking water 23.1.12
 - galleys 23.3.3, 23.5.1
- water spray systems 4.4.8
- watertight doors and openings 4.2.9, 11.7, 11.13.2, 30.2.2
- waypoints 31.8.1
- weather, adverse 11.4.3, 11.12, A11.2
- weighing anchor 26.2.1–26.2.6, 26.6
- welding
 - arc welding 24.7, A24.2
 - blowpipes 24.9.6, 24.9.12, 24.9.14–24.9.15, 24.9.18–24.9.21
 - electric welding equipment 24.6
 - flashbacks 24.9.7
 - gas welding 24.9
 - hoses 24.9.15–24.9.16, A24.3
 - lifting equipment 19.2.5, 19.11
 - permit of work 24.2.1
 - pre-use equipment check 24.5
 - precautions against fire and explosion 24.2.3–24.2.10
 - see also* hot work
- whiplash 18.22.6, 26.5.8
- whistle 17.2.8
- winches 17.5.5, 19.13, 26.3.12
- windfarms *see* offshore renewable energy installations (OREIs)
- windlass 26.2.1, 26.2.4, 26.2.5

wires 11.12.2, 19.4.3, 19.14.4, 19.14.5, 19.14.6, 19.14.8, 19.14.9, 19.14.11,
26.3.8, 26.3.16, 26.4.4
live 31.16.12–31.16.13
work equipment 18.1.1–18.35.5
abrasive wheels 18.24
bulldog grips A18.2
control systems 18.15
controls 18.11–18.14
dangers 18.8.1–18.8.3
display screen equipment (DSE) 33.2
drive units and power take-off shafts 18.32
duty of seafarers 18.7
electrical equipment 18.9.1–18.9.2
emergency stop controls 18.3
EU requirements A18.1
fork-lift trucks 18.28
hand tools 18.21
hazards 18.1.7–18.1.8
high or low temperatures 18.10.1–18.10.2
hydraulic jacks 18.26
hydraulic/pneumatic/high pressure jetting equipment 18.25
information and instructions 18.5.1–18.5.2
inspection 18.2.2, 18.3.1–18.3.7
isolation from sources of energy 18.16
languages 18.5.2, 18.6.4
laundry equipment 18.35
lighting 22.2.6
maintenance 18.2.1–18.2.5
markings 18.19
mobile work equipment 18.29
personal protection 18.22.10
portable power tools and equipment 18.22
regulations 18.1.5
remote-controlled self-propelled work equipment 18.21
risks 18.1.6, 18.4.1–18.4.2
roll-on/roll-off ferries 27.7
ropes 18.33, 18.34
safety guards 18.8.1–18.8.2, 18.22.2, 18.22.8, 18.23.1, 18.24.7, 20.3.4
self-propelled work equipment 18.29.1, 18.30, 18.31
stability 18.17
standards 18.1.4
starting controls 20.7.2, 20.8.2
stop controls 18.12
stowage 18.1.12, 18.22.9
suitability 18.1.1–18.1.12

- tools 18.1.9
- tools and equipment 18.29
- training 18.1.10, 18.6.1–18.6.4, 21.5.7, 24.2.2
- warnings 18.20
- working at height 17.2.4–17.2.6
- workshop and bench machines (fixed installations) 18.23
- work processes 33.1.1, A33.1
- working at height/over the side A14.1.2, 17.1.1–17.7.7
 - bosun’s chair 17.5.1–17.5.6
 - cradles and stages 17.4.1–17.4.11
 - emergency planning 17.2.6, A17.1
 - equipment 17.2.4–17.2.6
 - ladders 17.3–17.3.17, A17.2
 - punts 17.6.1–17.6.4
 - ropes A17.3
 - scaffolding 17.7.1–17.7.7, A17.4
 - training 17.2.2–17.2.3
- workshop machines 18.23

- X-ray radiation 20.20.4

- young workers 1.2.5, A1.2, 12.16.3

Blank page

